

# 2026 REPUESTOS DENTALES

1ª Edición

Bienvenido



# RUMAR

mayorista dental

2004 – 2026

Mayorista dental en España y Portugal con venta exclusiva a Depósitos Dentales y Servicios Técnicos.



## ¿A qué nos dedicamos?

En RUMAR nos dedicamos desde el año 2004 a la importación de repuestos dentales y aparatología dental, y la distribución de repuestos, aparatología e instrumental médico odontológico exclusivamente a depósitos dentales y servicios técnicos.

*"Buenos precios. Gran selección. Servicio rápido."*

## Definiciones previas

**Nuestro equipo:** profesionales al servicio de nuestros socios.

**Nuestros socios:** conjunto de servicios técnicos y depósitos que confían en nosotros. Ellos son la razón de nuestro existir.

**Un buen día:** haber atendido satisfactoriamente las necesidades de nuestros socios.

## Historia

**2004:** La semilla de nuestro proyecto es plantada por Margarita Crespo y Wolfgang Ade en Cedeira – A Coruña.

**2012:** Una nueva generación liderada por Alejandro Tuimil toma el relevo de la empresa y se traslada a Collado Villalba – Madrid.

**2018:** Se inauguran las nuevas instalaciones en Alpedrete – Madrid, con más de 320 m<sup>2</sup> al servicio de nuestros socios.

## Nuestro día a día

Somos un equipo de jóvenes profesionales dedicados a garantizar el mejor servicio y asesoramiento a nuestros socios.

Simplemente dedicamos nuestro día a día a hacer que el día a día de nuestros socios (depósitos dentales y servicios técnicos) sea más fácil, y convertirnos así en su aliado clave y nunca su competidor.

Parte del equipo RUMAR está dedicado constantemente a complementar nuestro stock y a hacer posible que mañana podamos atender las necesidades de nuestros socios mejor y más rápidamente.

El resto del equipo está dedicado a que hoy por hoy nuestros socios reciban lo que necesitan, cuándo y cómo lo necesitan.

# ▶ RECOMENDACIÓN PARA SUS BÚSQUEDAS

## Estimados Clientes,

Muchas gracias por su interés en nuestros productos.

En **RUMAR** contamos con más de 1.400 referencias entre todos nuestros productos y repuestos, por lo que en ocasiones puede complicarse la búsqueda de un determinado producto o repuesto. Para esas ocasiones, he aquí algunas recomendaciones útiles.

**1.** Como podrá apreciar, nuestros catálogos y listas de precios están generados en formato PDF (Adobe Acrobat). Este formato le permite utilizar un buscador automático que le facilitará su búsqueda. Para ello solamente debe seguir los siguientes pasos:

**a.** Abra nuestro catálogo o lista de precios de "Aparatología" o de "Repuestos" en función de la naturaleza de la referencia de su interés.

**b.** En la barra de herramientas en la cabecera de su pantalla es probable que encuentre una caja de texto de color blanco, con la palabra "Find" o "Buscar" en gris claro.

**c.** Como alternativa al paso "b" y si no encuentra el cuadro de texto en cuestión, diríjase al menú de "Tools" o "Herramientas" en la cabecera del documento. Aquí encontrará la opción: "Customize Toolbar" o "Personalizar barra de herramientas". Tras pinchar en esta opción, se abrirá un nuevo menú donde podrá marcar las opciones que desea visualizar en su pantalla. Seleccione la opción "Find Toolbar" o "Barra de Búsqueda". Tras esta operación deberá aparecer en su pantalla una caja de texto de color blanco, con la palabra "Find" o "Buscar" en gris claro.

**d.** Pinche en esta caja y escriba la referencia (RUMAR) del producto o repuesto de su interés o una palabra clave relacionada. Ejemplo: si Usted está interesado en unas escobillas para el K9, pruebe escribiendo escobilla o K9, y presione intro.

**2.** Esta búsqueda le posicionará en el primer lugar de todo el catálogo o la lista donde aparezca esta referencia o palabra. Si no es lo que Usted busca, vuelva a pulsar intro, y le llevará al siguiente lugar donde aparezca esta referencia o palabra. Repita estos pasos hasta que aparezca en pantalla lo que busca o hasta determinar que no contamos con ese producto o repuesto. En este último caso, consúltenos.

En caso de que los pasos 1 y 2 no sean fructíferos, a continuación le ofrecemos una segunda alternativa.

**3.** Diríjase al índice de nuestro catálogo. En él podrá encontrar de forma esquemática grupos y subgrupos de productos que le pueden ayudar en su búsqueda.

**4.** Tras ubicar el grupo o subgrupo al que pertenezca el producto o repuesto de su interés, diríjase a la página indicada y realice la búsqueda.

**Recuerde que siempre cuenta con la alternativa de contactar con nosotros:**

- **email:** [rumarcedeira@rumarcedeira.com](mailto:rumarcedeira@rumarcedeira.com)

- **Teléfono:** 918 49 01 04

## ¿Cómo reconocer en el catálogo

las novedades, bajadas de precio, referencias bajo pedido...?

NUEVO ▶ Novedad

PRECIO MÁS BAJO ▶ Bajada de precio

BAJO PEDIDO

HASTA AGOTAR

Nuevamente **gracias por su interés** en nuestros productos,  
y mucha suerte con su búsqueda y su negocio.

 **Siempre en Stock**  
**Entrega en 24 horas** 

# 2026 REPUESTOS DENTALES

1ª Edición  
4 / marzo / 2026

## CONTACTO



### ▶ Pedidos

Teléfono: 918 49 01 04  
e-mail: pedidos@rumarcedeira.com



### ▶ Att. al Cliente

Teléfono: 918 49 01 04 / 626 327 863  
e-mail: rumarcedeira@rumarcedeira.com



### ▶ Postventa

Teléfono: 918 49 01 04 / 618 051 894  
e-mail: postventa@rumarcedeira.com

## AVISO IMPORTANTE

RUMAR® se enorgullece de ofrecer repuestos originales de marcas líderes en el sector dental como: Luzzani®, Faro®, Metasys®, Dürr®, myonic®, Sirai® y ASCO pneumatics®, Clippard®, TKD®, Nouvag®, Micron®, Woodpecker®, DTE® y DCI®.

Y para el resto de marcas, RUMAR® ofrece piezas de recambio compatibles de comprobada calidad y durabilidad.

La empresa y sus productos no tienen ninguna relación con las siguientes empresas y marcas: Kavo®, Bien Air®, NSK®, Chirana Medical®, EMS®, Acteon®, Satelec®, Mectron®, W&H®, Siemens®, Sirona®, Castellini®, B.A. International®, Fona®, Planmeca®, Morita®, Saeshin®, Marathon®, Anthos®, Stern Weber®, Cefla®, Cattani®, Lares® y Fedesa®.

- Nos reservamos el derecho de modificar precios y características técnicas sin previo aviso. Para cerciorarse de estos posibles cambios, recomendamos revisar la información de la referencia que busca en nuestra web.
- Con cualquier pedido se acepta expresamente nuestras condiciones generales de venta disponibles en nuestra WEB.



[www.rumarcedeira.com](http://www.rumarcedeira.com)



# ÍNDICE

	Página
<b>RR</b> ▶ <b>REPUESTOS ROTATORIO</b> .....	<b>8</b>
<b>Alta Velocidad</b> (Turbinas y acoplamientos...):	
- Rotores turbina dental	
- Rotores turbina laboratorio	
- Tapas botón turbinas	
- Tapas, difusores, toberas y tornillos spray	
- Otros repuestos turbinas	
- Juntas conexión turbinas, acoplamientos, micromotores	
- LEDs y bombillas Xenon turbinas y acoplamientos	
- Anillos tóricos y arandelas turbinas y acoplamientos	
- Repuestos acoplamientos	
- Rodamientos turbinas	
<b>Baja Velocidad</b> (Contra ángulos, piezas de mano, micromotores...):	
- Repuestos para contra ángulos y piezas de mano (Compatibles con KaVo®, NSK®, W&H®, Bien Air®, Sirona®, MK-dent®, Castellini®, BA Internacional®, Woodpecker® / DTE®)	
- Rodamientos para contra ángulos y piezas de mano (Compatibles con KaVo®, NSK®, W&H®, Bien Air®, Sirona®, MK-dent®, RUMAR®)	
- Repuestos para micromotores (Compatibles con KaVo®, NSK®, W&H®, Bien Air®, Sirona®, MK-dent®, Saeyang Marathon®, Marathon®)	
- Rodamientos para micromotores (Compatibles con KaVo®, NSK®, W&H®, Bien Air®, Sirona®, MK-dent®, Saeyang Marathon®, Saeshin®)	
<b>FED</b> ▶ <b>REPUESTOS FEDESA</b> .....	<b>119</b>
- Filtros para sillones Fedesa®	
- Botoneras para sillones Fedesa®	
- Válvulas, electroválvulas y otros para sillones Fedesa®	
- Muelles para sillones Fedesa®	
- Motores elevadores para sillones Fedesa®	
- Varios repuestos para sillones Fedesa®	
- Pistones para sillones Fedesa®	
<b>PSD</b> ▶ <b>NOVEDAD PISTONES SILLONES DENTALES</b> .....	<b>130</b>
- Pistones para sillones Fedesa®	
- Pistones para sillones Sirona®	
<b>RLE</b> ▶ <b>REPUESTOS LÁMPARAS EQUIPOS</b> .....	<b>132</b>
- Bombillas sillones dentales	
- Repuestos lámpara Faro® Alya	
- Repuestos lámpara Faro® Maia	
- Repuestos lámpara Faro® EDI	
- Repuestos lámpara Faro® Forma y otras	
<b>RAS</b> ▶ <b>REPUESTOS AUTOCLAVES Y SELLADORAS</b> .....	<b>142</b>
<b>RBV</b> ▶ <b>REPUESTOS BOMBAS DE VACÍO</b> .....	<b>146</b>
<b>JRJ</b> ▶ <b>JERINGAS Y REPUESTOS JERINGAS</b> .....	<b>148</b>
- Jeringas Luzzani y sus repuestos	
- Jeringas FARO® y sus repuestos	
- Jeringas económicas	
- Puntas compatibles jeringas Cefla®, Kavo®, Sirona®, Luzzani®.	

	Página
<b>ME</b>	<b>▶ MANGUERAS EQUIPO ..... 162</b>
	- Mangueras turbinas con y sin conector a equipo
	- Mangueras ultrasonidos con y sin conector a equipo
	- Mangueras micromotores con y sin conector a equipo
	- Accesorios mangueras
	- Mangueras jeringas con y sin conector a equipo
	- Mangueras pedales
<b>RV</b>	<b>▶ REPUESTOS VARIOS ..... 202</b>
	- Repuestos Micron scaler SSS
	- Repuestos pulidor bicarbonato Micron Quick Jet
	- Repuestos lámparas quirófano Derungs®
	- Repuestos Nouvag®
	- Repuestos Woodpecker® y DTE®
	- Repuestos lámparas fotocurado
<b>CR</b>	<b>▶ COMPRESORES Y REPUESTOS ..... 237</b>
	- Compresores MGF®
	- Repuestos compresores MGF®
	- Repuestos compresores Dürr®
<b>SAR</b>	<b>▶ SISTEMAS DE ASPIRACIÓN Y REPUESTOS ..... 251</b>
	- Motores aspiración Luzzani® Dental y repuestos
	- Motores aspiración, centrifugadoras y separadores de amalgama METASYS®
	- Válvulas y accesorios METASYS®
	- Repuestos aspiraciones METASYS®
	- Conectores META connect (METASYS®)
	- Motores aspiración, centrifugadoras y separadores de amalgama Dürr® Dental
	- Repuestos aspiraciones Dürr® Dental
	- Conectores Dürr® connect
	- Soportes aspiración Luzzani® Dental
	- Mangueras y tubos aspiración
	- Terminales de aspiración y adaptadores
<b>PR</b>	<b>▶ PEDALES Y SUS REPUESTOS ..... 287</b>
<b>RCE</b>	<b>▶ RACORES, CONECTORES Y ESPIGAS ..... 293</b>
	- Racorería, conectores y llaves de paso
	- Espigas
	- Conectores de Nylon
<b>VE</b>	<b>▶ VÁLVULAS Y ELECTROVÁLVULAS ..... 308</b>
	- Válvulas (Faro®, Clippard®, RUMAR®)
	- Electroválvulas (Sirai® / ASCO NEUMATICS)
<b>RP</b>	<b>▶ REGULADORES DE PRESIÓN ..... 322</b>
	- Reguladores y accesorios
	- Repuestos depósito agua destilada
<b>HE</b>	<b>▶ HERRAMIENTAS ..... 326</b>
	- Herramientas instrumental rotatorio
	- Herramientas equipos

## ▶ REPUESTOS ROTATORIO

### **Alta Velocidad** (Turbinas y acoplamientos):

- Rotores turbina dental
- Rotores turbina laboratorio
- Rodamientos turbinas
- Tapas botón turbinas
- Tapas, difusores, toberas y tornillos spray
- Otros repuestos turbinas
- Juntas conexión turbinas, acoplamientos, micromotores
- LEDs y bombillas Xenon turbinas y acoplamientos
- Anillos tóricos y arandelas turbinas y acoplamientos
- Repuestos acoplamientos

### **Baja Velocidad** (contra ángulos, piezas de mano, micromotores):

- Rodamientos contra-ángulos, piezas de mano y micromotores clínica
- Repuestos cabezas, contra ángulos, piezas de mano, micromotores neumáticos, acoplamientos
- Anillos tóricos contra ángulos, piezas de mano, micromotores y ultrasonidos
- Rodamientos micromotores eléctricos
- Rotores, escobillas, pinzas y otros repuestos micromotores eléctricos





















# ROTORES RM

## para TURBINA

- **Rodamientos cerámicos myonic® / GRW®**, con tolerancias ABEC7 como mínimo.
- Balanceados electrónicamente.
- **Pinza de Acero** endurecido y anticorrosión.
- **Inserto** de Carburo o Acero según modelo.
- **Recubrimiento de WCC** (Wolframcardid) para una mayor vida útil de la pinza y sus componentes.
- **Aspa de Aluminio** sin plomo.
- **Concentricidad** < 0,018mm /
- **Balaceo** < 0,05mg mm.
- **Fuerza de retención mínima** 42 N.
- **Suministro incluye:** anillos tóricos y arandelas metálicas (según modelo).

(\*\*)Debido a su no disponibilidad, los rotores con (\*\*) junto a la referencia son rotores que, aunque con excelentes prestaciones, no son del mismo fabricante y / o no cuentan con rodamientos myonic® / GRW® como el resto de nuestros rotores RM. En nuestro afán por atender la demanda de nuestros clientes, hemos incorporado estos modelos de fabricantes alternativos, y a pesar de no contar con las mismas especificaciones, ofrecemos la **misma garantía: 12 meses sobre la pinza.**













Rotores compatibles turbinas KaVo®

	Modelos para KaVo®	Relacionados
 myonic	 <p>606B, 606C 625B, 625C SUPERtorque® 630B</p> <p>SUPERtorque® 630C SUPERtorque® 640B SUPERtorque® 640C</p> <p><b>Ref.: RM-2106</b> (Ref. KaVo: 0.553.5881)</p>	<p>Tapa Ref.: TT-6511 para 640 Tapa Ref.: TT-4041 para 630 Llave Ref.: HE-609</p> <p><b>148'00€</b></p>
 myonic	 <p>SMARTtorque® S605 SMARTtorque® S605C SMARTtorque® S615</p> <p>SMARTtorque® S615C</p> <p><b>Ref.: RM-2115</b> (Ref. KaVo: 1.008.4164)</p>	<p>Tapa Ref.: TT-7051 Llave Doble Ref.: HE-604</p> <p><b>148'00€</b></p>
 myonic	 <p>SUPERtorque® 650B SUPERtorque® 650C</p> <p><b>Ref.: RM-2116</b> (Ref. KaVo: 0.553.8051)</p>	<p>Tapa Ref.: TT-8061 Llave Doble Ref.: HE-604</p> <p><b>148'00€</b></p>
 myonic	 <p>CONTACTair® 632B CONTACTair® 632C CONTACTair® 632D</p> <p>Bella-Torque® 639B Bella-Torque® 639C Bella-Torque® 642B</p> <p>Bella-Torque® 642C Bella-Torque® 645B Bella-Torque® 645C</p> <p><b>Ref.: RM-2126</b> (Ref. KaVo: 0.553.6911)</p>	<p>Tapa Ref. 645: TT-7391 Tapa Ref. Resto: TT-5081 Llave Ref.: HE-609</p> <p><b>148'00€</b></p>
 myonic	 <p>Bella-Torque® 637B Bella-Torque® 637C Mira LUX 635</p> <p><b>Ref.: RM-2136</b> (Ref. KaVo: 0.553.8661)</p>	<p>Tapa Ref.: TT-8491 Llave Ref.: HE-1637T</p> <p><b>148'00€</b></p>
 myonic	 <p>SUPERtorque® 655B SUPERtorque® 655C SUPERtorque® 660B</p> <p>SUPERtorque® 660C</p> <p><b>Ref.: RM-2146</b> (Ref. KaVo: 1.000.2078)</p>	<p>Tapa Ref.: TT-2076 Llave Doble Ref.: HE-604</p> <p><b>148'00€</b></p>
 myonic	 <p>GENTLEsilence mini® 4500B GENTLEsilence mini® 4500C GENTLEsilence mini® 5000B</p> <p>GENTLEsilence mini® 5000C</p> <p><b>Ref.: RM-2154</b> (Ref. KaVo: 1.006.4564)</p>	<p>Tapa Ref.: TT-1079 Llave Doble Ref.: HE-604</p> <p><b>148'00€</b></p>
 myonic	 <p>GENTLEforce® 7000B GENTLEforce® 7000C</p> <p><b>Ref.: RM-2156</b> (Ref. KaVo: 1.000.4772)</p>	<p>Tapa Ref.: TT-2076 Llave Doble Ref.: HE-604</p> <p><b>148'00€</b></p>
 myonic	 <p>SMARTtorque® S619L SMARTtorque® S619C SMARTtorque® S609C</p> <p><b>Ref.: RM-2176</b> (Ref. KaVo: 1.008.4163)</p>	<p>Tapa Ref.: TT-2076 Llave Doble Ref.: HE-604</p> <p><b>148'00€</b></p>
 myonic	 <p>GENTLEsilence® 8000B GENTLEsilence® 8000C GENTLEsilence® 6500BR</p> <p><b>Ref.: RM-2186</b> (Ref. KaVo: 1.003.6884)</p>	<p>Tapa Ref.: TT-5525 Llave Doble Ref.: HE-604</p> <p><b>148'00€</b></p>

GARANTÍA de 12 meses sobre la pinza

SI NO ENCUENTRAS EL REPUESTO QUE BUSCAS, ¡CONSÚLTANOS!

Precios: impuestos, portes y mano de obra no incluidos.

Modelos para KaVo®		Relacionados
 myonic	 <p>MASTERtorque® Mini LUX M8700 (L/LK/LS/LY) MASTERtorque® mini M8700L</p> <p><b>Ref.: RM-2185</b> (Ref. KaVo: 3.001.9915)</p>	<p><b>Tapa Ref.:</b> TT-7051 <b>Llave Doble Ref.:</b> HE-604</p> <p><b>148'00€</b></p>
 myonic	 <p>GENTLEsilence® 6500B</p> <p><b>Ref.: RM-2187</b> (Ref. KaVo: 1.003.9664)</p>	<p><b>148'00€</b></p>
 myonic	 <p>POWERtorque® 646B POWERtorque® 646C POWERtorque® 646CP COMPACTtorque® 636B</p> <p>COMPACTtorque® 636P COMPACTtorque® 636CP (excepto 636 C)</p> <p><b>Ref.: RM-2196</b> (Ref. KaVo: 0.553.8911)</p>	<p><b>Tapa Ref.:</b> TT-8061 <b>Llave Doble Ref.:</b> HE-604</p> <p><b>148'00€</b></p>
 myonic	 <p>EXPERTtorque® E680 (Todos) EXPERTtorque® E679</p> <p><b>Ref.: RM-2168</b> (Ref. KaVo: 1.007.9313)</p>	<p><b>Tapa Ref.:</b> TT-8903 <b>Llave Doble Ref.:</b> HE-604</p> <p><b>148'00€</b></p>
 myonic	 <p>MASTERtorque® M9000 MASTERtorque® M9000L</p> <p><b>Ref.: RM-2190</b> (Ref. KaVo: 2.000.2266)</p>	<p><b>Tapa Ref.:</b> TT-5525 <b>Llave Doble Ref.:</b> HE-604</p> <p><b>148'00€</b></p>
 myonic	 <p>EXPERTtorque® E677 EXPERTtorque® E677LM EXPERTtorque® E675</p> <p><b>Ref.: RM-2170</b> (Ref. KaVo: 1.007.9457)</p>	<p><b>Tapa Ref.:</b> TT-7051 <b>Llave Ref.:</b> HE-604</p> <p><b>148'00€</b></p>

## Rotores compatibles turbinas Bien Air®

RUMAR









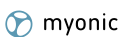

Modelos para Bien Air®		Relacionados
 	<p>Croma M Ondine Prestilina</p> <p>Prestige (antigua)</p> <p><b>Ref.: RM-2446**</b> (Ref. Bien Air: 209.30.19)</p>	<p><b>Tapa Prestige (antigua):</b> Consultar.</p> <p><b>Tapa Ondine Ref.:</b> TT-2467</p> <p><b>158'00€</b></p>
 myonic	 <p>Black Pearl Croma X S25</p> <p>Croma S Boralina Black Pearl ECO</p> <p><b>Ref.: RM-2456</b> (Ref. Bien Air: 150.0164)</p>	<p><b>Tapa Ref.:</b> TT-2459</p> <p><b>148'00€</b></p>
 myonic	 <p>Bora L Bora LED Bora LK</p> <p>Bora S36 Bora Blackline Bora Blackline LK</p> <p>Rotamax L Tornado X <b>(NO TU Bora 2 LED)</b></p> <p><b>Ref.: RM-2466</b> (Ref. Bien Air: 150.0181)</p>	<p><b>Tapa Ref.:</b> TT-2468 <b>Tapa Ref.:</b> TT-2469 <b>Llave Doble Ref.:</b> HE-802</p> <p><b>148'00€</b></p>

**GARANTÍA** de 12 meses sobre la pínza

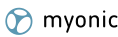
**SI NO ENCUENTRAS EL REPUESTO QUE BUSCAS, ¡CONSÚLTANOS!**

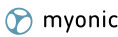
**Precios:** impuestos, portes y mano de obra no incluidos.

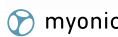
RUMAR

Modelos para Bien Air®		Relacionados
 	Prestige S30 Prestige S32  <b>Ref.: RM-2476</b> (Ref. Bien Air: 150.0486)	<b>Tapa Ref.:</b> TT-0651 <b>Llave Ref.:</b> HE-803  <b>148<sup>00</sup>€</b>
 	Eolia Black Pearl ECO <b>(Confirmar con imagen)</b>  <b>Ref.: RM-2486</b>	<b>158<sup>00</sup>€</b>
 	Tornado  <b>Ref.: RM-2468</b> (Ref. Bien Air: 150.1968)	<b>Tapa Ref.:</b> TT-1835 <b>Llave Ref.:</b> HE-831 (N/S<16E0001)  <b>148<sup>00</sup>€</b>
 	Tornado S® (cabeza mini)  <b>Ref.: RM-2470</b> (Ref. Bien Air: 150.1969)	<b>Tapa Ref.:</b> TT-1963 <b>Llave Ref.:</b> HE-846  <b>148<sup>00</sup>€</b>
 	Bora 2 LED/LK  <b>Ref.: RM-2472</b> (Ref. Bien Air: 150.3003)	<b>Tapa Ref.:</b> TT-2999 <b>Llave Ref.:</b> HE-618  <b>148<sup>00</sup>€</b>

Rotores compatibles turbinas **Sirona® / Siemens®**

RUMAR

Modelos para Sirona® / Siemens®		Relacionados
 	Siemens® TM1® Siemens® 4000ML® Siemens® 4000M®  <b>Ref.: RM-2216</b> (Ref. Siemens®: 5951595)	<b>Tapa Ref.:</b> TT-4000 <b>Llave Ref.:</b> HE-591  <b>148<sup>00</sup>€</b>
 	TS1® TS2® 4000SL®  4000S® Siemens® T1 Control®  <b>Ref.: RM-2226</b> (Ref. Sirona®: 5953054)	<b>Tapa Ref.:</b> TT-4000 <b>Llave Ref.:</b> HE-591  <b>148<sup>00</sup>€</b>
 	T1 Control (N/S<502.000) TC3 Control (N/S<65.000)  <b>Ref.: RM-2236</b> (Ref. Sirona®: 4175217)	<b>Tapa Ref.:</b> TT-7595 <b>Llave Ref.:</b> HE-592  <b>148<sup>00</sup>€</b>
 	T2 Control (N/S<600.000) T1 Control (502.000<N/S<600.000) TC3 Control (65.000<N/S<700.000)  Siropure P Control  <b>Ref.: RM-2246</b> (Ref. Sirona®: 5868299, 5957126)	<b>Tapa Ref.:</b> TT-0884 <b>Llave Ref.:</b> HE-591  <b>148<sup>00</sup>€</b>











GARANTÍA de 12 meses sobre la pinza

SI NO ENCUENTRAS EL REPUESTO QUE BUSCAS, ¡CONSÚLTANOS!

Precios: impuestos, portes y mano de obra no incluidos.

Modelos para Sirona® / Siemens®		Relacionados
	T1 Control (602.001<N/S<802.000)  <b>Ref.: RM-2238**</b> (Ref. Sirona®: 6432608)	<b>Tapa Ref.:</b> TT-5798 N/S > 600.000 <b>Tapa Ref.:</b> TT-8148 N/S > 700.000 <b>Llave Ref.:</b> HE-633  <b>148'00€</b>
 myonic	T1 Control (N/S>800.000)  <b>Ref.: RM-2248</b> (Ref. Sirona: 6710367)	<b>Tapa Ref.:</b> TT-5704 <b>Llave Ref.:</b> HE-636  <b>148'00€</b>
	T2 Control (602.001<N/S<802.000)  <b>Ref.: RM-2247**</b> (Ref. Sirona: 6432590)	<b>Tapa Ref.:</b> TT-5798 N/S > 600.000 <b>Tapa Ref.:</b> TT-8148 N/S > 700.000 <b>Llave Ref.:</b> HE-633  <b>148'00€</b>
	T2 Control (N/S>802.000)  <b>Ref.: RM-2249**</b> (Ref. Sirona: 6710425)	<b>Tapa Ref.:</b> TT-5704 <b>Llave Ref.:</b> HE-636  <b>148'00€</b>
 myonic	T2 Racer T3 Racer (N/S <600.000) Siropure P Racer (N/S <600.000)  <b>Ref.: RM-2256</b> (Ref. Sirona: 5868307)	<b>Tapa Ref.:</b> TT-8897 <b>Llave Ref.:</b> HE-591  <b>148'00€</b>
 myonic	T3 Racer (N/S>600.000) T4 Racer (N/S>600.000)  <b>Ref.: RM-2257</b> (Ref. Sirona: 6486240)	<b>Tapa Ref.:</b> TT-0212 <b>Llave Ref.:</b> HE-612  <b>148'00€</b>
 GRW	T3 Racer (N/S>800.000) T4 Racer (N/S>800.000)  <b>Ref.: RM-2270</b> (Ref. Sirona: 6727171)	<b>Tapa Ref.:</b> TT-6744  <b>148'00€</b>
 myonic	T1 mini (65.000<N/S<502.000) Siropure P mini <b>(Confirmar con imagen)</b>  <b>Ref.: RM-2260</b> (Ref. Sirona: 4178591)	<b>Tapa Ref.:</b> TT-8871 <b>Llave Ref.:</b> HE-591  <b>148'00€</b>
 myonic	T1 mini (502.000<N/S<600.000)      Siropure P mini T2 mini (N/S <600.000) T3 mini (N/S <600.000) <b>(Confirmar con imagen)</b>  <b>Ref.: RM-2261</b> (Ref. Sirona: 5868315, 5868331)	<b>Tapa Ref.:</b> TT-8871 <b>Llave Ref.:</b> HE-591  <b>148'00€</b>
 Imagen no disponible	T1 mini (600.000<N/S<700.000)  <b>Ref.: RM-2251**</b> (Ref. Sirona: 6432640)	<b>Tapa Ref.:</b> TT-0213 <b>Llave Ref.:</b> HE-592  <b>158'00€</b> <span style="float: right; background-color: #4CAF50; color: white; padding: 2px 5px;">BAJO PEDIDO</span>









**GARANTÍA** de 12 meses sobre la pinza  
**SI NO ENCUENTRAS EL REPUESTO QUE BUSCAS, ¡CONSÚLTANOS!**  
**Precios:** impuestos, portes y mano de obra no incluidos.

	Modelos para Sirona® / Siemens®	Relacionados
 <small>Imagen no disponible</small>	T1 mini CBM (700.000<N/S<800.000)  <b>Ref.: RM-2252**</b> (Ref. Sirona: 6548106)	<b>Tapa Ref.:</b> TT-8163 <b>Llave Ref.:</b> HE-634  <b>148'00€</b> <span style="float: right;"><b>BAJO PEDIDO</b></span>
 <b>GRW</b>	T1 mini (N/S>800.000)  <b>Ref.: RM-2253</b> (Ref. Sirona: 6710417)	<b>Tapa Ref.:</b> TT-5720 <b>Llave Ref.:</b> HE-635  <b>158'00€</b>
	T2 mini (602.001<N/S<702.000) T3 mini (602.001<N/S<702.000)  <b>Ref.: RM-2263**</b> (Ref. Sirona®: 6432632)	<b>Tapa Ref.:</b> TT-0213 <b>Llave Ref.:</b> HE-592  <b>148'00€</b>
	T2 mini (702.001<N/S<802.000) T3 mini (702.001<N/S<802.000)  <b>Ref.: RM-2265**</b> (Ref. Sirona®: 6548130)	<b>Tapa Ref.:</b> TT-8163 <b>Llave Ref.:</b> HE-634  <b>148'00€</b>
	T2 mini (N/S>802.001) T3 mini (N/S>802.001)  <b>Ref.: RM-2250**</b> (Ref. Sirona®: 6710441)	<b>Tapa Ref.:</b> TT-5720 <b>Llave Ref.:</b> HE-635  <b>148'00€</b>
 <small>Imagen no disponible</small>	T3 Racer mini (N/S>800.000)  <b>Ref.: RM-2268</b> (Ref. Sirona®: 6727189)	<b>Tapa Ref.:</b> TT-6751  <b>148'00€</b> <span style="float: right;"><b>BAJO PEDIDO</b></span>
 <small>Imagen no disponible</small>	T3 Racer mini (N/S>600.000)  <b>Ref.: RM-2269</b> (Ref. Sirona®: 6627124)	<b>Tapa Ref.:</b> TT-9172  <b>148'00€</b> <span style="float: right;"><b>BAJO PEDIDO</b></span>
 <b>myonic</b>	Siroboost (Todos)  <b>Ref.: RM-2262</b> (Ref. Sirona®: 6334598)	<b>Tapa Ref.:</b> TT-1439 <b>Llave Ref.:</b> HE-591  <b>148'00€</b>
	T1 Boost (N/S>600.000)  <b>Ref.: RM-2258**</b> (Ref. Sirona®: 6432624)	<b>Tapa Ref.:</b> TT-0814 <b>Llave Ref.:</b> HE-612  <b>148'00€</b>
	T1 Boost (N/S>700.000)  <b>Ref.: RM-2259**</b> (Ref. Sirona®: 6547694)	<b>Tapa Ref.:</b> TT-0836  <b>148'00€</b>

GARANTÍA de 12 meses sobre la pinza

SI NO ENCUENTRAS EL REPUESTO QUE BUSCAS, ¡CONSÚLTANOS!

Precios: impuestos, portes y mano de obra no incluidos.

Modelos para Sirona® / Siemens®		Relacionados
 myonic 	T2 Boost (602.001<N/S<702.000) T3 Boost (602.001<N/S<702.000)  <b>Ref.: RM-2264</b> (Ref. Sirona®: 6432616)	<b>Tapa Ref.:</b> TT-0814 <b>Llave Ref.:</b> HE-612  <b>148'00.€</b>
 myonic 	T2 Boost (702.001<N/S<802.000) T3 Boost (702.001<N/S<802.000) <b>(Confirmar con imagen)</b>  <b>Ref.: RM-2266</b> (Ref. Sirona®: 6548122)	<b>Tapa Ref.:</b> TT-0836 <b>Llave Ref.:</b> HE-612  <b>148'00.€</b>
 myonic 	T1 Boost (N/S>800.000)  <b>Ref.: RM-2267</b> (Ref. Sirona®: 6710409)	<b>Tapa Ref.:</b> TT-5712 <b>Llave Ref.:</b> HE-617  <b>148'00.€</b>
 myonic 	T2 Boost (N/S>802.001) T3 Boost (N/S>802.001)  <b>Ref.: RM-2254</b> (Ref. Sirona®: 6710433)	<b>Tapa Ref.:</b> TT-5712 <b>Llave Ref.:</b> HE-617  <b>148'00.€</b>

**GARANTÍA** de 12 meses sobre la pinza

**SI NO ENCUENTRAS EL REPUESTO QUE BUCAS, ¡CONSÚLTANOS!**

**Precios:** impuestos, portes y mano de obra no incluidos.









\*Las letras a continuación indican el tipo de conexión y NO influyen en el modelo de rotor en los casos indicados:

BC o C BC: Borden 3  
N o C N: NSK® MACH

RM o C RM: Midwest 4  
B o C B: Bien Air® (Unifix)

S o C S: Sirona® (Click&Go)  
M o C M: KaVo® (Multiflex)















NQ o C NQ: NSK® QD-J  
\_ o C: W&H® (Roto Quick)

	Modelos para W&H®	Relacionados
 myonic	<p>Top Air 195 Top Air 198 Top Air 398</p> <p>Top Air 698 Top Air 795 Top Air 797</p> <p>Top Air 798 Top Air 895 Top Air 898</p> <p><b>Ref.: RM-2336</b> (Ref. W&amp;H®: 02760000)</p>	<p><b>Tapa Ref.:</b> TT-4165 <b>Llave Ref.:</b> HE-606</p> <p><b>148'00€</b></p>
 myonic	<p>Top Air 196 Top Air 796 Top Air 896</p> <p><b>Ref.: RM-2345</b> (Ref. W&amp;H®: 02765500)</p>	<p><b>148'00€</b></p>
 myonic	<p>Trend TC-80 Trend TC-95 B Trend TC-95 RM</p> <p><b>Ref.: RM-2356</b> (Ref. W&amp;H®: 03305000)</p>	<p><b>Tapa Ref.:</b> TT-4165 <b>Llave Ref.:</b> HE-606</p> <p><b>148'00€</b></p>
 myonic	<p>Synea® TA-98* sin luz (tapa 2 muescas)    Alegra® TE-95 (2003-2008) Synea® TA-98L Synea® TA-98LC*</p> <p><b>Ref.: RM-2366</b> (Ref. W&amp;H®: 04396600)</p>	<p><b>Tapa Ref.:</b> TT-4168</p> <p><b>148'00€</b></p>
 myonic	<p>Synea® TA-96*</p> <p><b>Ref.: RM-2346</b> (Ref. W&amp;H®: 04396700)</p>	<p><b>Tapa Ref.:</b> TT-0096</p> <p><b>148'00€</b></p>
 myonic	<p>Top Air 290B Top Air 295 Top Air 390</p> <p>Top Air 393 Top Air 395 Top Air 695</p> <p><b>Ref.: RM-2347</b> (Ref. W&amp;H®: 04396700)</p>	<p><b>148'00€</b></p>
 myonic	<p>Alegra® TE-95* (2009-2013) Alegra® TE-98* Alegra® TE-98 C LED</p> <p><b>Ref.: RM-2386</b> (Ref. W&amp;H®: 04457300 / 05958900 / 05959000 / 0446300)</p>	<p><b>Tapa Ref.:</b> TT-9800 <b>Llave Ref.:</b> HE-606</p> <p><b>148'00€</b></p>
 myonic	<p>Synea® TA-98C LED* (tapa 2 y 3 muescas) Synea® TA-98* sin luz (tapa 3 muescas)</p> <p><b>Ref.: RM-2316</b> (Ref. W&amp;H®: 05307000 / 05306900)</p>	<p><b>Tapa Ref.:</b> TT-4166 <b>Llave Doble Ref.:</b> HE-602</p> <p><b>148'00€</b></p>
 myonic	<p>Synea® TA-97* Synea® TA-97C LED* Alegra® TE-97*</p> <p>Alegra® TE-97 C LED* (2009-2013)</p> <p><b>Ref.: RM-2326</b> (Ref. W&amp;H®: 05307200 / 05959100 / 05959200)</p>	<p><b>Tapa Ref.:</b> TT-3300 <b>Llave Doble Ref.:</b> HE-602</p> <p><b>148'00€</b></p>

GARANTÍA de 12 meses sobre la pinza





SI NO ENCUENTRAS EL REPUESTO QUE BUSCAS, ¡CONSÚLTANOS!

Precios: impuestos, portes y mano de obra no incluidos.

	Modelos para W&H®	Relacionados
 myonic	 <p>Synea® Fusion TG-97 Synea® Vision TK-97</p> <p><b>Ref.: RM-2317</b> (Ref. W&amp;H: 07006000)</p>	148'00€
 myonic	 <p>Synea® Fusion TG-98 Synea® Vision TK-98</p> <p><b>Ref.: RM-2318</b> (Ref. W&amp;H: 07005900)</p>	<p>Tapa Ref. <b>TG-98</b>: TT-4166 Tapa Ref. <b>TK-98</b>: TT-653 Llave Ref.: HE-602</p> <p>148'00€</p>
	<p>Ø aspa: 9,78mm</p>  <p>Alegria® HS2014 TE-95* (2014-actual) TE-98 LQ (Confirmar con imagen)</p> <p><b>Ref.: RM-2388</b></p>	<p>Tapa Ref.: TT-0656 Llave Ref.: HE-829</p> <p>148'00€</p>
	<p>Ø aspa: 8,66mm</p>  <p>Alegria® HS2014 TE-97* (2014-actual) TE-97 LQ (Confirmar con imagen)</p> <p><b>Ref.: RM-2389</b></p>	<p>Tapa Ref.: TT-0657 Llave Doble Ref.: HE-610, HE-829</p> <p>158'00€</p>
	<p>Ø aspa: 9,76mm</p>  <p>Alegria® HS2014 TE-98* (2014-actual) (Confirmar con imagen)</p> <p><b>Ref.: RM-2390</b> (Ref. W&amp;H: 06787501)</p>	<p>Tapa Ref.: TT-0656 Llave Ref.: HE-829</p> <p>158'00€</p>
 myonic	 <p>RC-95BC RC-95BM</p> <p><b>Ref.: RM-2385**</b></p>	148'00€
 myonic	 <p>Synea® Vision TK-100</p> <p><b>Ref.: RM-2320</b></p>	<p>Tapa Ref.: TT-0654 Llave Ref.: HE-619</p> <p>158'00€</p>

## Rotores compatibles turbinas NSK®

RUMAR







	Modelos para NSK®	Relacionados
 myonic	 <p>CH-QD M NL-65 M</p> <p><b>Ref.: RM-0001</b> (Ref. NSK: NCH-MU03)</p>	148'00€
 myonic	 <p>CH-QD S NL-65 S Ti-MAX A450*</p> <p>Ti-MAX A450 Ti-MAX A450*L Ti-MAX A450L</p> <p><b>Ref.: RM-0002</b> (Ref. NSK: NCH-SU03)</p>	<p>Llave Doble Ref.: HE-600 Tapa Ref.: TT-0660</p> <p>* "K", "S", "W" y "B" indican sistema de acople de la turbina. Mismo rotor para todos.</p> <p>148'00€</p>

**GARANTÍA** de 12 meses sobre la pinza

**SI NO ENCUENTRAS EL REPUESTO QUE BUSCAS, ¡CONSÚLTANOS!**

**Precios:** impuestos, portes y mano de obra no incluidos.





















RUMAR

Modelos para NSK®		Relacionados
 myonic	 <p>CH-QD T NL-65 T Ti-MAX A455*</p> <p>Ti-MAX A455 Ti-MAX A455*L Ti-MAX A455L</p> <p><b>Ref.: RM-0003</b> (Ref. NSK: NCH-TU03)</p>	<p><b>Tapa Ref.:</b> TT-0661</p> <p>* "K", "S", "W" y "B" indican <b>sistema de acople</b> de la turbina. Mismo rotor para todos.</p> <p><b>148'00€</b></p>
 myonic	 <p>Ti-MAX A200* Ti-MAX A200 Ti-MAX A200*L</p> <p>Ti-MAX A200L Mach-Lite XT M</p> <p><b>Ref.: RM-0004</b> (Ref. NSK: NMC-MU03)</p>	<p>* "K", "S", "W" y "B" indican <b>sistema de acople</b> de la turbina. Mismo rotor para todos.</p> <p><b>148'00€</b></p>
 myonic	 <p>Ti-MAX A300* Ti-MAX A300 Ti-MAX A300*L</p> <p>Ti-MAX A300L Mach-Lite XTS</p> <p><b>Ref.: RM-0005</b> (Ref. NSK: NMC-SU03)</p>	<p><b>Llave Doble Ref.:</b> HE-600</p> <p>* "K", "S", "W" y "B" indican <b>sistema de acople</b> de la turbina. Mismo rotor para todos.</p> <p><b>148'00€</b></p>
 myonic	 <p>Ti-MAX A500* Ti-MAX A500*L Ti-MAX NL95M*</p> <p>Ti-MAX A500 Ti-MAX A500L Ti-MAX NL95M</p> <p><b>Ref.: RM-0007</b> (Ref. NSK: Ti-MU03)</p>	<p><b>Llave Ref.:</b> HE-107</p> <p>* "K", "S", "W" y "B" indican <b>sistema de acople</b> de la turbina. Mismo rotor para todos.</p> <p><b>148'00€</b></p>
 myonic	 <p>Ti-MAX A600* Ti-MAX A600*L Ti-MAX NL95S*</p> <p>Ti-MAX A600 Ti-MAX A600L Ti-MAX NL95S</p> <p>Ti-MAX NL45S Mach-Lite 2S</p> <p><b>Ref.: RM-0008</b> (Ref. NSK: Ti-SU03)</p>	<p><b>Llave Doble Ref.:</b> HE-600</p> <p>* "K", "S", "W" y "B" indican <b>sistema de acople</b> de la turbina. Mismo rotor para todos.</p> <p><b>148'00€</b></p>
 myonic	 <p>Ti-MAX A700* Ti-MAX A700*L Ti-MAX NL95T*</p> <p>Ti-MAX A700 Ti-MAX A700L Ti-MAX NL95T</p> <p>Ti-MAX NL45T Ti-MAX A400* Ti-MAX A400*L</p> <p>Ti-MAX A400 Ti-MAX A400L Mach-Lite XTT</p> <p>Mach-Lite 2T</p> <p><b>Ref.: RM-0009</b> (Ref. NSK: Ti-TU03, NMC-TU03)</p>	<p><b>Tapa Ref.:</b> TT-0230 <b>Llave Doble Ref.:</b> HE-600</p> <p>* "K", "S", "W" y "B" indican <b>sistema de acople</b> de la turbina. Mismo rotor para todos.</p> <p><b>148'00€</b></p>
 myonic	 <p>Ti-MAX X500* Ti-MAX X500*L NL9000M*</p> <p>Ti-MAX X500 Ti-MAX X500L NL9000M</p> <p><b>Ref.: RM-0010</b> (Ref. NSK: TiX-MU03)</p>	<p><b>Tapa Ref.:</b> TT-0223 <b>Llave Doble Ref.:</b> HE-605</p> <p>* "K", "S", "W" y "B" indican <b>sistema de acople</b> de la turbina. Mismo rotor para todos.</p> <p><b>148'00€</b></p>
 myonic	 <p>Ti-MAX X600* Ti-MAX X600*L NL9000S*</p> <p>Ti-MAX X600 Ti-MAX X600L NL9000S</p> <p>Ti-MAX X650* Ti-MAX X650*L Ti-MAX X650</p> <p>Ti-MAX X650L</p> <p><b>Ref.: RM-0011</b> (Ref. NSK: TiX- SU03)</p>	<p><b>Tapa Ref.:</b> TT-0224 <b>Llave Doble Ref.:</b> HE-600</p> <p>* "K", "S", "W" y "B" indican <b>sistema de acople</b> de la turbina. Mismo rotor para todos.</p> <p><b>148'00€</b></p>
 myonic	 <p>Ti-MAX X700* Ti-MAX X700*L NL9000*L</p> <p>Ti-MAX X700 Ti-MAX X700L NL9000L</p> <p><b>Ref.: RM-0012</b> (Ref. NSK: TiX-TU03)</p>	<p><b>Tapa Ref.:</b> TT-0225 <b>Llave Doble Ref.:</b> HE-605</p> <p>* "K", "S", "W" y "B" indican <b>sistema de acople</b> de la turbina. Mismo rotor para todos.</p> <p><b>148'00€</b></p>
 myonic	 <p>Pana Air Σ T</p> <p><b>Ref.: RM-0013</b> (Ref. NSK: NPA-TU03)</p>	<p><b>128'00€</b></p>

**GARANTÍA** de 12 meses sobre la pinza

**SI NO ENCUENTRAS EL REPUESTO QUE BUSCAS, ¡CONSÚLTANOS!**

**Precios:** impuestos, portes y mano de obra no incluidos.

	Modelos para NSK®				Relacionados
 myonic	 S-Max M500* S-Max M500*L S-Max M500	S-Max M500L Pana-Max Plus M S-Max M800*	S-Max M800*L S-Max M800 S-Max M800L		<b>Tapa Ref.:</b> TT-0226  * "K", "S", "W" y "B" indican sistema de acople de la turbina. Mismo rotor para todos.
 myonic	 Ti-MAX Z800* Ti-MAX Z800*L Ti-MAX Z800	Ti-MAX Z800L			<b>Tapa Ref.:</b> TT-8905 <b>Llave Doble Ref.:</b> HE-614  * "K", "S", "W" y "B" indican sistema de acople de la turbina. Mismo rotor para todos.
 myonic	 Ti-MAX Z900* Ti-MAX Z900*L Ti-MAX Z900	Ti-MAX Z900L			<b>Tapa Ref.:</b> TT-8904 <b>Llave Doble Ref.:</b> HE-614  * "K", "S", "W" y "B" indican sistema de acople de la turbina. Mismo rotor para todos.
 myonic	 S-Max Pico				<b>Llave Doble Ref.:</b> HE-632
 myonic	 Pana-Max T QD T Pana-Max TUM4				
 myonic	 Pana-Max S QD S Pana-Max SUM4				
 myonic	 Pana-Max 2				<b>Tapa Ref.:</b> TT-0232 <b>Llave Doble Ref.:</b> HE-600
 myonic	 Pana Air Σ S ECO TOPtorque				
 myonic	 S-Max M600* S-Max M600*L S-Max M900*	S-Max M900*L S-Max M600 S-Max M600L	S-Max M900 S-Max M900L Pana-Max Plus S	PAP-SUM4	<b>Tapa Ref.:</b> TT-0227 <b>Llave Doble Ref.:</b> HE-632  * "K", "S", "W" y "B" indican sistema de acople de la turbina. Mismo rotor para todos.
 myonic	 Ti-MAX Z890				<b>Tapa Ref.:</b> TT-0658

**GARANTÍA** de 12 meses sobre la pínza

**SI NO ENCUENTRAS EL REPUESTO QUE BUSCAS, ¡CONSÚLTANOS!**

**Precios:** impuestos, portes y mano de obra no incluidos.

## Modelos para NSK®

## Relacionados



myonic

TI-MAX Z990

Ref.: **RM-0025** (Ref. NSK®: TIZ9-SU03 / PA2381X001)158<sup>00</sup>€

Tapa Ref.: TT-0659

## Rotores compatibles turbinas Morita®

RUMAR

## Modelos para Morita®

## Relacionados



myonic

TwinPower **PAR-4HUEX-O**Ref.: **RM-2601** (Ref. Morita®: PAR-4HUEX-O)148<sup>00</sup>€

Tapa Ref.: TT-0662



myonic

\*Ver nota

TwinPower **PAR-4HX-O\***Ref.: **RM-2602** (Ref. Morita®: PAR-4HX-O)148<sup>00</sup>€

\* Rotor se suministra SIN cartucho. Se debe reutilizar el cartucho original.

Tapa Ref.: TT-0663  
Llave Ref.: HE-638

myonic

\*Ver nota

TwinPower **PAR-4HEX-O\***Ref.: **RM-2603** (Ref. Morita®: PAR-4HEX-O)148<sup>00</sup>€

\* Rotor se suministra SIN cartucho. Se debe reutilizar el cartucho original.

Llave Ref.: HE-637

## Rotores compatibles turbinas Castellini®, Anthos®

RUMAR

## Modelos para Castellini® / Anthos®

## Relacionados



myonic

Hi Power M  
Cleanlight  
CleanairRef.: **RM-2506** (Ref. Castellini: L0000874)148<sup>00</sup>€Tapa Ref.: TT-0801  
Llave Ref.: HE-824 (Llave tapa TT-0801)  
Llave Ref.: HE-800 (Llave para tapa original)

myonic

Titanium Gold 2  
Hi Power Light  
GoldHi Power 2  
Hi Power CeramicRef.: **RM-2516** (Ref. Castellini®: L0001370)148<sup>00</sup>€Tapa Ref.: TT-0811  
Llave Ref.: HE-810







myonic

Silent Power **Gold**  
Silent Power **Gold** M  
Silent Power **Silver** 2Silent Power **Silver** 2L  
Silent Power **Silver** 4L  
Silent Power **Silver** 4LKRef.: **RM-2528** (Ref. Castellini®: L0001857)148<sup>00</sup>€Tapa Ref.: TT-0827  
Llave Ref.: HE-824

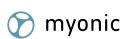
myonic

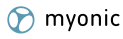

Silent Power **EVO** 2  
Silent Power **EVO** 2L  
Silent Power **EVO** 4LSilent Power **EVO** 4LKRef.: **RM-2518**148<sup>00</sup>€Tapa Ref.: TT-0825  
Llave Ref.: HE-822

**Rotores compatibles turbinas FONA®** RUMAR





Modelos para FONA®		Relacionados
	 <p>6080MR (Standard) 8060SR (Standard)</p> <p><b>Ref.: RM-2256</b></p> <p><b>148'00€</b></p>	Tapa Ref.: TT-8897
	 <p>6080MM (Mini) 8080SM (Mini)</p> <p><b>Ref.: RM-2261</b></p> <p><b>148'00€</b></p>	
	 <p>8080SR (Standard)</p> <p><b>Ref.: RM-2262</b></p> <p><b>148'00€</b></p>	

**Rotores turbinas Woodpecker® / DTE®** 

NUEVO

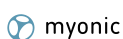

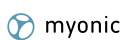

Modelos para Woodpecker® / DTE®		Relacionados
	 <p>HP33 (Todos los modelos)</p> <p><b>Ref.: 28-T001</b></p> <p><b>64'80€</b></p>	

**Rotores compatibles turbinas B.A. International®** RUMAR



Modelos para B.A. International®		Relacionados
	 <p>B.A. Ultimate 670 B.A. Ultimate 650</p> <p><b>Ref.: RM-2106</b></p> <p><b>148'00€</b></p>	
	 <p>B.A. Ultimate 535 B.A. Ultimate 685</p> <p>B.A. Ultimate 695 <b>(Confirmar con imagen)</b></p> <p><b>Ref.: RM-2256</b></p> <p><b>148'00€</b></p>	
	 <p>B.A. Ultimate 755</p> <p><b>Ref.: RM-2262</b></p> <p><b>148'00€</b></p>	
	 <p>B.A. Ultimate 695 <b>(Confirmar con imagen)</b></p> <p><b>Ref.: RM-2266</b></p> <p><b>148'00€</b></p>	

**GARANTÍA** de 12 meses sobre la pinza  
**SI NO ENCUENTRAS EL REPUESTO QUE BUSCAS, ¡CONSÚLTANOS!**  
**Precios:** impuestos, portes y mano de obra no incluidos.

Rotores compatibles turbinas FARO®

Modelos para FARO®		Relacionados	
 myonic	 MT02 Standard MT02L Standard Ref.: <b>RM-2176</b>	Tapa Ref.: TT-2076 Llave Doble Ref.: HE-604 148'00€	
 myonic	 MT02 Mini MT02L Mini Ref.: <b>RM-2115</b>	Tapa Ref.: TT-7051 Llave Doble Ref.: HE-604 148'00€	

Rotores compatibles turbinas CHIRANA®

Modelos para CHIRANA®		Relacionados	
 myonic	 TC 656 TGL 637A (smile - music) Ref.: <b>RM-2106</b>	Tapa Ref.: TT-4041 Llave Ref.: HE-609 148'00€	

Rotores compatibles turbinas R-Tech®

- Rodamientos cerámicos.
- Con anillos tóricos, arandelas metálicas y anillos de teflón según modelo.
- **Garantía:** 6 meses sobre la pinza

Modelos para R-Tech®		Relacionados	
 myonic	 PowerMax Ref.: <b>RM-0401</b>	Tapa Ref.: TT-0415 98'00€	HASTA AGOTAR
 myonic	 ECO T2 ECO T3 LED PRO T1 L Ref.: <b>RM-0250R</b>	Tapa Ref.: TT-0250T Llave Ref.: HE-252K 64'80€	
 myonic	 ECO T TURBO COXO TITAN Ref.: <b>RM-0253R</b>	Tapa Ref.: TT-0253T Llave Ref.: HE-253K 78'00€	

**GARANTÍA** de 12 meses sobre la pinza

**Modelo para LARES®**

**Relacionados**



myonic

757\*  
757 Prostyle\*  
con Multi spray con rods. myonic

Ref.: **RM-2536**

**148<sup>00</sup>€**

\*Confirmar con imagen

Las turbinas con un solo orificio de spray llevan otro rotor.

## ROTORES TURBINAS LABORATORIO

### Rotores compatibles turbinas laboratorio KaVo®

RUMAR

Modelos para KaVo®		Relacionados	
 Imagen no disponible myonic	743 744  <b>Ref.: RM-2101</b> (Ref. KaVo®: 0.553.6031)	<b>188'00€</b>	<b>BAJO PEDIDO</b>
 Imagen no disponible myonic	737  <b>Ref.: RM-2102</b> (Ref. KaVo®: 0.553.6141)	<b>188'00€</b>	<b>BAJO PEDIDO</b>



### Rotores compatibles turbinas laboratorio Bien Air®

RUMAR

Modelos para Bien Air®		Relacionados	
 myonic	Serie TD (Todos los modelos)  <b>Ref.: RM-2496</b>	<b>198'00€</b>	

### Rotores compatibles turbinas laboratorio NSK®

RUMAR

Modelos para NSK®		Relacionados	
 myonic	Presto  <b>Ref.: RM-0080</b> (Ref. NSK: T815-016)	<b>188'00€</b>	
 myonic	Presto AQUA (Excepto LUX)  <b>Ref.: RM-0081</b> (Ref. NSK: T816-016)	<b>188'00€</b>	

### Rotores turbinas MK-dent® (CON INSERTOS DE CARBURO)







Modelos para MK-dent®			Relacionados
 myonic	HB11* HB12* HB21K*	HC2021 desde serie F HC4021 (comprobar imagen) HC6021 hasta serie E HC2002	HE11* HE12* HE15L*
<b>Ref.: TR-TC2021</b>		<b>189'00€</b>	*Tapa Ref.: TT-BC1034 Llave Ref.: HE-620, HE-1650T

GARANTÍA de 12 meses sobre la pinza

## Modelos para MK-dent®









## Relacionados

	HC4011** HC4021 (comprobar imagen)* HC6021 desde serie F*	HC7031** HC7021* HC5031**	HC5021* HC2022**	<b>Según modelo:</b> <b>*Tapa Ref.:</b> TT-BC2021K <b>**Tapa Ref.:</b> TT-BC2031 (Descatalogado) <b>Llave Ref.:</b> HE-620
<b>Ref.:</b> TR-TC2031				<b>189'00.€</b>
	HB14* HB23* HE14*	HC4012 HC6012 HC5022	HC4022 HC7022 HC6022 desde serie F	<b>*Tapa Ref.:</b> TT-BC1035 <b>Llave Ref.:</b> HE-620, HE-1650T
<b>Ref.:</b> TR-TC2032				<b>189'00.€</b>
	HE17 (HE010000 < N/S < HE023799) HE21K HE21KL HE21N	HE21NL HE21S HE21SL HE21W	HE21WL HB21	<b>Tapa Ref.:</b> TT-BC1034 <b>Llave Ref.:</b> HE-620, HE-1650T
<b>Ref.:</b> TR-TC2034				<b>189'00.€</b>
	HE14 HE18 HE22K HE22KL	HE22N HE22NL HE22S	HE22SL HE22W HE22WL	<b>Tapa Ref.:</b> TT-BC1035 <b>Llave Ref.:</b> HE-620
<b>Ref.:</b> TR-TC2035				<b>189'00.€</b>
	HC20K HC20KL HE20k HE20kl	HC21K HC21KL HC21N HC21NL	HC21S HC21SL HC21W HC21WL	
<b>Ref.:</b> TR-TC2038				<b>189'00.€</b>
	HC22K HC22KL HC22N	HC22NL HC22S HC22SL	HC22W HC22WL	<b>Tapa Ref.:</b> TT-BC1042 <b>Llave Ref.:</b> HE-620
<b>Ref.:</b> TR-TC2039				<b>189'00.€</b>
	HC8021 HC9021 HP21K HP21KL	HP21S HP21SL HP21N	HP21NL HP21W HP21WL	<b>Tapa Ref.:</b> TT-BC1051 <b>Llave Ref.:</b> HE-1651T
<b>Ref.:</b> TR-TC2041				<b>189'00.€</b>
	HC8022 HC9022 HP22K HP22KL	HP22S HP22SL HP22N	HP22NL HP22W HP22WL	<b>Tapa Ref.:</b> TT-BC1042 <b>Llave Ref.:</b> HE-620
<b>Ref.:</b> TR-TC2042				<b>189'00.€</b>
	HE17 (N/S > HE023800)			<b>Tapa Ref.:</b> TT-BC1046 <b>Llave Ref.:</b> HE-1651T
<b>Ref.:</b> TR-TC2046				<b>189'00.€</b>

# TAPAS TURBINA

Tapas compatibles turbinas KaVo®





RUMAR

	Modelos para KaVo®	Relacionados
	SMARTtorque® S605 SMARTtorque® S615C EXPERTtorque® E677  <b>Ref.: TT-7051</b> (Ref. KaVo®: 1.007.7051 / 3.001.5378 / 3.001.8670)	MASTERtorque® Mini Lux M8700L EXPERTtorque® Mini Lux E675L  <b>28'00€</b>  Llave Doble Ref.: HE-604
	624 625 625C  <b>Ref.: TT-4041</b> (Ref. KaVo®: 0.553.4041)	625D 627 630  630A  <b>54'80€</b>  Llave Ref.: HE-609
	MIRAlux® 635 MIRAtorque mini® 637  <b>Ref.: TT-8491</b> (Ref. KaVo®: 0.553.8491)	Llave Ref.: HE-1637T  <b>28'00€</b>
	SUPERtorque® 647 SUPERtorque® 650 COMPACTtorque® 636  <b>Ref.: TT-8061</b> (Ref. KaVo®: 0.553.8061)	POWERtorque® 646  Llave Doble Ref.: HE-604  <b>28'00€</b>
	CONTACTair® 632 CONTACTair® 633  <b>Ref.: TT-5081</b> (Ref. KaVo®: 0.553.5081)	BELLAtorque® 639 BELLAtorque® 642  Llave Ref.: HE-609  <b>28'00€</b>
	BELLAtorque® 645  <b>Ref.: TT-7391</b> (Ref. KaVo®: 0.553.7391)	Llave Ref.: HE-609  <b>28'00€</b>
	SUPERtorque® 640  <b>Ref.: TT-6511</b> (Ref. KaVo®: 0.553.6511)	Llave Ref.: HE-609  <b>28'00€</b>
	SMARTtorque® S609 SMARTtorque® S619 SUPERtorque® 655 SUPERtorque® 660  <b>Ref.: TT-2076</b> (Ref. KaVo®: 1.000.2076 / 1.000.4770)	GENTLEforce® 6000 GENTLEforce® 7000  Llave Doble Ref.: HE-604  <b>28'00€</b>
	GENTLEsilence mini® 4500B GENTLEsilence mini® 4500C GENTLEsilence mini® 5000B  <b>Ref.: TT-1079</b> (Ref. KaVo®: 1.006.1079)	GENTLEsilence mini® 5000C  Llave Doble Ref.: HE-604  <b>28'00€</b>

Modelos para KaVo®		Relacionados
	CENTLEsilence® 8000 MASTERtorque® M9000L  <b>Ref.: TT-5525</b> (Ref. KaVo®: 1.003.5525 / 3.000.1874)	Llave Doble Ref.: HE-604  <b>28'00€</b>
	EXPERTtorque® E679L EXPERTtorque® E680L  <b>Ref.: TT-8903</b> (Ref. KaVo®: 1.007.8903)	Llave Doble Ref.: HE-604  <b>28'00€</b>
 <small>Imagen no disponible</small>	MASTERtorque mini® M8900L  <b>Ref.: TT-8900</b>	<b>56'80€</b>  <b>BAJO PEDIDO</b>
 <small>Imagen no disponible</small>	MASTERtorque mini® M8700L  <b>Ref.: TT-8700</b>	<b>56'80€</b>  <b>BAJO PEDIDO</b>

▶ Tapas compatibles turbinas **Bien Air®**



RUMAR

Modelos para Bien Air®		Relacionados
 <b>3 piezas</b>	Bora S36-L Rotamax L (3 piezas)  <b>Ref.: TT-2468</b>	Llave Doble Ref.: HE-802  <b>34'80€</b>
 <b>1 pieza, NO separable</b>	Bora S36-L Rotamax L  <b>Ref.: TT-2469</b>	Llave Doble Ref.: HE-802  <b>54'80€</b>
	Bora 2  <b>Ref.: TT-2999</b> (Ref. Bien Air® 150.2999)	Llave Ref.: HE-618  <b>56'80€</b>
 <b>3 piezas</b>	Croma Black Pearl Boralina  Eolia S25-L  <b>Ref.: TT-2459</b>	Llave Doble Ref.: HE-802  <b>34'80€</b>
	Prestige  <b>Ref.: TT-0651</b>	Llave Ref.: HE-803  <b>54'80€</b>

**SI NO ENCUENTRAS EL REPUESTO QUE BUSCAS, ¡CONSÚLTANOS!**  
Precios: impuestos, portes y mano de obra no incluidos.

## Modelos para Bien Air®

## Relacionados







 <small>Imagen no disponible</small>	<p>Ondine</p> <p><b>Ref.: TT-2467</b> <span style="float: right;"><b>54'80€</b></span></p>	<p>Llave Ref.: HE-803</p>
	<p>Tornado</p> <p><b>Ref.: TT-1835</b> (Ref. Bien Air® 1501835) <span style="float: right;"><b>54'80€</b></span></p>	<p>Llave Ref.: HE-831</p>
	<p>Tornado S (cabeza mini)</p> <p><b>Ref.: TT-1963</b> (Ref. Bien Air® 1501963) <span style="float: right;"><b>54'80€</b></span></p>	<p>Llave Ref.: HE-846</p>











## Tapas compatibles turbinas Siemens® / Sirona®

RUMAR

## Modelos para Siemens® / Sirona®





## Relacionados

	<p>TM1 4000ML 4000S          TS1 4000M Siemens T1 Control          TS2 4000SL</p> <p><b>Ref.: TT-4000</b> <span style="float: right;"><b>56'80€</b></span></p>	
	<p>T1 Control (Exterior. Con rebaje) (N/S&lt;65.000)          TC3 Control (N/S&lt;65.000)</p> <p><b>Ref.: TT-7595</b> (Ref. Sirona®: 3327595 / 5828871 / 6000900) <span style="float: right;"><b>32'80€</b></span></p>	<p>Llave Ref.: HE-592</p>
	<p>T1 Control (sin rebaje) (502.000&lt;N/S&lt;600.000)          T2 Control (N/S&lt;600.000)          SiroPure P Control</p> <p><b>Ref.: TT-0884</b> (Ref. Sirona®: 6000884) <span style="float: right;"><b>32'80€</b></span></p>	<p>Llave Ref.: HE-591</p>
	<p>T1 Control (N/S&gt;600.000)          T2 Control (N/S&gt;600.000)</p> <p><b>Ref.: TT-5798</b> (Ref. Sirona®: 6465798) <span style="float: right;"><b>56'80€</b></span></p>	<p>Llave Ref.: HE-633</p>
	<p>T1 Control (N/S&gt;700.000)          T2 Control (N/S&gt;700.000)</p> <p><b>Ref.: TT-8184</b> (Ref. Sirona®: 6548148) <span style="float: right;"><b>56'80€</b></span></p>	<p>Llave Ref.: HE-633</p>
	<p>T1 Control (N/S&gt;800.000)          T2 Control (N/S&gt;800.000)</p> <p><b>Ref.: TT-5704</b> (Ref. Sirona®: 6725704) <span style="float: right;"><b>56'80€</b></span></p>	<p>Llave Ref.: HE-636</p>

Modelos para Siemens® / Sirona®		Relacionados
	T2 Racer T3 Racer (N/S<600.000) T4 Racer (N/S<600.000)  <b>Ref.: TT-8897</b> (Ref. Sirona®: 6000892)	Llave Ref.: HE-591  <b>32<sup>80</sup>€</b>
	T3 Racer (N/S>600.000) T4 Racer (N/S>600.000)  <b>Ref.: TT-0212</b> (Ref. Sirona®: 6486125)	Llave Ref.: HE-612  <b>32<sup>80</sup>€</b>
	T3 Racer (N/S>800.000) T4 Racer (N/S>800.000)  <b>Ref.: TT-6744</b> (Ref. Sirona®: 6726744)	<b>56<sup>80</sup>€</b>
	SiroBoost  <b>Ref.: TT-1439</b> (Ref. Sirona®: 6401439)	Llave Ref.: HE-591  <b>56<sup>80</sup>€</b>
	T1 Mini (N/S<600.000)      SiroPure P mini T2 Mini (N/S<600.000) T3 Mini (N/S<600.000)  <b>Ref.: TT-8871</b> (Ref. Sirona®: 5828871)	Llave Ref.: HE-591  <b>56<sup>80</sup>€</b>
	T1 mini (600.000<N/S<700.000) T2 mini (600.000<N/S<700.000) T3 mini (600.000<N/S<700.000)  <b>Ref.: TT-0213</b> (Ref. Sirona®: 64658814)	Llave Ref.: HE-592  <b>32<sup>80</sup>€</b>
 <small>Imagen no disponible</small>	T1 Mini (700.00<N/S<800.000) T2 Mini (700.00<N/S<800.000) T3 Mini (700.00<N/S<800.000)  <b>Ref.: TT-8163</b> (Ref. Sirona®: 6548163)	Llave Ref.: HE-634  <b>56<sup>80</sup>€</b> <span style="background-color: green; color: white; padding: 2px;">BAJO PEDIDO</span>
	T1 Mini (N/S>800.000) T2 Mini (N/S>800.000) T3 Mini (N/S>800.000)  <b>Ref.: TT-5720</b> (Ref. Sirona®: 6725720)	Llave Ref.: HE-635  <b>56<sup>80</sup>€</b>
	T1 mini TMC 1L (N/S<65.000) T1 mini TMC 3L (N/S<65.000)  <b>Ref.: TT-8575</b> (Ref. Sirona®: 4178575)	Incluye arandela  <b>32<sup>80</sup>€</b>
	T3 Racer mini (N/S>600.000)  <b>Ref.: TT-9172</b> (Ref. Sirona®: 6449172)	<b>56<sup>80</sup>€</b> <span style="background-color: green; color: white; padding: 2px;">BAJO PEDIDO</span>

## Modelos para Siemens® / Sirona®

## Relacionados





	T3 Racer mini (N/S>800.000)		
	<b>Ref.: TT-6751</b> (Ref. Sirona®: 6726751)	<b>56<sup>80</sup>€</b>	<b>BAJO PEDIDO</b>
	T1 Boost (N/S>600.000) T2 Boost (N/S>600.000) T3 Boost (N/S>600.000)		Llave Ref.: HE-612
	<b>Ref.: TT-0814</b> (Ref. Sirona®: 6465806)	<b>32<sup>80</sup>€</b>	
	T1 Boost (N/S>700.000) T2 Boost (N/S>700.000) T3 Boost (N/S>700.000)		Llave Ref.: HE-612
	<b>Ref.: TT-0836</b> (Ref. Sirona®: 6548155)	<b>56<sup>80</sup>€</b>	
	T1 Boost (N/S>800.000) T2 Boost (N/S>800.000) T3 Boost (N/S>800.000)		Llave Ref.: HE-617
	<b>Ref.: TT-5712</b> (Ref. Sirona®: 6725712)	<b>56<sup>80</sup>€</b>	







## Tapas compatibles turbinas W&amp;H®

RUMAR

## Modelos para W&amp;H®



## Relacionados











	Top Air 398 Top Air 698 Top Air 795 Top Air 798 Top Air 895	Top Air 898 Trend TC 80BC Trend TC-95BC Alegra® TE-98 Alegra® TE-95 (hasta 2009)	
	<b>Ref.: TT-4165</b> (Ref. W&H®: 04232400)	<b>32<sup>80</sup>€</b>	Llave Ref.: HE-606
	Alegra® TE-95 Alegra® TE-98 Alegra® TE-98 C LED (desde 2009)		Llave Ref.: HE-606
	<b>Ref.: TT-9800</b> (Ref. W&H®: 05489800)	<b>56<sup>80</sup>€</b>	
	Alegra® TE-95 Alegra® TE-98 (hasta 2009)		
	<b>Ref.: TT-9802</b>	<b>56<sup>80</sup>€</b>	
	Alegra® HS2014 TE-95 Alegra® HS2014 TE-98		Llave Ref.: HE-829
	<b>Ref.: TT-0656</b>	<b>56<sup>80</sup>€</b>	
	Alegra® HS2014 TE-97		Llave Ref.: HE-610, HE-829
	<b>Ref.: TT-0657</b>	<b>56<sup>80</sup>€</b>	

Modelos para W&H®		Relacionados
	<p><b>3 muescas</b></p> <p>Synea® TA-98C LED                      Synea® TA-98 (desde 2007)                      Synea® Vision TK-98</p> <p>Fusion TG-98</p> <p><b>Ref.: TT-4166</b> (Ref. W&amp;H®: 06446300)</p>	<p>Llave Doble Ref.: HE-602</p> <p><b>32´80€</b></p>
	<p><b>3 muescas</b></p> <p>Synea® TA-97C LED                      Synea® TA-97 (desde 2007)</p> <p><b>Ref.: TT-3300</b> (Ref. W&amp;H®: 05183300)</p>	<p>Llave Doble Ref.: HE-602</p> <p><b>56´80€</b></p>
	<p><b>2 muescas</b></p> <p>Synea® TA-98 (hasta 2009)</p> <p><b>Ref.: TT-4168</b> (Ref. W&amp;H®: 03503000)</p>	<p>Llave Ref.: HE-840</p> <p><b>29´80€</b></p>
	<p>Synea® TA-96 (hasta 2009)</p> <p><b>Ref.: TT-0096</b></p>	<p><b>56´80€</b></p> <p>BAJO PEDIDO</p>
	<p>Synea® Vision TK-95</p> <p><b>Ref.: TT-0655</b></p>	<p><b>56´80€</b></p> <p>BAJO PEDIDO</p>
	<p>Synea® Vision TK-98</p> <p><b>Ref.: TT-0653</b></p>	<p><b>56´80€</b></p>

▶ Tapas compatibles turbinas **NSK®**

RUMAR

Modelos para NSK®		Relacionados
	<p>Synea® Vision TK-100</p> <p><b>Ref.: TT-0654</b></p>	<p>Llave Doble Ref.: HE-619</p> <p><b>56´80€</b></p>
	<p>TI-MAX X500                      TI-MAX X500L</p> <p><b>Ref.: TT-0223</b></p>	<p>Llave Doble Ref.: HE-605</p> <p><b>29´80€</b></p>
	<p>TI-MAX X600                      TI-MAX X600L</p> <p><b>Ref.: TT-0224</b></p>	<p>Llave Doble Ref.: HE-600</p> <p><b>29´80€</b></p>

Modelos para NSK®		Relacionados
	TI-MAX X700 TI-MAX X700L  <b>Ref.: TT-0225</b>	Llave Doble Ref.: HE-605  <b>29<sup>80</sup>€</b>
	TI-MAX Z900 TI-MAX Z900L  <b>Ref.: TT-8904</b>	Llave Doble Ref.: HE-614  <b>29<sup>80</sup>€</b>
	TI-MAX Z800 TI-MAX Z800L  <b>Ref.: TT-8905</b>	Llave Doble Ref.: HE-614  <b>29<sup>80</sup>€</b>
	S-MAX M500 S-MAX M500L  <b>Ref.: TT-0226</b>	  <b>29<sup>80</sup>€</b>
	S-MAX M600 S-MAX M600L  <b>Ref.: TT-0227</b>	S-MAX M900 S-MAX M900L  Llave Doble Ref.: HE-632  <b>29<sup>80</sup>€</b>
	TI-MAX A300 TI-MAX A300L MACH LITE S  <b>Ref.: TT-0228</b>	MACH LITE XT S MACH QD-S MACH 2 S  Llave Doble Ref.: HE-600  <b>56<sup>80</sup>€</b>
	TI-MAX A600 TI-MAX A600L TI-MAX NL95  <b>Ref.: TT-0229</b>	TI-MAX NL95 S TI-MAX NL45 S  Llave Doble Ref.: HE-600  <b>56<sup>80</sup>€</b>
	TI-MAX A400 TI-MAX A400L MACH LITE XT T  <b>Ref.: TT-0230</b>	MACH QD-T MACH LITE T MACH 2 T  <b>56<sup>80</sup>€</b>
	TI-MAX A700 TI-MAX A700L TI-MAX NL95 T  <b>Ref.: TT-0231</b>	TI-MAX NL45 T  Llave Doble Ref.: HE-600  <b>56<sup>80</sup>€</b>
	Pana-Max 2  <b>Ref.: TT-0232</b>	  <b>28<sup>00</sup>€</b>

### Modelos para NSK®

### Relacionados

NUEVO



Ti-MAX Z890L  
Ti-MAX Z890\*L

Ref.: **TT-0658** (Ref. NSK®: PA2380X050)

56<sup>80</sup>€

\* "K", "S", "W" y "B" indican sistema de acople de la turbina. Mismo rotor para todos.

NUEVO



Ti-MAX Z990L  
Ti-MAX Z990\*L

Ref.: **TT-0659** (Ref. NSK®: PA2381X050)

56<sup>80</sup>€

\* "K", "S", "W" y "B" indican sistema de acople de la turbina. Mismo rotor para todos.

NUEVO



Ti-MAX A450  
Ti-MAX A450\*  
Ti-MAX A450L

Ti-MAX A450\*L  
Phatelus 45S  
MACH LITE 65S

MACH QD 45

Ref.: **TT-0660** (Ref. NSK®: NCH-SU04)

56<sup>80</sup>€

\* "K", "S", "W" y "B" indican sistema de acople de la turbina. Mismo rotor para todos.

NUEVO



Ti-MAX A455  
Ti-MAX A455\*  
Ti-MAX A455L

Ti-MAX A455\*L  
Phatelus 45 TORQUE  
Phatelus 65T

Ref.: **TT-0661** (Ref. NSK®: NCH-TU04 / P042050)

56<sup>80</sup>€

\* "K", "S", "W" y "B" indican sistema de acople de la turbina. Mismo rotor para todos.

### Tapas compatibles turbinas Morita®

RUMAR

### Modelos para Morita®

### Relacionados

NUEVO



Twin Power **PAR-4HUEX-O**  
Twin Power **PAR-4HUMX-O**

Ref.: **TT-0662**

56<sup>80</sup>€

NUEVO



Twin Power **PAR-4HX-O**

Ref.: **TT-0663**

56<sup>80</sup>€

Llave Ref.: HE-638

### Tapas compatibles turbinas Woodpecker® / DTE®

WOODPECKER DTE®

### Modelos para Woodpecker® / DTE®

### Relacionados

NUEVO



Imagen no disponible

HP33 (Todos los modelos)

Ref.: **28-T002**





18<sup>00</sup>€

SI NO ENCUENTRAS EL REPUESTO QUE BUSCAS, ¡CONSÚLTANOS!  
Precios: impuestos, portes y mano de obra no incluidos.

RUMAR

Tapas compatibles turbinas **Castellini®**, **Anthos®**, **Stern Weber®** y **Cefla®**

RUMAR

	Modelos para Castellini®, Anthos®, Stern Weber® y Cefla®	Relacionados
	<p>Hi Power M Clean Air 2000 Clean Air 2000R</p> <p>Titanium Power Cleanlight 2000 Cleanlight 2000R</p> <p><b>Ref.: TT-0801</b> (Ref. Castellini®: F633F03RO)</p>	<p><b>Llave Ref.:</b> HE-824 (Llave para tapa TT-0801) <b>Llave Ref.:</b> HE-800 (Llave para tapa original (2 orificios))</p>
	<p>Silent Power Gold Silent Power Gold M</p> <p>Titanium Gold Titanium Gold 2</p> <p><b>Ref.: TT-0811</b> (Ref. Castellini®: F699F0RO)</p>	<b>Llave Ref.:</b> HE-810
	<p>Silent Power EVO 2 Silent Power EVO 2L</p> <p>Silent Power EVO 4L Silent Power EVO 4LK</p> <p><b>Ref.: TT-0825</b> (Ref. Fabricante: 95529229)</p>	<b>Llave Ref.:</b> HE-822
	<p>Silent Power EVO Miniature Silent Power EVO Miniature K</p> <p><b>Ref.: TT-0826</b> (Ref. Fabricante: 95529231)</p>	<b>Llave Ref.:</b> HE-823
	<p>Silent Power Silver 2 Silent Power Silver 2L</p> <p>Silent Power Silver 4L Silent Power Silver 4LK</p> <p><b>Ref.: TT-0827</b> (Ref. Castellini®: F699F40RD)</p>	<b>Llave Ref.:</b> HE-824

Tapas compatibles turbinas **Faro®**

RUMAR





	Modelos para Faro®	Relacionados
	<p>S400 S405</p> <p><b>Ref.: TT-2542</b></p>	<b>54'80€</b>

Tapas compatibles turbinas **CHIRANA®**

RUMAR

	Modelos para CHIRANA®	Relacionados
	<p>TG 656 TGL 637A (smile - music)</p> <p><b>Ref.: TT-4041</b></p>	<b>Llave Ref.:</b> HE-609



Tapas turbinas RUMAR®

Modelos para RUMAR®		Relacionados	
	PowerMax  <b>Ref.: TT-0415</b>	<b>48<sup>00</sup>€</b>	HASTA AGOTAR
	ECO T1 ECO TLED2  <b>Ref.: TT-0368</b>	<b>28<sup>00</sup>€</b>	HASTA AGOTAR
	ECO TLED1  <b>Ref.: TT-0341T</b>	<b>28<sup>00</sup>€</b>	HASTA AGOTAR
	ECO T2 ECO T3 LED PRO T1  <b>Ref.: TT-0250T</b>	<b>28<sup>00</sup>€</b>	Llave Ref.: HE-252K
	ECO TURBO COXO TITAN  <b>Ref.: TT-0253T</b>	<b>28<sup>00</sup>€</b>	Llave Ref.: HE-253K

Tapas turbinas MK-dent®



Modelos para MK-dent®		Relacionados	
	HC4021 HC5021  <b>Ref.: TT-BC2021K</b>	HC6021 a partir serie F HC7021 HE12	Llave Ref.: HE- 620  HASTA AGOTAR
 4 lados de contacto	HP21 HC21 HC20  <b>Ref.: TT-BC1051</b>	HC8021 HC9021  (antigua TT-BC2041 y 05-BC1041)	Llave Ref.: HE- 1651T (4 lados de contacto)  *Antiguas BC2041 y BC1041 necesitan llave KE1650T* (4 muescas de contacto)
	HP22 HP22 L  <b>Ref.: TT-BC1042</b>	HC22 HC22 L	Llave Ref.: HE-620
	HC8022 HC9022  <b>Ref.: TT-BC2042</b>		Llave Ref.: HE-620  HASTA AGOTAR

Modelos para MK-dent®		Relacionados
	4 muescas HE14 HE15 HE18  <b>Ref.: TT-BC1034</b>	HE17 (HE010000 < N/S < HE023799) HE21  <b>45'80€</b>  Llave Ref.: HE-620
	HE22 HE14 HE18  <b>Ref.: TT-BC1035</b>	   <b>45'80€</b>  Llave Ref.: HE-620
	4 lados de contacto HE17 (N/S > HE023800)  <b>Ref.: TT-BC1046</b>	   <b>45'80€</b>  Llave Ref.: HE-1651T

### ▶ Tapas compatibles turbinas TKD®

RUMAR

Modelos para TKD®		Relacionados
	Thera  <b>Ref.: TT-0421</b>	   <b>48'00€</b>

## TAPAS DE SPRAY TURBINA / DIFUSOR SPRAY

Tapas de spray / difusor spray compatibles turbinas **KaVo®**

RUMAR

	Modelos para KaVo®	Observaciones
	<p>SUPERtorque® 630 SUPERtorque® 640</p> <p><b>Ref.: TX-8752</b> (Ref. KaVo: 0.553.8752)</p>	<b>14'80.€</b>
	<p>SUPERtorque® 647</p> <p><b>Ref.: TX-0833</b> (Ref. KaVo: 0.553.0833)</p>	<b>16'80.€</b>
	<p>SUPERtorque® 650 SUPERtorque® 655 SUPERtorque® 660</p> <p><b>Ref.: TX-0573</b> (Ref. KaVo: 0.553.0573)</p>	<b>19'80.€</b> <b>Incluye:</b> 2 anillos tóricos. (Ref. KaVo 0.200.6175 y 0.200.6176)
 TX-0563	<p>Pin posicionamiento tapa spray modelos: SUPERtorque® 650 SUPERtorque® 655 SUPERtorque® 660 <b>***Original KaVo***</b></p> <p><b>Ref.: TX-0563</b> (Ref. KaVo: 0.553.0563 / 5)</p>	<b>2'80.€</b> <b>Incluye:</b> 1 unidad

Tapas de spray / difusor spray compatibles turbinas **RUMAR®**

RUMAR

	Modelos para RUMAR®	Observaciones
	<p>PowerMax</p> <p><b>Ref.: TX-0420</b></p>	<b>19'90.€</b> <b>Llave Ref.: HE-629</b> <b>HASTA AGOTAR</b>

▶ Tapas de spray / difusor spray turbinas **MK-dent®**

	Modelos para MK-dent®	Observaciones
	HC4021 HC5021 HC7021  <b>Ref.: TX-8752</b>	HC2022 HC6021 a partir serie G y otras triple spray  <b>14'80€</b>
	HC4022 HC5022 HC6022  <b>Ref.: TX-0833</b>	HC7022  <b>16'80€</b>
	Tobera de spray turbinas líneas: HE HC HP  <b>Ref.: TX-SP0641</b>	<b>48'00€</b>



## TORNILLOS DE TAPA DE SPRAY / DIFUSOR SPRAY

▶ Tornillos de tapa de spray / difusor spray compatibles turbina **KaVo®**

	Modelos para KaVo®	Observaciones
	SUPERtorque® 630 SUPERtorque® 640  <b>Ref.: TX-3322</b> (Ref. KaVo®: 0.553.3322)	Llave Ref.: HE-1022KT  <b>4'00€</b>
	SUPERtorque® 655 SUPERtorque® 660  <b>Ref.: TX-3391</b> (Ref. KaVo®: 1.000.3391)	Llave Ref.: HE-1022KT  <b>5'80€</b>
	SUPERtorque® 650 B SUPERtorque® 650 C  <b>Ref.: TX-0543</b> (Ref. KaVo®: 0.553.0543)	Llave Ref.: HE-621  <b>5'80€</b>

## Tornillos de tapa de spray turbina MK-dent®



RUMAR

	Modelos para MK-dent®	Observaciones
	HC4021 HC5021 HC7021  <b>Ref.: TX-3322</b>	HC2022 HC6021 a partir serie G Otras triple spray  <b>4'00€</b>  Llave Ref.: HE-1022KT
	Líneas HP Líneas HC Líneas HE  <b>Ref.: TX-SP0630</b>	Llave Ref.: HE-1922  <b>7'00€</b>

## OTROS REPUESTOS TURBINA

## Otros repuestos turbina









	Descripción	Observaciones
	Bola universal turbinas para acople KaVo® y Sirona®.  <b>Ref.: TX-0417</b>	Medida: 1,5mm  <b>1'60€</b>
	Muelle circular sistema acople KaVo® Multiflex.  <b>Ref.: TX-0418</b>	<b>13'80€</b>
	Muelle circular sistema acople Sirona® Click & Go.  <b>Ref.: TX-0418S</b>	<b>13'80€</b>

TODOS LOS REPUESTOS TURBINAS MK-dent® CONSULTE PRECIOS Y DESPIECES

## JUNTAS CONEXIÓN TURBINAS, ACOPLAMIENTOS Y MICROMOTORES

### Juntas Conexión Turbinas, Acoplamientos y Micromotores

**RUMAR**

	Descripción		Observaciones
	Conector micromotor Bien Air® MC3  <b>Ref.: TX-3008/5</b>	<b>12'80€</b>	8 agujeros Pack 5 uds.
	Conector Midwest Lux 6  <b>Ref.: TX-3006/5</b>	<b>8'00€</b>	6 agujeros Pack 5 uds.
	Conector Midwest Lux 5  <b>Ref.: TX-3005</b>	<b>2'80€</b>	5 agujeros  <b>HASTA AGOTAR</b>
	Conector Midwest 4  <b>Ref.: TX-3004/5</b>	<b>8'00€</b>	4 agujeros Pack 5 uds.
	Conector Borden 3  <b>Ref.: TX-3003</b>	<b>2'00€</b>	3 agujeros
	Conector Borden 2  <b>Ref.: TX-3002</b>	<b>2'10€</b>	2 agujeros







## LEDs Y BOMBILLAS XENON ROTATORIO

### LEDs RUMAR® para Rotatorio

RUMAR

Durabilidad: 5.000 horas  
Temperatura color: 4.500 - 5.000 °K

Tensión: 3,7 V CC/DC



	Descripción	Observaciones
	KaVo acoplamiento / micromotores. <b>Ref.: BX-001</b> (Ref. KaVo®: 1.007.5372)	30'80€
	Sirona® acoplamiento / micromotores / Sirosonic® L. <b>Ref.: BX-002</b>	30'80€
	Bien Air®, micromotores (MC2, MC3, MX y otras). <b>Ref.: BX-003</b>	30'80€
	Bien Air®, turbinas. <b>Ref.: BX-004</b>	30'80€
	NSK® acoplamiento NL / PTL. <b>Ref.: BX-005</b>	30'80€
	NSK® acoplamiento KCL / SCL, micromotor M40 y acoplamiento tipo Multiflex fabricado por NSK®. <b>Ref.: BX-007</b>	30'80€
	R-Tech®, acoplamiento conexión Multiflex. <b>Ref.: BX-341</b>	18'00€ No válido para acoplamiento KaVo.













### LEDs RUMAR® para Rotatorio

RUMAR

Durabilidad: 5.000 horas  
Temperatura color: 5.500 °K

Tensión: 3 - 3,5 V CC/DC  
Potencia: 50.000 LUX

	Descripción	Observaciones
	KaVo® / MK-dent®, acoplamiento. <b>Ref.: BX-LEDK</b> (Ref. KaVo®: 1.007.5372)	Incluye: Casquillo AX-SP0490 48'00€
	KaVo®, micromotores. <b>Ref.: BX-LEDKM</b>	38'80€
	Bien Air®, micromotores. <b>Ref.: BX-LEDBA</b>	38'80€









	Descripción	Observaciones
	<p>Bien Air®, turbinas.</p> <p><b>Ref.: BX-LEDBAK</b> <span style="float: right;"><b>38<sup>80</sup>€</b></span></p>	
	<p>Sirona®, micromotores.</p> <p><b>Ref.: BX-LEDSG</b> <span style="float: right;"><b>38<sup>80</sup>€</b></span></p>	
	<p>Sirona®, acoplamiento, ultrasonidos Sirosonic® L y jeringa SprayvitL (Excepto TSI Siemens®).</p> <p><b>Ref.: BX-LEDSB</b> <span style="float: right;"><b>38<sup>80</sup>€</b></span></p>	
	<p>W&amp;H® / ADEC turbinas.</p> <p><b>Ref.: BX-LEDWH</b> <span style="float: right;"><b>39<sup>80</sup>€</b></span></p>	
	<p>W&amp;H® Motor LT25.</p> <p><b>Ref.: BX-LEDWEA</b> <span style="float: right;"><b>39<sup>80</sup>€</b></span></p>	
	<p>NSK® acoplamiento NL / PTL.</p> <p><b>Ref.: BX-LEDN</b> <span style="float: right;"><b>38<sup>80</sup>€</b></span></p>	
	<p>NSK® micromotores NL (M40 NL400 / KCL6).</p> <p><b>Ref.: BX-LEDNNL</b> <span style="float: right;"><b>39<sup>80</sup>€</b></span></p>	
	<p>NSK® acoplamiento KCL / SCL, motor M40 y acoplamiento tipo Multiflex fabricado por NSK®.</p> <p><b>Ref.: BX-LEDNM</b> <span style="float: right;"><b>38<sup>80</sup>€</b></span></p>	
	<p>NSK® micromotores TIM40 / TI205L.</p> <p><b>Ref.: BX-LEDNT</b> <span style="float: right;"><b>39<sup>80</sup>€</b></span></p>	
	<p>Castellini®, Turbinas, 1 pin.</p> <p><b>Ref.: BX-LEDC</b> <span style="float: right;"><b>39<sup>80</sup>€</b></span></p>	
	<p>Micromotor MK-dent® EM1190K.</p> <p><b>Ref.: BX-LEDEM</b> <span style="float: right;"><b>39<sup>80</sup>€</b></span></p>	
	<p>Micromotor MK-dent® AM1006.</p> <p><b>Ref.: BX-LEDMI</b> <span style="float: right;"><b>39<sup>80</sup>€</b></span></p>	

## Bombillas Xenon RUMAR® para Rotatorio

RUMAR

Durabilidad: 300 horas

Tensión: 2,5 - 3 V CA/AC o CC/DC

	Descripción	Observaciones
	KaVo® / MK-dent® acoplamiento / micromotores. <b>Ref.: BX-XENONK</b> (Ref. KaVo®: 0.553.3881 / 1.002.2928)	13 <sup>80</sup> €
	Bien Air, micromotores. <b>Ref.: BX-XENONBA</b> (Ref. Bien Air 211.60.16 / 1500007)	14 <sup>80</sup> €
	Bien Air, turbinas. <b>Ref.: BX-XENONBAK</b> (Ref. Bien Air 204.33.07 / 1500000)	14 <sup>80</sup> €
	W&H, turbinas. <b>Ref.: BX-XENONWH</b> (Ref. W&H 02207600)	14 <sup>80</sup> €
	Sirona, acoplamiento. <b>Ref.: BX-XENONSB</b> (Ref. Sirona 5940291)	14 <sup>80</sup> €
	Sirona, micromotores. <b>Ref.: BX-XENONSG</b> (Ref. Sirona 5945407)	14 <sup>80</sup> €
	NSK, acoplamiento NL / PTL. <b>Ref.: BX-XENONN</b> (Ref. NSK Y4900529)	14 <sup>80</sup> €
	NSK, micromotores NL (M40 NL400) y acoplamiento KCL6 <b>Ref.: BX-XENONNL</b>	14 <sup>80</sup> €

# ARANDELAS Y ANILLOS TÓRICOS TURBINAS

## Arandelas Turbinas





RUMAR

	Descripción	Observaciones
	Arandela <b>metálica</b> para turbinas KaVo® 655, 660, 7000, 6000 traseira y compatibles. ***Original KaVo*** <b>Ref.: TX-5032</b> (Ref. KaVo®: 1.001.5032)	Medidas: 4,9x6,35mm 1'80€
	Arandela <b>metálica</b> para turbinas KaVo® 8000, 9000 y delantero E680L y compatibles. ***Original KaVo*** <b>Ref.: TX-5900</b> (Ref. KaVo®: 1.003.5900)	1'80€
	Arandela <b>metálica</b> para turbinas KaVo® E680L traseira, S609, S619L y compatibles. ***Original KaVo*** <b>Ref.: TX-7576</b> (Ref. KaVo®: 1.003.7576)	Medidas: 4,7x6,0x0,1mm 1'80€
	Arandela <b>metálica</b> para turbinas KaVo® 5000, 6000 delantera y compatibles. ***Original KaVo*** <b>Ref.: TX-6391</b> (Ref. KaVo®: 1.001.6391)	Medidas: 4,7x6,0 mm 1'80€
	Arandela <b>metálica</b> para turbinas W&H®. (Excepto HS2014) ***Original W&H*** <b>Ref.: TX-9408</b> (Ref. W&H®: 02749408)	1'80€
	Arandela <b>metálica</b> para turbinas Alegria® HS2014 TE-95, Alegria® HS2014 TE-97 y Alegria® HS2014 TE-98 <b>Ref.: TX-2495</b>	1'80€
	Arandela <b>metálica</b> para turbinas Bien Air® Bora, Black Pearl y compatibles. <b>Ref.: TX-2490</b>	NO Black Pearl ECO 1'30€
	Anillo de <b>Teflón</b> ancho turbinas Bien Air®. ***Original Bien Air*** <b>Ref.: TX-3452</b> (Ref. Bien Air®: 009.34.52)	Medidas: 3,25x7,9mm 2'20€
	Anillo de <b>Teflón</b> fino turbinas Bien Air. ***Original Bien Air*** <b>Ref.: TX-3456</b> (Ref. Bien Air®: 009.34.56)	Medidas: 5,1x7,9mm 1'60€

## Anillos tóricos rotores turbinas





RUMAR





	Descripción	Observaciones
	Rotores turbinas KaVo® todos los modelos MK-dent todos los modelos. <b>Ref.: OR-6172</b> (Ref. KaVo®: 0.200.6172 / MK-dent®: OR1011K)	1'80€
	Rotores turbinas Sirona® T1, Siroboost y compatibles. <b>Ref.: OR-8988</b> (Ref. Sirona®: 70 28 988 / 63 73 747)	Medidas: 1X6mm 1'80€
	Rotores turbinas Sirona® T2 Racer y compatibles ***Original Sirona*** <b>Ref.: OR-9416</b> (Ref. Sirona®: 5829416)	1'90€

	Descripción	Observaciones
	Rotores turbinas Bien Air®. (Excepto Prestige) <b>Ref.: OR-0181</b> (Ref. Bien Air®: 705.01.81)	1'00€
	Rotores turbinas Bien Air® Prestige grande. <b>***Original Bien Air***</b> <b>Ref.: OR-0235</b> (Ref. Bien Air®: 705.02.35)	5'20€ <span style="background-color: yellow;">HASTA AGOTAR</span>
	Rotores turbinas Bien Air® Prestige pequeño. <b>***Original Bien Air***</b> <b>Ref.: OR-0239</b> (Ref. Bien Air®: 705.02.39)	3'60€ <span style="background-color: yellow;">HASTA AGOTAR</span>
	Rotores turbinas NSK® X500 / 600 / 700. <b>Ref.: OR-0158</b>	1'00€
	Rotores turbinas W&H®. <b>Ref.: OR-6001</b> (Ref. W&H®: 01066001)	1'00€

## Otros Anillos Tóricos Turbinas

RUMAR

	Descripción	Observaciones
	Unión cuerpo KaVo® / MK-dent®. <b>Ref.: OR-0414</b>	1'40€
	Tubo agua, KaVo®. <b>Ref.: OR-0415</b>	1'40€
	Tubo aire KaVo® / MK-dent®. <b>Ref.: OR-0416</b>	1'50€
	Conector interno KaVo® / MK-dent®. <b>Ref.: OR-0419</b>	1'50€
	Tapa Spray KaVo® 630 / 640 y 645. MK-dent® todos los modelos excepto Prime Line. <b>Ref.: OR-6132</b> (Ref. KaVo®: 0.200.6132)	1'50€

	Descripción	Observaciones
	Tapa Spray KaVo® 647 / 650 / 655 / 6000 / 7000 y 8000. ***Original KaVo*** Ref.: <b>OR-6175</b>	Medidas: 5,6x0,5mm (Pequeño) 4'90€
	Tapa Spray KaVo® 647 / 650 / 655 / 6000 / 7000 y 8000. ***Original KaVo*** Ref.: <b>OR-6176</b> (Ref. KaVo®: 0.200.6176)	Medidas: 8,5x0,5mm (Grande) 4'50€
	Difusor spray Bien Air® Bora. Ref.: <b>OR-0431</b> (Ref. Bien Air®: 1300431 / 705.02.50)	3'80€
 <small>Imagen no disponible</small>	Anillo tórico pequeño sistema acople NSK®. Ref.: <b>OR-0414NT</b>	1'50€
	Anillo tórico grande sistema acople NSK®. Ref.: <b>OR-0412NT</b>	1'50€

## Anillos Tóricos Acoplamientos

RUMAR

## Descripción



## Observaciones

BAJADA  
PRECIO









	Kit completo, 5 anillos tóricos Kavo® Multiflex. Ref.: <b>OR-4011</b>	6'80€
	Kit completo, 4 anillos tóricos Sirona® Click & Go. Ref.: <b>OR-4000</b>	5'50€ No válidos para acoplamientos MK-dent® QC5016SW y QC6016SW.
	Anillo tórico acoplamientos MK-dent® QC5016SW y QC6016SW Ref.: <b>OR-4011S</b> (Ref. MK-dent®: OR4011S/10)	1'30€ No válidos para otros acoplamientos tipo Sirona® Click & Go
	Kit completo, 3 anillos tóricos Bien® Air Unifix. Ref.: <b>OR-4001</b>	6'50€
	Kit completo, 3 anillos tóricos W&H® Roto-Quick. Ref.: <b>OR-4012</b>	4'80€
	Kit completo, 4 anillos tóricos rm TopFlex y NSK® PanaAir. Ref.: <b>OR-4307</b>	4'80€
 <small>Imagen no disponible</small>	Anillo tórico pequeño sistema acople NSK®. Ref.: <b>OR-0414NT</b>	1'50€
	Anillo tórico grande sistema acople NSK®. Ref.: <b>OR-0412NT</b>	1'50€



	Descripción	Observaciones
	Kit completo, 5 anillos tóricos NSK®. <b>Ref.: OR-0411</b>	7 <sup>50</sup> €

**Anillos tóricos scalers y ultrasonidos** RUMAR

	Descripción	Observaciones
	Kit completo, 7 anillos tóricos scaler ECO S2. <b>Ref.: OR-ECOS2OR</b>	9 <sup>80</sup> €
	Anillo tórico conexión piezas de mano Woodpecker® y DTE®. <b>Ref.: 28-U011</b>	Pack 6 uds. 3 <sup>80</sup> €
	Anillo tórico piezas de mano Woodpecker® y DTE®. <b>Ref.: 28-U012</b>	Pack 3 uds. 2 <sup>80</sup> €

**Respuestos acoplamientos** RUMAR

	Descripción	Observaciones
	Protector bombilla acoplamiento QC5016K y QC5016KW. <b>Ref.: AX-SP0460</b>	Válida para Xenón BX-XENONK 15 <sup>80</sup> €
	Protector bombilla acoplamiento QC6016K y QC6016KW. <b>Ref.: AX-SP0490</b>	Válida para LED BX-LEDK 15 <sup>80</sup> €
	Protector bombilla acoplamiento QC5016SW. <b>Ref.: AX-SP0460S</b>	Válida para Xenón BX-XENONSG 15 <sup>80</sup> €
	Protector bombilla acoplamiento QC6016SW. <b>Ref.: AX-SP0491</b>	Válida para LED BX-LEDSB 15 <sup>80</sup> €
	Tubito entrada de aire acoplamiento Kavo® / MK-dent®. <b>Ref.: AX-SP0461</b>	3 <sup>00</sup> € <span style="background-color: yellow;">HASTA AGOTAR</span>
	Tubito salida de aire acoplamiento Kavo® / MK-dent®. <b>Ref.: AX-SP0462</b>	3 <sup>00</sup> € <span style="background-color: yellow;">HASTA AGOTAR</span>
	Tubo de aire de spray acoplamiento Kavo® / MK-dent®. <b>Ref.: AX-SP0465</b>	1 <sup>00</sup> € <span style="background-color: yellow;">HASTA AGOTAR</span>
	Válvula agua spray acoplamiento Kavo® / MK-dent®. <b>Ref.: AX-SP0466</b>	12 <sup>50</sup> € <span style="background-color: yellow;">HASTA AGOTAR</span>

	Descripción	Observaciones
	Pin acoplamiento Kavo® / MK-dent®. <b>Ref.: AX-SP0468</b>	1,00.€ <b>HASTA AGOTAR</b>
	Tornillo acoplamiento Kavo® / MK-dent®. <b>Ref.: AX-SP0481</b>	1,50.€ <b>HASTA AGOTAR</b>

# RODAMIENTOS CERÁMICOS para **TURBINA**

## MÍNIMO ABEC7



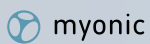







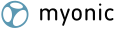

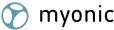

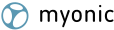

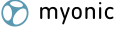
RODAMIENTOS DISEÑADOS PARA EL FUNCIONAMIENTO  
SEGÚN ESPECIFICACIONES DE CADA INSTRUMENTO

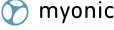

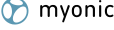

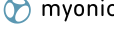

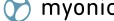
Todos los rodamientos que ofrecemos están fabricados por los principales fabricantes de rodamientos a nivel mundial: myonic®, Barden, GRW, NMB, NHBB o ESI. Todos fabricados de acuerdo a las normas de precisión ISO\* (normas para rodamientos de dimensiones métricas) y ABEC\*\* (rodamientos generalmente en dimensiones de pulgadas).

\* ISO: International Standard Organization.



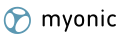

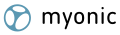



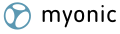

\*\* ABEC: Annular Bearing Engineers Conference.

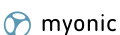
Modelos para KaVo®			Descripción
	 <p>625 627 630 639</p>	<p>640 632 642 645</p>	<p>636 646 Delantero 637 Trasero 650</p> <p><b>Ref.: ROD-6502</b> (Ref. KaVo®: 0.220.0125)</p> <p><b>23'80€</b></p> <p><b>Medidas:</b> 3,175x6,350x2,778mm Exterior: Con rebaje Bola: Cerámica Contacto: Angular Retenedor: Torlon Cerrado</p>
	 <p>625 627 630 639</p>	<p>640 632 642 645</p>	<p>636 646 Delantero 637 Trasero 650</p> <p><b>Ref.: ROD-222</b> (Ref. KaVo®: 0.220.0125)</p> <p><b>17'80€</b></p> <p><b>Medidas:</b> 3,175x6,350x2,778mm Exterior: Con rebaje Bola: Cerámica Contacto: Radial Retenedor: Torlon Cerrado</p>
	 <p>Trasero 637 Delantero 6000</p>		<p>636 646 Delantero 637 Trasero 650</p> <p><b>Ref.: ROD-352</b> (Ref. KaVo®: 0.220.2015)</p> <p><b>28'80€</b></p> <p><b>Medidas:</b> 3,175x6,350x2,381/2,778mm Exterior: Con rebaje Bola: Cerámica Contacto: Angular Retenedor: Phenolic Cerrado</p>
	 <p>Delantero 650</p>		<p>636 646 Delantero 637 Trasero 650</p> <p><b>Ref.: ROD-6501</b> (Ref. KaVo®: 0.220.2009)</p> <p><b>39'80€</b></p> <p><b>Medidas:</b> 3,175x6,350x4,178 / 3,230mm Exterior: Con rebaje Bola: Cerámica Contacto: Angular Retenedor: Torlon Cerrado</p>
	 <p>655 660 619</p>	<p>609 Delantero 8000 Delantero E679</p>	<p>Delantero E680 Delantero 6500BR</p> <p><b>Ref.: ROD-225</b> (Ref. KaVo®: 1.000.7980)</p> <p><b>23'80€</b></p> <p><b>Medidas:</b> 3,175x6,350x2,778mm Exterior: Liso Bola: Cerámica Contacto: Angular Retenedor: Torlon Cerrado</p>
	 <p>7000 Trasero 8000 Trasero E675</p>	<p>Trasero E677 S605 S615</p>	<p>Trasero 6500BR Trasero 6500B</p> <p><b>Ref.: ROD-223</b> (Ref. KaVo®: 1.000.7979)</p> <p><b>24'80€</b></p> <p><b>Medidas:</b> 3,175x6,350x2,380 / 2,778mm Exterior: Liso Bola: Cerámica Contacto: Angular Retenedor: Torlon Cerrado</p>
	 <p>5000 Delantero E675 Delantero E677</p>	<p>Trasero E679 Trasero E680 Delantero 6500B</p>	<p>Trasero 6500BR Trasero 6500B</p> <p><b>Ref.: ROD-224</b> (Ref. KaVo®: 1.007.6975)</p> <p><b>27'80€</b></p> <p><b>Medidas:</b> 3,175x6,439x2,413mm Exterior: Con rebaje Bola: Cerámica Contacto: Angular Retenedor: Torlon Cerrado</p>
	 <p>M9000 M9000L</p>		<p>Trasero 6500BR Trasero 6500B</p> <p><b>Ref.: ROD-205</b></p> <p><b>26'80€</b></p> <p><b>Medidas:</b> 3,175x6,350x2,778mm Exterior: Liso Bola: Cerámica Contacto: Angular Retenedor: Torlon Integral</p>

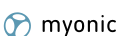
Rodamientos turbinas **Bien Air®** RUMAR

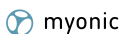
Modelos para Bien Air®			Descripción
	 <p>Bora* <b>*Excepto Bora 2</b> Black Pearl</p>	<p>Croma S Croma X Boralina Eolia</p>	<p>Rotamax L Tornado X Series TD laboratorio</p> <p><b>Medidas:</b> 3,175x7,938x3,571mm Exterior: Liso Bola: Cerámica Contacto: Angular Retenedor: Torlon Cerrado</p> <p><b>Ref.: ROD-615</b> (Ref. Bien Air: 701.01.00) <span style="float: right;"><b>21'80€</b></span></p>
	 <p>Prestige Prestilina Croma M</p>	<p>Ondine Bora 2 (no otros modelos Bora)</p>	<p><b>Medidas:</b> 3,175x6,350x2,778mm</p> <p><b>Especial</b> Exterior: Liso Bola: Cerámica Contacto: Radial Retenedor: Phenolic Cerrado</p> <p><b>Ref.: ROD-229</b> (Ref. Bien Air: 701.01.09) <span style="float: right;"><b>20'80€</b></span></p>

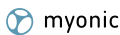
Rodamientos turbinas **Sirona® y Siemens®** RUMAR

Modelos para Sirona® / Siemens®			Descripción
	 <p>Siemens® TS1 Siemens® TS2 T1 (hasta N/S: 50.000)</p>	<p>TS1 TS2</p>	<p><b>Medidas:</b> 3,175x6,350x2,778mm Exterior: Con rebaje Bola: Cerámica Contacto: Radial Retenedor: Torlon Cerrado</p> <p><b>Ref.: ROD-222</b> <span style="float: right;"><b>17'80€</b></span></p>
	 <p>Siemens® TS1 Siemens® TS2 T1 Control (hasta N/S: 50.000)</p>	<p>TS1 TS2</p>	<p><b>Medidas:</b> 3,175x6,350x2,778mm Exterior: Con rebaje Bola: Cerámica Contacto: Angular Retenedor: Torlon Cerrado</p> <p><b>Ref.: ROD-6502</b> <span style="float: right;"><b>23'80€</b></span></p>
	 <p>T2 Control T2 Racer T3 Racer</p>	<p>TC3 T1 (N/S&gt;50.000) Siroboost</p>	<p>T2 mini T3 mini</p> <p><b>Medidas:</b> 3,175x6,350x2,778mm Exterior: Liso Bola: Cerámica Contacto: Angular Retenedor: Torlon Integral</p> <p><b>Ref.: ROD-205</b> (Ref. Sirona®: 5994814 (K)) <span style="float: right;"><b>26'80€</b></span></p>
	 <p>Siemens® TM1 Siemens® 4000ML Siemens® 4000M</p>	<p>T1 mini</p>	<p><b>Medidas:</b> 3,175x6,350x2,380mm Exterior: Con rebaje Bola: Cerámica Contacto: Radial Retenedor: Torlon Cerrado</p> <p><b>Ref.: ROD-207</b> <span style="float: right;"><b>26'80€</b></span></p>
	 <p>T1 Boost (Original) Consultar foto T2 Boost (Original) Consultar foto T3 Boost (Original) Consultar foto <b>Rotores RM consultar</b></p>		<p><b>Medidas:</b> 3,162x6,350x2,362mm Exterior: Con rebaje Bola: Cerámica Contacto: Angular Retenedor: Torlon Cerrado</p> <p><b>Ref.: ROD-232</b> (Ref. Sirona®: 6554815 y 6554807) <span style="float: right;"><b>39'80€</b></span></p>



Rodamientos turbinas **W&H®**

Modelos para W&H®		Descripción
 <p>myonic</p>	<p>Alegra® TE-95 Alegra® TE-97 Alegra® TE-98 Toda la línea Alegra® (hasta 2013)</p> <p>Top Air 196 Top Air 796 Top Air 896 Top Air TC-80</p> <p>Top Air TC-83 Top Air TC-95 Top Air TC-98</p> <p><b>Ref.: ROD-206</b> (Ref. W&amp;H: 05958600 y compatibles)</p>	<p><b>Medidas:</b> 3,175x6,350x2,778mm</p> <p>Exterior: Liso Bola: Cerámica Contacto: Radial Retenedor: Torlon Cerrado</p> <p><b>16'80€</b></p>
 <p>myonic</p>	<p>Alegra® HS2014 TE-95 (2014-actual) Alegra® HS2014 TE-97 (2014-actual) Alegra® HS2014 TE-98</p> <p>RC-95BC RC-95BM</p> <p><b>Ref.: ROD-235</b></p>	<p><b>Medidas:</b> 3,175x6,310/6,350/7,518x2,778mm</p> <p>Exterior: Reborde Bola: Cerámica Contacto: Radial Retenedor: Torlon Cerrado</p> <p><b>23'80€</b></p>
 <p>myonic</p>	<p>Synea® TA-96 Synea® TA-97 Synea® TA-98 Toda la línea Synea® Trend</p> <p>TK-97LM TK-98LM TK-100LM TG-97L TG-98L</p> <p>TA-97LW Top Air 195, 198, 398 Top Air 698, 795, 797 Top Air 798, 895, 898</p> <p><b>Ref.: ROD-205</b> (Ref. W&amp;H: 02770712, 04378600, 05288500 y compatibles)</p>	<p><b>Medidas:</b> 3,175x6,350x2,778mm</p> <p>Exterior: Liso Bola: Cerámica Contacto: Angular Retenedor: Torlon Integral</p> <p><b>26'80€</b></p>
 <p>myonic</p>	<p>395 396 695</p> <p>696 TK-94L TK-94LM</p> <p><b>Ref.: ROD-226</b></p>	<p><b>Medidas:</b> 3,175x6,350x2,380mm</p> <p>Exterior: Liso Bola: Cerámica Contacto: Angular Retenedor: Torlon Integral</p> <p><b>27'80€</b></p>

Rodamientos turbinas **NSK®**

\*Las letras "K", "S", "W" y "B" indican el sistema de acople de la turbina y **no influyen** en el modelo del rotor

\*\* En los modelos **X500, X600 y X700**, sólo es posible cambiar los rodamientos en rotores compatibles. A pesar de ser los mismos rodamientos, en los originales los rodamientos están soldados al eje por lo que no es posible cambiarlos.

Modelos para NSK®		Descripción
 <p>myonic</p>	<p>Aqua Presto Alpha Light</p> <p>Phatelus</p> <p><b>Ref.: ROD-227</b></p>	<p><b>Medidas:</b> 3,175x6,350/7,518x2,778mm</p> <p>Exterior: Con rebaje Bola: Cerámica Contacto: Radial Retenedor: Phenolic Cerrado</p> <p><b>19'80€</b></p>
 <p>myonic</p>	<p>Ti-MAX X600/L* Ti-MAX X700/L* Ti-MAX NL9000S/ T/ M</p> <p>Trasero Ti-MAX X500/L* S-Max M600/L* S-Max M900/L*</p> <p><b>Ref.: ROD-226**</b></p>	<p><b>Medidas:</b> 3,175x6,350x2,380mm</p> <p>Exterior: Liso Bola: Cerámica Contacto: Angular Retenedor: Torlon Integral</p> <p><b>27'80€</b></p>
 <p>myonic</p>	<p>Delantero X500/L*</p> <p><b>Ref.: ROD-207</b></p>	<p><b>Medidas:</b> 3,175x6,350x2,380mm</p> <p>Exterior: Con rebaje Bola: Cerámica Contacto: Radial Retenedor: Torlon Cerrado</p> <p><b>26'80€</b></p>

**Modelos para NSK®**

**Descripción**



myonic

Trasero Ti-MAX A400/L\*  
Ti-MAX A300/L\*  
NL65-CH  
QD-NL45-MACH  
Trasero Pana Max T  
Trasero Pana Max QD-T  
N75-MACH  
Trasero Pana Max S  
Trasero Pana Max QD-S  
Pana Max PAX-TU M4/B2  
Pana-Max PAX-SU M4/B2  
Mach-Lite S  
Mach-Lite XT-M  
Mach-Lite XT-MU  
Ti-MAX A200/L\*  
NL75  
NL85

NL75 Mach-Lite M  
NL85 Mach-Lite M  
Mach 2 M/MU  
Mach QD-M  
Mach QD-S  
Mach-Lite XT T/TU  
Mach 2 T/TU  
NL65 Mach-Lite S  
NL75 Mach-Lite S  
NL85 Mach-Lite S  
NL65 Mach-Lite T  
NL75 Mach-Lite T  
NL85 Mach-Lite T  
Mach-Lite XT S/SU  
Mach 2 S/SU  
Pana Air Σ SU M4/B2  
NL65

NL45T  
Phatelus 45 T/TU  
Phatelus II T/TU  
MACH-QD T  
Ti-MAX A455/L\*  
Phatelus III T/TU  
Mach-Lite M  
Phatelus II M/MU  
NL65M  
Ti-MAX A600/L\*  
Ti-MAX NL95S  
Ti-MAX NL45S  
Ti-MAX A700/L\*  
Ti-MAX NL95T  
Ti-MAX NL45T

**Medidas:** 3,175x6,350x2,381mm  
Exterior: Liso  
Bola: Cerámica  
Contacto: Radial  
Retenedor: Phenolic  
Cerrado

Ref.: **ROD-228**

17<sup>80</sup>€

**Rodamientos turbinas Morita®**

**RUMAR**

**Modelos para Morita®**

**Descripción**



myonic

TwinPower **PAR-4HEX-O**  
TwinPower **PAR-4HUEX-O**  
TwinPower **PAR-4HX-O**

Ref.: **ROD-226**

27<sup>80</sup>€

**Medidas:** 3,175x6,350x2,380mm  
Exterior: Liso  
Bola: Cerámica  
Contacto: Angular  
Retenedor: Torlon  
Integral

**Rodamientos turbinas Castellini®, Anthos® y Cefla®**

**RUMAR**

**Modelos para Castellini®, Anthos®, Stern Weber® y Cefla®**

**Descripción**



myonic

Gold  
Silent Power

Ref.: **ROD-205**

26<sup>80</sup> €

**Medidas:** 3,175x6,350x2,778mm  
Exterior: Liso  
Bola: Cerámica  
Contacto: Angular  
Retenedor: Torlon  
Integral



myonic

Clean Air 2000  
High Power M

Ref.: **ROD-227**

19<sup>80</sup>€

**Medidas:** 3,175x6,350/7,518x2,778mm  
Exterior: Con rebaje  
Bola: Cerámica  
Contacto: Radial  
Retenedor: Phenolic  
Cerrado

**Rodamientos turbinas FARO®**

**RUMAR**

**Modelos para Faro®**

**Descripción**



myonic

S404

Ref.: **ROD-205**

26<sup>80</sup>€

**Medidas:** 3,175x6,350x2,779 mm  
Exterior: Liso  
Bola: Cerámica  
Contacto: Angular  
Retenedor: Torlon  
Integral

## Rodamientos turbinas Lares®

RUMAR

Modelos para Lares®		Descripción
 <p>myonic</p>	<p>557CX 757CX</p> <p>Ref.: <b>ROD-226</b></p>	<p><b>Medidas:</b> 3,175x6,350x2,380mm</p> <p>Exterior: Liso Bola: Cerámica Contacto: Angular Retenedor: Torlon Integral</p> <p><b>27'80€</b></p>



## Rodamientos turbinas TKD®

RUMAR

Modelos para TKD®		Descripción
 <p>myonic</p>	<p>Bravía Thera</p> <p>Ref.: <b>ROD-226</b></p>	<p><b>Medidas:</b> 3,175x6,350x2,380mm</p> <p>Exterior: Liso Bola: Cerámica Contacto: Angular Retenedor: Torlon Integral</p> <p><b>27'80€</b></p>

## Rodamientos turbinas KMD®











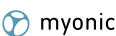

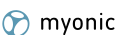

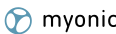
RUMAR

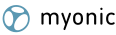
Modelos para KMD®		Descripción
 <p>myonic</p>	<p>Mistral M4-DPS</p> <p>Ref.: <b>ROD-228</b></p>	<p><b>Medidas:</b> 3,175x6,350x2,381mm</p> <p>Exterior: Liso Bola: Cerámica Contacto: Radial Retenedor: Phenolic Cerrado</p> <p><b>17'80€</b></p>
 <p>myonic</p>	<p>Solaris</p> <p>Ref.: <b>ROD-205</b></p>	<p><b>Medidas:</b> 3,175x6,350x2,778mm</p> <p>Exterior: Liso Bola: Cerámica Contacto: Angular Retenedor: Torlon Integral</p> <p><b>26'80€</b></p>

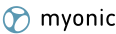
## Rodamientos turbinas R-Tech®

R-Tech®

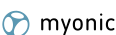





Modelos para R-Tech®		Descripción
 <p>myonic</p>	<p>Powermax</p> <p>Ref.: <b>ROD-226</b></p>	<p><b>Medidas:</b> 3,175x6,350x2,380mm</p> <p>Exterior: Liso Bola: Cerámica Contacto: Angular Retenedor: Torlon Integral</p> <p><b>27'80€</b></p>

Modelos para MK-dent®				Descripción	
	 <p>Delantero HC9021 Delantero HC8021 Delantero HP21</p>	<p>Delantero HP21L Delantero HC20 Delantero HC20L</p>	<p>Delantero HC21 Delantero HC21L</p>	<p><b>Medidas:</b> 3,175x6,350x2,778mm</p> <p>Exterior: Liso Bola: Cerámica Contacto: Angular Retenedor: Torlon Integral</p>	
<b>Ref.:</b>	<b>ROD-205</b>			<b>26'80€</b>	
	 <p>Trasero HC9021 Trasero HC8021 Trasero HP21</p>	<p>Trasero HP21L Trasero HC20 Trasero HC20L</p>	<p>Trasero HC21 Trasero HC21L Trasero HE22 Trasero HE22L</p>	<p><b>Medidas:</b> 3,175x6,350x2,380 / 2,778mm</p> <p>Exterior: Liso Bola: Cerámica Contacto: Angular Retenedor: Torlon Cerrado</p>	
<b>Ref.:</b>	<b>ROD-223</b>			<b>24'80€</b>	
	 <p>Delantero HE17 (Todos N/S) Delantero HE21 Delantero HE21L</p>			<p><b>Medidas:</b> 3,175x6,350x2,778mm</p> <p>Exterior: Liso Bola: Cerámica Contacto: Angular Retenedor: Torlon Cerrado</p>	
<b>Ref.:</b>	<b>ROD-225</b>			<b>23'80€</b>	
	 <p>HC7032 HC7031 HC7022 HC6022 (según N/S)</p>	<p>HC6012 HC5032 HC5031 HC5021</p>	<p>HC4022 HC4021 HC4012 HC2022</p>	<p>HC2012 Delantero HP21 Delantero HP21L</p>	<p><b>Medidas:</b> 3,175x6,350x2,778mm</p> <p>Exterior: Con rebaje Bola: Cerámica Contacto: Angular Retenedor: Torlon Cerrado</p>
<b>Ref.:</b>	<b>ROD-6502</b>			<b>23'80€</b>	
	 <p>HC22 HC22L HP22</p>	<p>HP22L HC8022 HC9022</p>		<p><b>Medidas:</b> 3,175x6,350x2,381/2,778mm</p> <p>Exterior: Con rebaje Bola: Cerámica Contacto: Angular Retenedor: Phenolic Cerrado</p>	
<b>Ref.:</b>	<b>ROD-352</b>			<b>28'80€</b>	
	 <p>Trasero HE21 Trasero HE21L Trasero HE17 (HE010000 &lt; N/S &lt; HE023799)</p>		<p>Delantero HE22 Delantero HE22L</p>	<p><b>Medidas:</b> 3,175x6,439x2,413mm</p> <p>Exterior: Con rebaje Bola: Cerámica Contacto: Angular Retenedor: Torlon Cerrado</p>	
<b>Ref.:</b>	<b>ROD-224</b>			<b>27'80 €</b>	
	 <p>Trasero HC20 Trasero HC20L Trasero HE17 (N/S &gt; HE023800)</p>			<p><b>Medidas:</b> 3,175x6,350x2,381mm</p> <p>Exterior: Liso Bola: Cerámica Contacto: Radial Retenedor: Phenolic Cerrado</p>	
<b>Ref.:</b>	<b>ROD-228</b>			<b>17'80€</b>	

# REPUESTOS PARA CONTRA ÁNGULOS Y PIEZAS DE MANO KAVO®



Repuestos compatibles destacados contra ángulos KaVo®

RUMAR

	Modelos para KaVo®	Relacionados
	<p>Conjunto repuestos cabeza (Rotor completo + carcasa + botón + eje + tornillo + muelle)</p> <p>INTRAlux® 68LH INTRA® L68</p> <p><b>Ref.: BVX-7401</b> (Ref. KaVo®: 0.540.2040 / 1.008.1833)</p>	<b>164<sup>80</sup>€</b>
	<p>Conjunto repuestos cabeza (Rotor completo + carcasa + botón + eje + tornillo + muelle)</p> <p>68LDN</p> <p><b>Ref.: BVX-7400</b> (Ref. KaVo®: 0.540.2010)</p>	<b>164<sup>80</sup>€</b>
	<p>Conjunto repuestos cabeza (Rotor completo + carcasa + botón + eje + tornillo + muelle)</p> <p>INTRAlux® 67LH INTRA® L67</p> <p><b>Ref.: BVX-7402</b> (Ref. KaVo®: 0.540.3641 / 1.008.1832)</p>	<b>164<sup>80</sup>€</b>
	<p>Conjunto repuestos cabeza (Rotor completo + carcasa + botón + eje + tornillo + muelle)</p> <p>INTRAlux® CL3</p> <p><b>Ref.: BVX-7403</b> (Ref. KaVo®: 1.001.8993)</p>	<b>178<sup>00</sup>€</b>
	<p>Conjunto repuestos cabeza (Rotor completo + carcasa + botón + eje + tornillo + muelle)</p> <p>INTRAlux® 80LD INTRA® L80</p> <p><b>Ref.: BVX-7404</b> (Ref. KaVo®: 0.540.1830 / 1.004.4456)</p>	<b>178<sup>00</sup>€</b>
	<p>Conjunto repuestos cabeza (Rotor completo + carcasa + botón + eje + tornillo + muelle)</p> <p>SURGmatic® S201XL SURGmatic® S201XC</p> <p><b>Ref.: BVX-7405</b> (Ref. KaVo®: 1.010.3000)</p>	<b>194<sup>80</sup>€</b>

Rotores compatibles contra ángulos KaVo®

RUMAR

	Modelos para KaVo®	Relacionados
	<p>INTRA LUX 68LU      EXPERTmatic E20L      INTRAcompact 2068CHC</p> <p>INTRA LUX 68LH      EXPERTmatic E20C</p> <p>INTRAhead L68      INTRAcompact 2068LHC</p> <p><b>Ref.: BVR-705</b> (Ref. KaVo®: 0.540.3661)</p>	<p>Eje Ref.: BVE-724 Tapa Ref.: BVT-704 Conjunto repuestos cabeza: BVX-7401</p> <p><b>94<sup>80</sup>€</b></p>
	<p>INTRA LUX 67LH      EXPERTmatic E15L      INTRAcompact 0767CHC</p> <p>INTRA L67      EXPERTmatic E15C</p> <p>INTRA 67LHB      INTRAcompact 0767LHC</p> <p><b>Ref.: BVR-468</b> (Ref. KaVo®: 0.540.3671)</p>	<p>Eje Ref.: BVE-398 Tapa Ref.: BVT-704 Conjunto repuestos cabeza: BVX-7402</p> <p><b>99<sup>80</sup>€</b></p>

	Modelos para KaVo®	Relacionados
	<p>INTRA LUX 68LDN</p> <p>Ref.: <b>BVR-720</b> (Ref. KaVo®: 0.540.2491)</p>	<p>Eje Ref.: BVE-724 Tapa Ref.: BVT-711 Conjunto repuestos cabeza: BVX-7400</p> <p><b>84<sup>80</sup>€</b></p>
	<p>INTRA LUX C3 INTRA LUX CL3 SURGmatic S201L</p> <p>Ref.: <b>BVR-414</b> (Ref. KaVo®: 1.001.4490)</p>	<p>Eje Ref.: BVE-402 Tapa Ref.: BVT-401 Conjunto repuestos cabeza: BVX-7403</p> <p><b>128<sup>00</sup>€</b></p>
	<p>INTRAmatic 25LH      INTRAmatic 25CN      INTRAmatic LUX 24LS INTRAmatic LHC      INTRAmatic 25CH INTRAmatic 25LHS      INTRAmatic LUX 24LN</p> <p>Ref.: <b>BVR-370K</b> (Ref. KaVo®: 0.553.7341 / 0.553.5761)</p>	<p>Eje Ref.: BVE-460 Segundo Eje Ref.: BVE-462</p> <p><b>228<sup>00</sup>€</b></p>
	<p>EXPERTmatic E25 EXPERTmatic E25L</p> <p>Ref.: <b>BVR-372K</b> (Ref. KaVo®: 1.008.4040)</p>	<p>Eje Ref.: BVE-449 Tapa Ref.: BVT-446</p> <p><b>228<sup>00</sup>€</b></p>
	<p>GENTLEpower LUX 25LP      COMFORTdrive 200XD GENTLEpower LUX 25LPA      COMFORTdrive 200XDR</p> <p>Ref.: <b>BVR-371K</b> (Ref. KaVo®: 1.001.3520 / 1.002.6135)</p>	<p>Eje Ref.: BVE-448</p> <p><b>228<sup>00</sup>€</b></p>
	<p>MASTERmatic Lux M25L</p> <p>Ref.: <b>BVR-424</b> (Ref. KaVo®: 1.011.0129)</p>	<p>Eje Ref.: BVE-448 Tapa Ref.: BVT-447</p> <p><b>188<sup>00</sup>€</b></p>
	<p>MASTERmatic® LUX M05L</p> <p>Ref.: <b>BVR-425</b> (Ref. KaVo®: 1.011.1374 / 1.009.3643)</p>	<p>Eje Ref.: BVE-463 Segundo Eje Ref.: BVE-462 Tapa Ref.: BVT-448</p> <p><b>222<sup>80</sup>€</b></p>
	<p>Piñón transmisión 1:1 para: INTRA LUX 68LU      EXPERTmatic E20L INTRA LUX 68LH      INTRAccompact 2068LHC INTRAhead L68</p> <p>Ref.: <b>BVR-701</b> (Ref. KaVo®: 0.540.4012)</p>	<p><b>37<sup>80</sup>€</b></p>
	<p>Piñón transmisión 1:1 para: INTRA LUX 68LDN</p> <p>Ref.: <b>BVR-710</b> (Ref. KaVo®: 0.540.4092)</p>	<p><b>44<sup>80</sup>€</b></p>
	<p>Piñón reducción 2:1 para: INTRA LUX 67LH INTRA L67 INTRA 67LHB</p> <p>Ref.: <b>BVR-721</b> (Ref. KaVo®: 0.540.4022)</p>	<p><b>38<sup>80</sup>€</b></p>

## Modelos para KaVo®

## Relacionados









	<p>Corona para: 67RIC ***Original KaVo***</p> <p><b>Ref.: BVR-805</b> (Ref. KaVo®: 0.540.2761)</p>	<p><b>101<sup>80</sup>€</b></p> <p>HASTA AGOTAR</p>
---	--	---



## Ejes compatibles contra ángulos KaVo®

RUMAR

## Modelos para KaVo®







## Relacionados

	<p>INTRA LUX 68LH INTRA LUX 68LDN INTRAhead L80 INTRAhead L68</p> <p><b>Ref.: BVE-724</b> (Ref. KaVo®: 0.540.1151)</p>	<p>INTRA LUX 52LDN INTRA LUX 80LD EXPERTmatic E20L INTRA 80C</p> <p>INTRAccompact 2068LHC INTRAccompact 2068CHC</p> <p><b>48<sup>00</sup>€</b></p>
	<p>INTRA LUX 67LH INTRA 67LHB INTRA 67LDN</p> <p>INTRA 67G INTRA L67 INTRA 67CN</p> <p>67HC INTRAprophy L31 31LR</p> <p><b>Ref.: BVE-398</b> (Ref. KaVo®: 0.540.1161)</p>	<p><b>48<sup>00</sup>€</b></p>
	<p>Corona eje de transmisión para: 68LH 68LDN L68</p> <p><b>Ref.: BVE-725</b></p>	<p><b>9<sup>80</sup>€</b></p>
	<p>INTRA LUX CL3 SURGmatic S201L</p> <p>INTRA LUX C3 INTRA LUX CP3</p> <p><b>Ref.: BVE-402</b> (Ref. KaVo®: 1.003.4207)</p>	<p><b>58<sup>00</sup>€</b></p>
	<p>INTRAccompact 2068LHC INTRAccompact 2068CHC EXPERTmatic® E20C</p> <p>EXPERTmatic® Lux E20L EXPERTmatic® S20 EXPERTmatic® S20S</p> <p>MASTERmatic® Lux M20L</p> <p><b>Ref.: BVE-1010</b> (Ref. KaVo®: 0.534.0681)</p>	<p><b>38<sup>00</sup>€</b></p>
	<p>INTRAmatic 25LH INTRAmatic 25LHS INTRAmatic 25CN</p> <p>INTRAmatic 25CH</p> <p><b>Ref.: BVE-460</b> (Ref. KaVo®: 0.553.7201)</p>	<p><b>148<sup>00</sup>€</b></p>
	<p>GENTLEpower LUX 25LP GENTLEpower LUX 25LPA MASTERmatic Lux M25L</p> <p><b>Ref.: BVE-448</b> (Ref. KaVo®: 1.001.3515)</p>	<p><b>149<sup>80</sup>€</b></p>
	<p>EXPERTmatic E25 EXPERTmatic E25L</p> <p><b>Ref.: BVE-449</b> (Ref. KaVo®: 1.007.9916)</p>	<p><b>158<sup>00</sup>€</b></p>

	Modelos para KaVo®	Relacionados
	Eje "segundo" GENTLEpower LUX 25LP Eje "segundo" GENTLEpower LUX 25LPA Eje "segundo" MASTERmatic M05L  <b>Ref.: BVE-462</b> (Ref. KaVo®: 1.001.3519)	<b>139<sup>80</sup>€</b>
	MASTERmatic® LUX M05L  <b>Ref.: BVE-463</b> (Ref. KaVo®: 1.011.3206)	<b>169<sup>80</sup>€</b>





### Tapas compatibles contra ángulos KaVo®

RUMAR















	Modelos para KaVo®	Relacionados
	INTRA LUX 68LH INTRA LUX 67LH INTRA LUX L68 INTRA LUX L67  INTRAmatic 25LH INTRAmatic 25LHS INTRAmatic 25CN INTRAmatic 25CH  INTRAmatic 25LS INTRAmatic LUX 24LN EXPERTmatic E20C  <b>Ref.: BVT-704</b> (Ref. KaVo®: 0.540.3741)	Llave Doble Ref.: HE-751  <b>25<sup>80</sup>€</b>
	INTRA LUX 68LDN INTRA LUX 67LDN INTRA LUX 68CDN  <b>Ref.: BVT-711</b> (Ref. KaVo®: 0.540.2501)	Llave Doble Ref.: HE-751  <b>29<sup>80</sup>€</b>
	INTRA LUX CL3 INTRA LUX C3 SURGICmatic S201L  <b>Ref.: BVT-401</b> (Ref. KaVo®: 0.201.8958 + 0.540.3752 + 1.001.4486)	Llave Ref.: HE-832  <b>28<sup>00</sup>€</b>
	EXPERTmatic E25L EXPERTmatic E25C  <b>Ref.: BVT-446</b> (Ref. KaVo®: 1.008.1488)	Llave Ref.: HE-819  <b>24<sup>80</sup>€</b>
	MASTERmatic Lux M25L  <b>Ref.: BVT-447</b> (Ref. KaVo®: 1.009.3634 + 0.201.8157 + 1.009.3638)	<b>24<sup>80</sup>€</b>
	MASTERmatic® Lux M05L*  <b>Ref.: BVT-448</b> (Ref. KaVo®: 3.000.6597 + 0.201.8157 + 3.000.6319)	Llave Ref.: HE-850  * Llave HE-850 necesaria, puntos de contacto distintos a original  <b>61<sup>80</sup>€</b>

Anillos Tóricos Contra Ángulos y Piezas de Mano **KaVo®**

RUMAR

	Descripción			Observaciones
	20CN 20LN 20CH	20LH 10CH 10LH	E20C E20CL	
	<b>Ref.: OR-1020</b> (Ref. KaVo®: 0.200.6099)			<b>1'80€</b>
	EXPERTmatic® E25 / E25L GENTLEpower® 25LP / 25LPA MASTERmatic® LUX M05L	MASTERmatic® LUX M25L OTROS MODELOS		Pack 1 uds.
	<b>***Original KaVo***</b>			
	<b>Ref.: OR-4929</b> (Ref. KaVo®: 1.003.4929 / 10)			<b>3'40€</b>
	EXPERTmatic® E25 / E25L GENTLEpower® 25LP / 25LPA MASTERmatic® LUX M05L	MASTERmatic® LUX M25L OTROS MODELOS		Pack 1 uds.
	<b>***Original KaVo***</b>			
	<b>Ref.: OR-3289</b> (Ref. KaVo®: 1.001.3289 / 10)			<b>2'80€</b>
 <small>Imagen no disponible</small>	EXPERTmatic® E25 / E25L GENTLEpower® 25LP / 25LPA	MASTERmatic® LUX M05L MASTERmatic® LUX M25L	OTROS MODELOS	Pack 1 uds.
	<b>***Original KaVo***</b>			
	<b>Ref.: OR-6045</b> (Ref. KaVo®: 0.200.6045)			<b>4'40€</b>







## Resto repuestos compatibles contra ángulos KaVo®

	Descripción		Observaciones
	Carcasa 68LH <b>Ref.: BVX-706</b> (Ref. KaVo®: 0.540.3631)	54'80€	
	Carcasa 67LH <b>Ref.: BVX-2101</b> (Ref. KaVo®: 0.540.3641)	63'80€	
	Carcasa 80LD <b>Ref.: BVX-2221</b> (Ref. KaVo®: 0.540.2381)	58'00€	HASTA AGOTAR
	Carcasa completa 68LDN, 68GDN <b>Ref.: BVX-712</b> (Ref. KaVo®: 0.540.2231)	58'80€	
	Segmento 68LH, L68, 67LH, L67, 68LDN y 67LDN <b>Ref.: BVX-702</b> (Ref. KaVo®: 0.540.4102)	7'80€	
	Chaveta 68LH, L68, 67LH, L67, 68LDN y 67LDN <b>Ref.: BVX-703</b> (Ref. KaVo®: 0.540.4522)	12'80€	
	Anillo de conducción 68LH, L68, 67LH, L67, 68LDN y 67LDN <b>Ref.: BVX-707</b> (Ref. KaVo®: 0.540.4072)	1'10€	Útil Ref.: HE-752
	Muelle 68LH, L68, 67LH, L67, 68LDN y 67LDN <b>Ref.: BVX-709</b> (Ref. KaVo®: 0.540.3162)	2'60€	
	Muelle para 20LH, 2068CHC, 2068LHC, 20CH, E20 y E20L <b>Ref.: BVX-1014</b> (Ref. KaVo®: 0.201.8022)	1'80€	
	Tornillo 68LH, L68, 67LH, L67, 68LDN y 67LDN <b>Ref.: BVX-708</b> (Ref. KaVo®: 0.201.0005)	1'90€	Destornillador: HE-2016, HE-753TOR.
	Anillo cierre para 20LH, 2068CHC, 2068LHC, 20CH, 20CH, E20 y E20L <b>Ref.: BVX-1003</b> (Ref. KaVo®: 0.534.4012)	26'40€	HASTA AGOTAR
	Anillo alambre para 20LH, 2068CHC, 2068LHC, 20CH, E20, E20L y compatibles <b>Ref.: BVX-1005</b> (Ref. KaVo®: 0.534.3532)	1'80€	
	Bola para 20LH, 2068CHC, 2068LHC, 20CH, E20 y E20L <b>Ref.: BVX-1006</b> (Ref. KaVo®: 0.257.4118)	1'80€	3,0 mm
	Bola para 20LH, 2068CHC, 2068LHC, 20CH, E20 y E20L <b>Ref.: BVX-1007</b> (Ref. KaVo®: 0.257.4105)	0'80€	1,5 mm HASTA AGOTAR

	Descripción	Observaciones
	Distanciadore para 20LH, 2068CHC, 2068LH, 20CHC, E20 y E20L <b>Ref.: BVX-1012</b> (Ref. KaVo®: 0.553.1602)	4´70€ <b>HASTA AGOTAR</b>
	Tope arrastre trasero para 20LH, 2068CHC, 2068LHC, 20CH, E20 y E20L <b>Ref.: BVX-1016</b> (Ref. KaVo®: 0.524.3182)	30´80€
	Pasador tope de arrastre para 20LH, 2068LHC, 20CH, E20 y E20L <b>Ref.: BVX-1017</b> (Ref. KaVo®: 0.202.0504)	1´50€
	Inserto 20CH, 2068CHC y E20 <b>Ref.: BVX-1019</b> (Ref. KaVo®: 0.534.4042)	65´90€ <b>HASTA AGOTAR</b>
	Guía posicionamiento 20LH, 2068LH y E20L (NO válido para líneas LE, LC o LP) <b>Ref.: BVX-1023</b> (Ref. KaVo®: 0.534.2442)	19´60€ <b>HASTA AGOTAR</b>
	MASTERmatic® LUX M05L MASTERmatic® LUX M25L <b>Ref.: BVX-3643</b> (Ref. KaVo®: 1.009.3643)	2´80€

## Repuestos piezas de mano KaVo®

RUMAR









	Descripción	Observaciones
	Anillo cierre para 10LH y 10CH <b>Ref.: BVX-1039</b> (Ref. KaVo®: 0.524.1561)	55´80€
	Cartucho para rodamiento 10LH y 10CH <b>Ref.: BVX-1040</b> (Ref. KaVo®: 0.524.3252)	48´20€ <b>HASTA AGOTAR</b>
	Anillo para 10LH y 10CH <b>Ref.: BVX-1041</b> (Ref. KaVo®: 0.524.2742)	8´00€ <b>HASTA AGOTAR</b>
	Perno para 10LH y 10CH <b>Ref.: BVX-1042</b> (Ref. KaVo®: 0.524.3262)	5´50€ <b>HASTA AGOTAR</b>
	Anillo roscado para 10LH y 10CH <b>Ref.: BVX-1043</b> (Ref. KaVo®: 0.524.2772)	6´90€ <b>HASTA AGOTAR</b>
	Arandela para 10LH y 10CH <b>Ref.: BVX-1044</b> (Ref. KaVo®: 0.524.2762)	4´40€ <b>HASTA AGOTAR</b>
	Tornillo para 10LH y 10CH <b>Ref.: BVX-1045</b> (Ref. KaVo®: 0.201.0401)	1´40€ <b>HASTA AGOTAR</b>

	Descripción	Observaciones
	Inserto para 10LH y 10CH  <b>Ref.: BVX-1046</b> (Ref. KaVo®: 0.524.4012)	64 <sup>20</sup> € <span style="float: right; background-color: yellow; padding: 2px;">HASTA AGOTAR</span>
	Clip para 10LH y 10CH  <b>Ref.: BVX-1047</b> (Ref. KaVo®: 0.524.3642)	1 <sup>90</sup> € <span style="float: right; background-color: yellow; padding: 2px;">HASTA AGOTAR</span>
	Tope arrastre trasero para 10LH y 10CH  <b>Ref.: BVX-1016</b> (Ref. KaVo®: 0.524.3182)	30 <sup>80</sup> €
	Pasador tope arrastre para 10LH y 10CH  <b>Ref.: BVX-1017</b> (Ref. KaVo®: 0.202.0504)	1 <sup>50</sup> €

# REPUESTOS PARA CONTRA ÁNGULOS Y PIEZAS DE MANO NSK®

Rotores compatibles destacados contra ángulos NSK®

RUMAR









	Modelos para NSK®	Relacionados
	<p>Conjunto repuestos cabeza (Rotor completo + carcasa + botón + eje + tornillo + muelle)</p> <p>S-Max M95 (Modelo antiguo) S-Max M95L (Modelo antiguo)</p> <p><b>Ref.: BVX-7426</b> (Ref. NSK®: 10000558+C600015+10000559+10000664) <b>258<sup>00</sup>€</b></p>	<p>BVR-384 BVE-386 BVT-404</p>
	<p>Conjunto repuestos cabeza (Rotor completo + carcasa + botón + eje + tornillo + muelle)</p> <p>S-Max M95 (Modelo nuevo) S-Max M95L (Modelo nuevo)</p> <p><b>Ref.: BVX-7427</b> (Ref. NSK®: 10000558+C600015+C601022+10000664) <b>258<sup>00</sup>€</b></p>	<p>BVR-384 BVE-399 BVT-404</p>
	<p>Conjunto repuestos cabeza (Rotor completo + carcasa + botón + eje + tornillo + muelle)</p> <p>S-Max M25 (Rotor cerrado*) S-Max M25L (Rotor cerrado*)</p> <p><b>Ref.: BVX-7420</b> (Ref. NSK®: 10000573+C601015+10000574+C601050) <b>138<sup>00</sup>€</b></p>	<p>BVR-388 BVE-390 BVT-387</p> <p><b>*Incluye juntas, retenedor y tórica</b> *Para rotores abiertos ver Ref.: BVX-7421</p>
	<p>Conjunto repuestos cabeza (Rotor completo + carcasa + botón + eje + tornillo + muelle)</p> <p>S-Max M25 (Rotor abierto*) S-Max M25L (Rotor abierto*)</p> <p><b>Ref.: BVX-7421</b> (Ref. NSK®: C1142011+C1142050+C1038015+C1142022) <b>138<sup>00</sup>€</b></p>	<p>BVR-457 BVE-423 BVT-419</p> <p><b>*Incluye juntas, retenedor y tórica</b> *Para rotores cerrados ver Ref.: BVX-7420</p>
	<p>Conjunto repuestos cabeza (Rotor completo + carcasa + botón + eje + tornillo + muelle)</p> <p>Ti-Max X-SG20 Ti-Max X-SG20L</p> <p><b>Ref.: BVX-7423</b> (Ref. NSK®: 10000254+C1010150+C1003022+10000228) <b>164<sup>80</sup>€</b></p>	<p>BVR-394 BVE-422 BVT-391</p>
	<p>Conjunto repuestos cabeza (Rotor completo + carcasa + botón + eje + tornillo + muelle)</p> <p>Ti-Max X25 Ti-Max X25L</p> <p><b>Ref.: BVX-7422</b> (Ref. NSK®: C601011B+C601015+C601022+C601050) <b>144<sup>80</sup>€</b></p>	<p>BVR-388 BVE-389 BVT-387</p> <p><b>*Incluye juntas, retenedor y tórica</b></p>
	<p>Conjunto repuestos cabeza (Rotor completo + carcasa + botón + eje + tornillo + muelle)</p> <p>Ti-Max X95 Ti-Max X95L</p> <p><b>Ref.: BVX-7428</b> (Ref. NSK®: C600011B + C600015 + C600B050 + C600022) <b>258<sup>00</sup>€</b></p>	<p>BVR-384 BVE-385 BVT-404</p> <p><b>*Incluye juntas, retenedor y tórica</b></p>
	<p>Conjunto repuestos cabeza (Rotor completo + carcasa + botón + eje + tornillo + muelle)</p> <p>S-Max SG20</p> <p><b>Ref.: BVX-7425</b> (Ref. NSK®: C1010911+C1010150+C1010022+10000228) <b>164<sup>80</sup>€</b></p>	<p>BVR-394 BVE-395 BVT-391</p>
	<p>Conjunto repuestos cabeza (Rotor completo + carcasa + botón + eje + tornillo + muelle)</p> <p>Ti-Max X-DSG20L</p> <p><b>Ref.: BVX-7424</b> (Ref. NSK®: C1068910+C1010150+C1068912+10000228) <b>258<sup>00</sup>€</b></p>	<p>BVR-394 BVE-450 BVT-391</p>

NUEVO



Imagen no disponible

## Rotores compatibles contra ángulos NSK®

	Modelos para NSK®	Relacionados
	Ti-Max Ti25 Ti-Max Ti25L Ti-Max Ti15  <b>Ref.: BVR-380</b>	Ti-Max Ti15L FPB-Y FFB-Y  <b>68'80€</b>
	Ti-Max X95 Ti-Max X95L S-MAX M95  <b>Ref.: BVR-384</b> (Ref. NSK®: C600 015 / C600C015003 / C600C015002)	S-MAX M95L  <b>159'80€</b>
	Ti-Max X25** Ti-Max X25L** Ti-Max X15  <b>Ref.: BVR-388</b> (Ref. NSK®: C601 015 / C601015001)	Ti-Max X15L S-Max M25 * S-Max M25L*  <b>82'80€</b>
	Ti-Max Z45L  <b>Ref.: BVR-385</b> (Ref. NSK®: C1064015)	Eje Ref.: BVE-466 Tapa Ref.: BVT-460  <b>139'80€</b>
	Kit rotor completo + tapa Rodamiento delantero: 3,175 x 6,42 x 1,53mm   Rodamiento trasero: 3,175 x 6,42 x 1,53 mm Ti-Max Z95 Ti-Max Z95L (Modelo antiguo) <b>Ref.: BVR-463</b> (Ref. NSK®: C1034015)	Eje Ref.: BVE-465 Juntas: OR-4061  Nota: Debe cambiarse rotor y tapa, con ello pasaría a ser modelo nuevo  <b>169'80€</b>
	Rodamiento delantero: 3,175 x 6,42 x 1,53mm   Rodamiento trasero: 3,175 x 6,82 x 1,80 mm Ti-Max Z95 Ti-Max Z95L (Modelo nuevo) <b>Ref.: BVR-466</b> (Ref. NSK®: C1034D017)	Eje Ref.: BVE-465 Tapa Ref.: BVT-467 Juntas: OR-4061  <b>158'00€</b>
	FX15 FX25 X23  <b>Ref.: BVR-454</b> (Ref. NSK®: C1052700 / C1056700)	Eje Ref.: BVE-455 Tapa Ref.: BVT-456  <b>58'00€</b>
	TI-MAX Z25 TI-MAX Z25L TI-MAX Z15 TI-MAX Z15L  <b>Ref.: BVR-457</b> (Ref. NSK®: C1038015)	S-MAX M25 * S-MAX M25L * Nano 25LS  <b>84'80€</b>
		Conjunto repuestos cabeza: BVX-7421 Eje Ref. Z25: BVE-458 Eje Ref. M25: BVE-423 (Rotor abierto) Tapa Ref. Z25: BVT-459 Tapa Ref. M25: BVT-419 (Rotor abierto) Juntas: OR-4061 y OR-8060  *Para rotores cerrados ver Ref.: BVR-388

## Modelos para NSK®

## Relacionados



S-Max SG20\*\*  
S-Max SG20L  
Ti-Max X-SG20L\*

Ti-Max X-DSG20L\*\*\*

\*Conjunto repuestos cabeza: BVX-7423  
\*\*Conjunto repuestos cabeza: BVX-7425  
\*\*\* Conjunto repuestos cabeza: BVX-7424  
Eje Ref. S-MAX SG20: BVE-395  
Eje Ref. TI-MAX SG20: BVE-422  
Eje Ref. TI-MAX X-DSG20L: BVE-450  
Tapa Ref.: BVT-391

Incluye: arandela azul y  
arandela metálica

Ref.: **BVR-394** (Ref. NSK®: C1010150002 / C1010150001)

88'00€

## Ejes compatibles contra ángulos NSK®

RUMAR

## Modelos para NSK®

## Relacionados



Ti-Max Ti25  
Ti-Max Ti25L

Ref.: **BVE-396**

48'00€



FPB-Y  
FFB-Y

Ref.: **BVE-400**

48'00€



Ti-Max X95  
Ti-Max X95L

Ref.: **BVE-385** (Ref. NSK®: C600022)

108'00€

Tornillo retenedor: BVX-401



S-Max M95 (Modelo antiguo)  
S-Max M95L (Modelo antiguo)

Ref.: **BVE-386** (Ref. NSK®: 10000559)

118'00€



S-Max M95 (Modelo nuevo)  
S-Max M95L (Modelo nuevo)

Ref.: **BVE-399** (Ref. NSK® C1141022)

118'00€



Ti-Max X25  
Ti-Max X25L

Ref.: **BVE-389** (Ref. NSK®: C601022)

48'00€

Tornillo retenedor: BVX-401









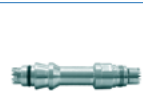
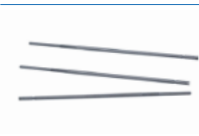

Tornillo retenedor eje contra ángulos  
Ti-Max X95  
Ti-Max X95L











Ti-Max X25  
Ti-Max X25L

Ref.: **BVX-401** (Ref. NSK®: C600242)

11'80€



	Modelos para NSK®	Relacionados
	S-Max M25 (Rotor cerrado)* S-Max M25L (Rotor cerrado)*  <b>Ref.: BVE-390</b> (Ref. NSK®: 1000574)	* Para rotor abierto ver referencia BVE-423  <b>48<sup>00</sup>€</b>
	S-Max M25 (Rotor abierto)* S-Max M25L (Rotor abierto)*  <b>Ref.: BVE-423</b> (Ref. NSK®: C1142022)	* Para rotor cerrado ver referencia BVE-390  <b>89<sup>80</sup>€</b>
	Tornillo retenedor eje contra ángulos S-Max M15 (N/S: A_) S-Max M25L (N/S: A_) S-Max M15L (N/S: A_) S-Max M95 (N/S: C_) S-Max M25 (N/S: A_) S-Max M95L (N/S: C_)  <b>Ref.: BVX-402</b> (Ref. NSK®: C1141242)	  <b>11<sup>80</sup>€</b>
	S-Max SG20 S-Max SG20L  <b>Ref.: BVE-395</b> (Ref. NSK®: C1010022 / 10000229001)	<b>Llave Ref.: HE-950</b>  <b>98<sup>00</sup>€</b>
	Ti-Max X-SG20 Ti-Max X-SG20L  <b>Ref.: BVE-422</b> (Ref. NSK®: C1003022 / 10000255001)	<b>Llave Ref.: HE-950</b>  <b>98<sup>00</sup>€</b>
	Ti-Max X-DSG20L  <b>Ref.: BVE-450</b> (Ref. NSK®: C1068912)	<b>Llave Ref.: HE-950</b>  <b>149<sup>80</sup>€</b>
	FX15 FX25 FX23  <b>Ref.: BVE-455</b> (Ref. NSK®: C10000946)	  <b>54<sup>80</sup>€</b>
	Ti-Max Z45L  <b>Ref.: BVE-466</b> (Ref. NSK®: C1064022)	  <b>118<sup>00</sup>€</b>
	Ti-Max Z25 Ti-Max Z25L  <b>Ref.: BVE-458</b> (Ref. NSK®: C1038022)	  <b>59<sup>80</sup>€</b>
	Ti-Max Z95 Ti-Max Z95L  <b>Ref.: BVE-465</b> (Ref. NSK®: C1034022002)	  <b>149<sup>80</sup>€</b>

## Tapas compatibles contra ángulos NSK®

	Modelos para NSK®		Relacionados
	Ti-Max Ti25 Ti-Max Ti25L Ti-Max X15 Ti-Max X15L	Ti-Max X25 Ti-Max X25L S-Max M25 (Rotor cerrado)* S-Max M25L (Rotor cerrado)*	FPB-Y  Llave Ref.: HE-610 Llave Ref.: HE-613  *Para rotores abiertos ver Ref. BVT-419
	<b>Ref.: BVT-387</b> (Ref. NSK®: C601050)		<b>19'80€</b>
	S-Max M25 (Rotor abierto)* S-Max M25L (Rotor abierto)*		Llave Ref.: HE-762 Llave Doble Ref.: HE-615  *Para rotores cerrados ver Ref. BVT-387
	<b>Ref.: BVT-419</b> (Ref. NSK®: C1142050)		<b>19'80€</b>
	S-Max M95 S-Max M95L Ti-Max X95 Ti-Max X95L		Llave Ref.: HE-762 Llave Doble Ref.: HE-615
	<b>Ref.: BVT-404</b> (Ref. NSK®: C600B050)		<b>22'80€</b>
	MP-Y MP-F MPA-Y	MPAS-Y	Llave Ref.: HE-845
	<b>Ref.: BVT-436</b>		<b>24'80€</b>
	Arandela metálica cabeza: S-Max SG20 S-Max SG20L Ti-Max X-SG20L	Ti-Max X-DSC20L	
	<b>Ref.: BVX-400MD</b> (Ref. NSK®: 20000341)		<b>3'00€</b>
	Arandela goma azul: S-Max SG20 S-Max SG20L Ti-Max X-SG20L	Ti-Max X-DSC20L	
	<b>Ref.: BVX-400RD</b> (Ref. NSK®: C495360A)		<b>3'00€</b>
	S-Max SG20 S-Max SG20L Ti-Max X-SG20L	Ti-Max X-DSC20L	Llave Ref.: HE-616
	<b>Ref.: BVT-391</b> (Ref. NSK®: 10000228)		<b>21'80€</b>
	FX15 FX25 FX23		Llave Ref.: HE-839
	<b>Ref.: BVT-456</b> (Ref. NSK®: C1052500)		<b>19'80€</b>
	Ti-Max Z25 Ti-Max Z25L		
	<b>Ref.: BVT-459</b>		<b>19'80€</b>
	Ti-Max Z45L Ti-Max Z-SG45L		
	<b>Ref.: BVT-460</b> (Ref. NSK®: C1064050)		<b>74'80€</b>

## Modelos para NSK®





## Relacionados

	<p>Ti-Max Z95 (Modelo antiguo) Ti-Max Z95L (Modelo antiguo)</p> <p><b>*Confirmar medida rodamiento trasero*</b></p> <p><b>Ref.: BVT-464</b> (Ref. NSK®: C1038015)</p>	<p>Llave Ref.: HE-615</p> <p><b>19'80€</b></p> <p><b>HASTA AGOTAR</b></p>
	<p>Ti-Max Z95 (Modelo nuevo) Ti-Max Z95L (Modelo nuevo)</p> <p><b>*Confirmar medida rodamiento trasero*</b></p> <p><b>Ref.: BVT-467</b> (Ref. NSK®: C1034050)</p>	<p>Llave Ref.: HE-615</p> <p><b>22'80€</b></p>

## Anillos Tóricos Contra Ángulos y Piezas de Mano NSK®

RUMAR

## Modelos para NSK®

 <p>Imagen no disponible</p>	<p>Retenedor junta cuello contra ángulos NSK®</p> <p>S-Max M25 (Rotor cerrado)      Ti-Max Ti25 S-Max M25L (Rotor cerrado)      Ti-Max Ti25L</p> <p>Ti-Max X25 Ti-Max X25L</p> <p><b>***Original NSK***</b></p> <p><b>Ref.: OR-7062</b> (Ref. NSK®: C387062)</p>	<p>Pack 2 uds.</p> <p><b>8'80€</b></p>																																																												
 <p>Imagen no disponible</p>	<p>Junta cuello contra ángulos NSK®</p> <p>S-Max M25 (Rotor cerrado y rotor abierto)      S-Max M95 S-Max M25L (Rotor cerrado y rotor abierto)      S-Max M95L</p> <p>Ti-Max Ti25 Ti-Max Ti25L</p> <p>Ti-Max X25 Ti-Max X25L Ti-Max X95 Ti-Max X95L</p> <p><b>***Original NSK***</b></p> <p><b>Ref.: OR-7064</b> (Ref. NSK®: C427064)</p>	<p>Pack 2 uds.</p> <p><b>6'80€</b></p>																																																												
 <p>Imagen no disponible</p>	<p>Anillo tórico cuello contra ángulo NSK®</p> <p>Ti-Max Z25      Ti-Max Z95 Ti-Max Z25L      Ti-Max Z95L</p> <p><b>***Original NSK***</b></p> <p><b>Ref.: OR-4061</b> (Ref. NSK®: C1034061)</p>	<p>Pack 2 uds.</p> <p><b>9'80€</b></p>																																																												
 <p>Imagen no disponible</p>	<p>Retenedor anillo tórico cuello contra ángulos NSK:</p> <p>Ti-Max Z25 Ti-Max Z25L</p> <p><b>***Original NSK***</b></p> <p><b>Ref.: OR-8060</b> (Ref. NSK®: C1038060)</p>	<p>Pack 2 uds.</p> <p><b>9'80€</b></p>																																																												
 <p>Imagen no disponible</p>	<p>Anillo tórico contra ángulos NSK:</p> <table border="0"> <tr> <td>EX-ENDO 128</td> <td>S-Max M25</td> <td>Ti-Max Ti12</td> <td>Ti-Max Ti57L</td> </tr> <tr> <td>MP-F</td> <td>S-Max M25L</td> <td>Ti-Max Ti12L</td> <td>Ti-Max Ti70</td> </tr> <tr> <td>MP-Y</td> <td>S-Max M95</td> <td>Ti-Max Ti20</td> <td>Ti-Max Ti70L</td> </tr> <tr> <td>MPA-F10R</td> <td>S-Max M95L</td> <td>Ti-Max Ti20L</td> <td>Ti-Max Ti75</td> </tr> <tr> <td>MPA-F16R</td> <td>S-Max Pico</td> <td>Ti-Max Ti25</td> <td>Ti-Max Ti75L</td> </tr> <tr> <td>MPA-F20R</td> <td>Ti-ENDO</td> <td>Ti-Max Ti25L</td> <td>Ti-Max Ti85</td> </tr> <tr> <td>MPA-F4R</td> <td>Ti-Max AB450L</td> <td>Ti-Max Ti35</td> <td>Ti-Max Ti85LA</td> </tr> <tr> <td>MPA-Y</td> <td>Ti-Max AS500L</td> <td>Ti-Max Ti35L</td> <td>Ti-Max Ti95</td> </tr> <tr> <td>MPAS-F10R</td> <td>Ti-Max AS600L</td> <td>Ti-Max Ti45</td> <td>Ti-Max Ti95EX</td> </tr> <tr> <td>MPAS-F16R</td> <td>Ti-Max AS700L</td> <td>Ti-Max Ti45L</td> <td>Ti-Max Ti95L</td> </tr> <tr> <td>MPAS-F20R</td> <td>Ti-Max AW450L</td> <td>Ti-Max Ti50</td> <td>Ti-Max Ti95LA</td> </tr> <tr> <td>MPAS-F4R</td> <td>Ti-Max Ti-SG20</td> <td>Ti-Max Ti50L</td> <td>Ti-Max X-DSG20</td> </tr> <tr> <td>MPAS-Y</td> <td>Ti-Max Ti-SG20L</td> <td>Ti-Max Ti55</td> <td>Ti-Max Z45L</td> </tr> <tr> <td>S-Max M15</td> <td>Ti-Max Ti10</td> <td>Ti-Max Ti55L</td> <td>Ti-Max Z85L</td> </tr> <tr> <td>S-Max M15L</td> <td>Ti-Max Ti10L</td> <td>Ti-Max Ti57</td> <td>Ti-Max Z95L</td> </tr> </table> <p><b>Y otros</b></p>	EX-ENDO 128	S-Max M25	Ti-Max Ti12	Ti-Max Ti57L	MP-F	S-Max M25L	Ti-Max Ti12L	Ti-Max Ti70	MP-Y	S-Max M95	Ti-Max Ti20	Ti-Max Ti70L	MPA-F10R	S-Max M95L	Ti-Max Ti20L	Ti-Max Ti75	MPA-F16R	S-Max Pico	Ti-Max Ti25	Ti-Max Ti75L	MPA-F20R	Ti-ENDO	Ti-Max Ti25L	Ti-Max Ti85	MPA-F4R	Ti-Max AB450L	Ti-Max Ti35	Ti-Max Ti85LA	MPA-Y	Ti-Max AS500L	Ti-Max Ti35L	Ti-Max Ti95	MPAS-F10R	Ti-Max AS600L	Ti-Max Ti45	Ti-Max Ti95EX	MPAS-F16R	Ti-Max AS700L	Ti-Max Ti45L	Ti-Max Ti95L	MPAS-F20R	Ti-Max AW450L	Ti-Max Ti50	Ti-Max Ti95LA	MPAS-F4R	Ti-Max Ti-SG20	Ti-Max Ti50L	Ti-Max X-DSG20	MPAS-Y	Ti-Max Ti-SG20L	Ti-Max Ti55	Ti-Max Z45L	S-Max M15	Ti-Max Ti10	Ti-Max Ti55L	Ti-Max Z85L	S-Max M15L	Ti-Max Ti10L	Ti-Max Ti57	Ti-Max Z95L	<p><b>5'80€</b></p>
EX-ENDO 128	S-Max M25	Ti-Max Ti12	Ti-Max Ti57L																																																											
MP-F	S-Max M25L	Ti-Max Ti12L	Ti-Max Ti70																																																											
MP-Y	S-Max M95	Ti-Max Ti20	Ti-Max Ti70L																																																											
MPA-F10R	S-Max M95L	Ti-Max Ti20L	Ti-Max Ti75																																																											
MPA-F16R	S-Max Pico	Ti-Max Ti25	Ti-Max Ti75L																																																											
MPA-F20R	Ti-ENDO	Ti-Max Ti25L	Ti-Max Ti85																																																											
MPA-F4R	Ti-Max AB450L	Ti-Max Ti35	Ti-Max Ti85LA																																																											
MPA-Y	Ti-Max AS500L	Ti-Max Ti35L	Ti-Max Ti95																																																											
MPAS-F10R	Ti-Max AS600L	Ti-Max Ti45	Ti-Max Ti95EX																																																											
MPAS-F16R	Ti-Max AS700L	Ti-Max Ti45L	Ti-Max Ti95L																																																											
MPAS-F20R	Ti-Max AW450L	Ti-Max Ti50	Ti-Max Ti95LA																																																											
MPAS-F4R	Ti-Max Ti-SG20	Ti-Max Ti50L	Ti-Max X-DSG20																																																											
MPAS-Y	Ti-Max Ti-SG20L	Ti-Max Ti55	Ti-Max Z45L																																																											
S-Max M15	Ti-Max Ti10	Ti-Max Ti55L	Ti-Max Z85L																																																											
S-Max M15L	Ti-Max Ti10L	Ti-Max Ti57	Ti-Max Z95L																																																											
<p><b>Ref.: OR-5040</b> (Ref. NSK®: 0312065040)</p>	<p><b>5'80€</b></p>																																																													

## Modelos para NSK®

## Relacionados

	<p>Junta contra ángulos NSK:</p> <table border="0"> <tr> <td>S-Max M25</td> <td>S-Max M95L</td> <td>Ti-Max Ti95</td> <td>Ti-Max Ti95LA</td> <td></td> </tr> <tr> <td>S-Max M25L</td> <td>Ti-Max Ti25</td> <td>Ti-Max Ti95EX</td> <td>Ti-Max Z95L</td> <td></td> </tr> <tr> <td>S-Max M95</td> <td>Ti-Max Ti25L</td> <td>Ti-Max Ti95L</td> <td><b>Y otros modelos</b></td> <td></td> </tr> </table> <p><b>Ref.: OR-7063</b> (Ref. NSK®: C427062) <span style="float: right;"><b>1'80€</b></span></p>	S-Max M25	S-Max M95L	Ti-Max Ti95	Ti-Max Ti95LA		S-Max M25L	Ti-Max Ti25	Ti-Max Ti95EX	Ti-Max Z95L		S-Max M95	Ti-Max Ti25L	Ti-Max Ti95L	<b>Y otros modelos</b>		Pack 2 uds.
S-Max M25	S-Max M95L	Ti-Max Ti95	Ti-Max Ti95LA														
S-Max M25L	Ti-Max Ti25	Ti-Max Ti95EX	Ti-Max Z95L														
S-Max M95	Ti-Max Ti25L	Ti-Max Ti95L	<b>Y otros modelos</b>														
 <small>Imagen no disponible</small>	<p>Anillo tórico contra ángulos NSK:</p> <table border="0"> <tr> <td>S-Max M65</td> <td>Ti-Max E65L</td> <td>Ti-Max Ti65L</td> <td>Ti-Max X-SG65</td> <td>Ti-Max X65L</td> </tr> <tr> <td>S-Max M65L</td> <td>Ti-Max E65LJ</td> <td>Ti-Max Ti65LA</td> <td>Ti-Max X-SG65L</td> <td></td> </tr> <tr> <td>Ti-Max E65</td> <td>Ti-Max Ti65</td> <td>Ti-Max Ti65LJ</td> <td>Ti-Max X65</td> <td></td> </tr> </table> <p><b>Ref.: OR-0035</b> (Ref. NSK®: 0312140035) <span style="float: right;"><b>5'80€</b></span></p>	S-Max M65	Ti-Max E65L	Ti-Max Ti65L	Ti-Max X-SG65	Ti-Max X65L	S-Max M65L	Ti-Max E65LJ	Ti-Max Ti65LA	Ti-Max X-SG65L		Ti-Max E65	Ti-Max Ti65	Ti-Max Ti65LJ	Ti-Max X65		
S-Max M65	Ti-Max E65L	Ti-Max Ti65L	Ti-Max X-SG65	Ti-Max X65L													
S-Max M65L	Ti-Max E65LJ	Ti-Max Ti65LA	Ti-Max X-SG65L														
Ti-Max E65	Ti-Max Ti65	Ti-Max Ti65LJ	Ti-Max X65														
 <small>Imagen no disponible</small>	<p>Anillo tórico contra ángulos NSK:</p> <table border="0"> <tr> <td>S-Max M65,</td> <td>Ti-Max E65L</td> <td>Ti-Max Ti65L</td> <td>Ti-Max X-SG65</td> <td>Ti-Max X65L</td> </tr> <tr> <td>S-Max M65L</td> <td>Ti-Max E65LJ</td> <td>Ti-Max Ti65LA</td> <td>Ti-Max X-SG65L</td> <td></td> </tr> <tr> <td>Ti-Max E65</td> <td>Ti-Max Ti65</td> <td>Ti-Max Ti65LJ</td> <td>Ti-Max X65</td> <td></td> </tr> </table> <p><b>Ref.: OR-4035</b> (Ref. NSK®: 0312154035) <span style="float: right;"><b>5'80€</b></span></p>	S-Max M65,	Ti-Max E65L	Ti-Max Ti65L	Ti-Max X-SG65	Ti-Max X65L	S-Max M65L	Ti-Max E65LJ	Ti-Max Ti65LA	Ti-Max X-SG65L		Ti-Max E65	Ti-Max Ti65	Ti-Max Ti65LJ	Ti-Max X65		
S-Max M65,	Ti-Max E65L	Ti-Max Ti65L	Ti-Max X-SG65	Ti-Max X65L													
S-Max M65L	Ti-Max E65LJ	Ti-Max Ti65LA	Ti-Max X-SG65L														
Ti-Max E65	Ti-Max Ti65	Ti-Max Ti65LJ	Ti-Max X65														

## Repuestos compatibles Piezas de Mano NSK®

RUMAR

## Modelos para NSK®

## Relacionados

	<p>Pinza para pieza de mano recta NSK®</p> <table border="0"> <tr> <td>S-Max M65</td> <td>Ti-Max E65LJ</td> <td>Ti-Max Ti65LJ</td> <td>Ti-Max X65L</td> </tr> <tr> <td>S-Max M65L</td> <td>Ti-Max Ti65</td> <td>Ti-Max X-SG65</td> <td></td> </tr> <tr> <td>Ti-Max E65</td> <td>Ti-Max Ti65L</td> <td>Ti-Max X-SG65L</td> <td></td> </tr> <tr> <td>Ti-Max E65L</td> <td>Ti-Max Ti65LA</td> <td>Ti-Max X65</td> <td></td> </tr> </table> <p><b>Ref.: BVX-374</b> (Ref. NSK®: H190280 / H190A180A) <span style="float: right;"><b>12'80€</b></span></p>	S-Max M65	Ti-Max E65LJ	Ti-Max Ti65LJ	Ti-Max X65L	S-Max M65L	Ti-Max Ti65	Ti-Max X-SG65		Ti-Max E65	Ti-Max Ti65L	Ti-Max X-SG65L		Ti-Max E65L	Ti-Max Ti65LA	Ti-Max X65		
S-Max M65	Ti-Max E65LJ	Ti-Max Ti65LJ	Ti-Max X65L															
S-Max M65L	Ti-Max Ti65	Ti-Max X-SG65																
Ti-Max E65	Ti-Max Ti65L	Ti-Max X-SG65L																
Ti-Max E65L	Ti-Max Ti65LA	Ti-Max X65																

# REPUESTOS PARA CONTRA ÁNGULOS Y PIEZAS DE MANO W&H®







## Rotores compatibles destacados contra ángulos W&H®











RUMAR

Modelos para W&H®	Relacionados
 <p>Conjunto repuestos cabeza (Rotor completo + carcasa + botón + eje + tornillo + muelle) WS-75 LED G (Modelo antiguo)</p> <p><b>Ref.: BVX-7440</b> (Ref. W&amp;H®: 07220701+04939900+04940500+06025100)</p>	<p>BVR-399 BVE-378 BVT-376</p> <p><b>348<sup>00</sup>€</b></p>

## Rotores compatibles contra ángulos W&H®

RUMAR

Modelos para W&H®	Relacionados
 <p>WS-75 LED G **      WS-75 LG ****      WI-75 LED G * WS-75 E ***      WI-75 E * WS-75 KM ***      WI-75 KM * <b>(Confirmar con imagen)</b></p> <p><b>Ref.: BVR-399</b> (Ref. W&amp;H®: 04939900)</p>	<p>***Conjunto repuestos cabeza: BVX-7440 *Eje Ref.: BVE-381 **Eje Ref.: BVE-378 ***Eje Ref.: BVE-415 (Rev. N/S&lt;25.335) ***Eje Ref.: BVE-416 (Rev. N/S&gt;30.000) ****Eje Ref.: BVE-726 Tapa Ref.: BVT-376</p> <p><b>128<sup>00</sup>€</b></p>
 <p>WS-75 E (01001 &lt; N/S &lt; 25335) WS-75 KM (01001 &lt; N/S &lt; 25335) <b>(Confirmar con imagen)</b></p> <p><b>Ref.: BVR-453</b> (Ref. W&amp;H®: 04651800)</p>	<p>***Necesario cambiar eje y tapa, contra ángulo antiguo***</p> <p>Eje Ref.: BVE-415 Tapa Ref.: BVT-376</p> <p><b>108<sup>00</sup>€</b></p>
 <p>Alegra® WE-56 Alegra® WE-56E Synea® WA-56A (antiguo)</p> <p><b>Ref.: BVR-370</b> (Ref. W&amp;H®: 03819000, 05843300)</p>	<p>Rodamientos: 2mm</p> <p>Eje Ref.: BVE-374 Tapa Ref.: BVT-379</p> <p><b>68<sup>80</sup>€</b></p>
 <p>Alegra® WE-56 LED G Alegra® WE-56A</p> <p><b>Ref.: BVR-443</b> (Ref. W&amp;H®: 05844400)</p>	<p>Tapa Ref.: BVT-379</p> <p><b>74<sup>80</sup>€</b></p>
 <p>Piñón para: Alegra® WE-56 Alegra® WE-56E Alegra® WA-56A (antiguo)</p> <p><b>Ref.: BVR-371</b></p>	<p><b>39<sup>80</sup>€</b></p>
 <p>Alegra® WE-56 Alegra® WE-56LT</p> <p><b>Ref.: BVR-477</b> (Ref. W&amp;H®: 07539000)</p>	<p><b>158<sup>00</sup>€</b></p>
 <p>Alegra® WE-99A Alegra® WE-99 LED G</p> <p><b>Ref.: BVR-478</b> (Ref. W&amp;H®: 05846100)</p>	<p>Eje Ref.: BVE-443 Tapa Ref.: BVT-474</p> <p><b>148<sup>00</sup>€</b></p>

Modelos para W&H®		Relacionados
	Synea® WA-56 (desde 2007) Synea® WA-56LT (desde 2007) Synea® WA-66 (desde 2007) Synea® WA-66A (desde 2007) Synea® WA-66LT (desde 2007)  <b>Ref.: BVR-375</b> (Ref. W&H®: 05431100)	Synea®® Vision WK-56 (N/S<04013) Synea®® Vision WK-66 (N/S<01906)  <b>68<sup>80</sup>€</b>
	Synea® WA-99LT (desde 2007)  <b>Ref.: BVR-427</b> (Ref. W&H®: 05220300)	<b>Rodamientos: 1,6mm</b>  Eje Ref.: BVE-439 Tapa Ref.: BVT-377  <b>223<sup>80</sup>€</b>
	Fusion WG-99LT (SN > 007802) Vision WK-99LT (SN > 01001)  <b>Ref.: BVR-442</b> (Ref. W&H®: 07473400)	Eje Ref. <b>WG-99LT: 44-440</b> Eje Ref. <b>WK-99: 44-441</b>  <b>108<sup>00</sup>€</b>
	Rotor completo y tapa botón para: Trend WD-56  <b>Ref.: BVR-426</b> (Ref. W&H®: 03425000)	Eje Ref.: BVE-425 Tapa Ref.: BVT-412  <b>80<sup>00</sup>€</b>
	Synea® WA-99LT (hasta 2007) Synea® WA-99A (hasta 2009)  <b>Ref.: BVR-479</b> (Ref. W&H®: 04517200)	Eje Ref.: BVE-438  <b>298<sup>00</sup>€</b>
	Fusion WG-56LT (N/S<014633)  <b>Ref.: BVR-481</b> (Ref. W&H®: 06994300)	Eje Ref.: BVE-439 Tapa Ref.: BVT-377  <b>178<sup>00</sup>€</b>
	Fusion WG-56LT (N/S<014634) Fusion WG-56A (N/S<002462)  <b>Ref.: BVR-480</b> (Ref. W&H®: 07605900)	Eje Ref.: BVE-486 Tapa Ref.: BVT-377  <b>88<sup>00</sup>€</b>
	Fusion WG-99LT (N/S<007801) Fusion WG-99 LED C (N/S<007801) Fusion WG-99A (N/S<001818)  <b>Ref.: BVR-482</b> (Ref. W&H®: 06993900)	  <b>258<sup>00</sup>€</b>
	Vision WK-93LT  <b>Ref.: BVR-485</b> (Ref. W&H®: 07107900)	Eje Ref.: BVE-447  <b>281<sup>80</sup>€</b>
	WS-91 WS-91L WS-91LG  WS-92* WS-92L*  <b>Ref.: BVR-484</b> (Ref. W&H®: 07139200)	* Eje Ref.: BVE-487 Tapa Ref.: BVT-477  <b>281<sup>80</sup>€</b>

BAJO PEDIDO

BAJO PEDIDO

BAJO PEDIDO

BAJO PEDIDO

## Modelos para W&amp;H®

## Relacionados

 <p>Imagen no disponible</p>	<p>WS-56L WS-56L G</p> <p><b>***Original W&amp;H***</b></p> <p><b>Ref.: BVR-486</b> (Ref. W&amp;H®: 06905300)</p>	<p>Eje Ref.: BVE-488 Tapa Ref.: BVT-478</p> <p><b>239<sup>´</sup>80,€</b></p> <p><b>BAJO PEDIDO</b></p>
---	---	---

## Ejes compatibles contra ángulos W&amp;H®

RUMAR

## Modelos para W&amp;H®

## Relacionados

	<p>WS-75 E (N/S &lt; 25.335) WS-75 KM (N/S &lt; 25.335) *modelo fabricado hasta 2008</p> <p><b>Ref.: BVE-415</b> (Ref. W&amp;H®: 04016900)</p>	<p><b>(Eje montaje atornillable)</b></p> <p>Llave Ref.: HE-950</p> <p><b>108<sup>´</sup>00,€</b></p>
--	--	--

NUEVO

 <p>Imagen no disponible</p>	<p>WS-75 E (N/S &gt; 30.000) WS-75 KM (N/S &gt; 30.000)</p> <p><b>***Original W&amp;H***</b></p> <p><b>Ref.: BVE-416</b> (Ref. W&amp;H®: 04948000)</p>	<p><b>315<sup>´</sup>80,€</b></p> <p><b>BAJO PEDIDO</b></p>
---	--	---

 <p><b>(Confirmar con imagen)</b></p>	<p>WI-75 LED G      WI-75 E      WI-75 KM</p> <p><b>Ref.: BVE-381</b> (Ref. W&amp;H®: 04667600)</p>	<p><b>(Eje montaje atornillable)</b></p> <p>Llave Ref.: HE-950</p> <p><b>108<sup>´</sup>00,€</b></p>
---	---	--











	<p>WS-75 LED G*</p> <p>* Modelo fabricado hasta 03/2012</p> <p><b>Ref.: BVE-378</b> (Ref. W&amp;H®: 06025100)</p>	<p><b>(Eje montaje NO atornillable)</b></p> <p><b>108<sup>´</sup>00,€</b></p>
--	---	---

 <p>Imagen no disponible</p>	<p>WS-75 WS-75 LG</p> <p><b>***Original W&amp;H***</b></p> <p><b>Ref.: BVE-726</b> (Ref. W&amp;H®: 06906300)</p>	<p><b>(Eje montaje NO atornillable)</b></p> <p><b>208<sup>´</sup>00,€</b></p>
---	--	---

	<p>Alegria® WE-56 Alegria® WE-56E</p> <p><b>Ref.: BVE-374</b> (Ref. W&amp;H®: 05852500)</p>	<p><b>59<sup>´</sup>80,€</b></p>
--	---	----------------------------------

	<p>Corona inferior para eje: Alegria® WE-56 Alegria® WE-56E</p> <p><b>Ref.: BVE-383</b></p>	<p><b>10<sup>´</sup>80,€</b></p> <p><b>HASTA AGOTAR</b></p>
--	---	---







	<p>Synea® WA-56A (desde 2007 / nuevo) Synea® WA-56LT (desde 2007 / nuevo) Fusion WG-56LT (N/S 001001-014633)</p> <p><b>Ref.: BVE-439</b> (Ref. W&amp;H®: 05233200)</p>	<p><b>138<sup>´</sup>00,€</b></p>
--	--	-----------------------------------

	Modelos para W&H®	Relacionados
	Fusion® WG-56LT (N/S > 014634) Vision® WK-56LT (N/S > 04014) Vision® WK-56S  <b>Ref.: BVE-486</b> (Ref. W&H®: 06796000)	<b>88<sup>00</sup>€</b>
	Trend WD-56  <b>Ref.: BVE-425</b> (Ref. W&H®: 03403500)	<b>48<sup>00</sup>€</b> <b>Llave Ref.: HE-950</b>
	WA-99A (hasta 2007)* WA-99LT (hasta 2007)*  <b>Ref.: BVE-438</b> (Ref. W&H®: 03816000)	* Contra ángulos con 2 anillos rojos y triple spray <b>206<sup>80</sup>€</b> <b>BAJO PEDIDO</b>
	Synea® WA-99LT (desde 2007) Fusion WG-99LT (N/S 001001-007801) Fusion WG-99A (N/S 001001-001818)  <b>Ref.: BVE-440</b> (Ref. W&H®: 06420900)	<b>198<sup>00</sup>€</b> <b>BAJO PEDIDO</b>
	Fusion WG-99LT (SN > 007802) Vision WK-99LT (SN > 01001)  <b>Ref.: BVE-441</b> (Ref. W&H®: 06579200)	<b>205<sup>80</sup>€</b> <b>BAJO PEDIDO</b>
	Alegra® WE-56 Alegra® WE-56T  <b>Ref.: BVE-442</b> (Ref. W&H®: 07250900)	Piezas de mano SIN anillo azul <b>116<sup>80</sup>€</b>
	Alegra® WE-99A Alegra® WE-99 LED G Fusion® WG-99LT (N/S < 007801) Fusion® WG-99 LED G (N/S < 007801)  <b>Ref.: BVE-443</b> (Ref. W&H®: 05845500)	<b>176<sup>80</sup>€</b>
	Synea® WA-66LT (desde 2007)  <b>Ref.: BVE-445</b> (Ref. W&H®: 05273000)	<b>161<sup>80</sup>€</b>
	Alegra® WE-56 LED Alegra® WE-56A  <b>Ref.: BVE-446</b> (Ref. W&H®: 05844300)	<b>121<sup>80</sup>€</b>
	Vision WK-93 LT  <b>Ref.: BVE-447</b> (Ref. W&H®: 06455700)	<b>202<sup>80</sup>€</b> <b>BAJO PEDIDO</b>

	Modelos para W&H®	Relacionados
 <small>Imagen no disponible</small>	WS-92 WS-92L WS-92L G  <b>***Original W&amp;H***</b>  <b>Ref.: BVE-487</b> (Ref. W&H®: 07000001)	248 <sup>100</sup> €  <b>BAJO PEDIDO</b>
 <small>Imagen no disponible</small>	WS-56L WS-56L G  <b>***Original W&amp;H***</b>  <b>Ref.: BVE-488</b> (Ref. W&H®: 06906500)	229 <sup>80</sup> €  <b>BAJO PEDIDO</b>





### Tapas compatibles contra ángulos W&H®

RUMAR

	Modelos para W&H®	Relacionados
	WS-75 WS-75E WS-75KM WS-75E (N/S>30000)  WS-75KM (N/S>30000) WI-75E (N/S>01001) WI-75KM (N/S>01001) WI-75 LED G (N/S>01001)	WS-75 LED G (N/S DE 01001 a 25335)  (modelos fabricados hasta 2008)  <b>Llave: HE-844</b>  <b>Ref.: BVT-376</b> (Ref. W&H®: 04940500)
	Alegra® WE-56 (hasta 2007)* Alegra® WE-56A (hasta 2007)* Alegra® WE-56E (hasta 2007)  <b>*Contra ángulo sin anillo azul</b>	Alegra® WE-56 LED G (hasta 2008) Synea® WA-56A (antiguo rodamientos 2mm)  <b>Llave: HE-763</b>  <b>Ref.: BVT-379</b> (Ref. W&H®: 05843800)
	Synea® WA-56A (desde 2007)* Synea® WA-56LT (desde 2007)* Synea® WA-66LT (desde 2007)**  <b>*Contra ángulo con anillo azul</b>	Fusion WG-56LT (N/S<014633 y N/S>014633) Fusion WG-56A (N/S>002462)  Vision WK-56 (N/S<04013) Vision WK-56 LT (N/S>04014)  <b>**Contra ángulo con anillo verde</b>  <b>Llave: HE-623</b>  <b>Ref.: BVT-377</b> (Ref. W&H®: 05112800 + 03819600 + 04952800 + 05280400)
	Alegra® WE-56 (desde 2008) Alegra® WE-56T (desde 2008) Alegra® WE-56 LED G (desde 2008)	<b>Llave Ref.: HE-763</b>  <b>Ref.: BVT-472</b> (Ref. W&H®: 06993800)
	Trend WD-56	<b>Llave: HE-842</b>  <b>Ref.: BVT-412</b>
	Synea® WA-99A (desde 2007) Synea® WA-99LT (desde 2007)	<b>Llave Ref.: HE-820</b>  <b>Ref.: BVT-413</b> (Ref. W&H®: 07771800 + 07771700 + 04952800)
	Synea® WA-56LT (hasta 2007)	<b>Llave: HE-842</b>  <b>Ref.: BVT-473</b> (Ref. W&H®: 05345200)

## Modelos para W&amp;H®

## Relacionados

	Alegra® WE-99A Alegra® WE-99 LED G Fusion WG-99LT (N/S <007801)	Fusion WG-99 LED G (N/S <007801)	Llave Ref.: HE-763
	<b>Ref.: BVT-474</b> (Ref. W&H®: 05846000)	<b>29<sup>80</sup>€</b>	
	Synea® WA-99A Synea® WA-99A LED (Hasta 2007)		Llave Ref.: HE-842
	<b>Ref.: BVT-475</b> (Ref. W&H®: 04943000)	<b>80<sup>00</sup>€</b>	
	Fusion WG-99LT (N/S >007802) Visio WK-99LT (N/S >01001) Fusion WG-99A (N/S >001819)		Llave Ref.: HE-763
	<b>Ref.: BVT-476</b>	<b>56<sup>80</sup>€</b>	
 <small>Imagen no disponible</small>	WS-91 WS-91L WS-91L G	WS-92 WS-92L	
	<b>***Original W&amp;H®***</b> <b>Ref.: BVT-477</b> (Ref. W&H®: 04026300)	<b>72<sup>80</sup>€</b>	<b>BAJO PEDIDO</b>
 <small>Imagen no disponible</small>	WS-56 WS-56L G		
	<b>***Original W&amp;H®***</b> <b>Ref.: BVT-478</b> (Ref. W&H®: 04033000)	<b>72<sup>80</sup>€</b>	<b>BAJO PEDIDO</b>

## Resto repuestos compatibles contra ángulos W&amp;H®









RUMAR

	Descripción	Observaciones	
	Chaveta para W&H.  <b>Ref.: BVX-372</b> (Ref. W&H® 03819300)	<b>12<sup>80</sup>€</b>	
	Anillo conducción para W&H.  <b>Ref.: BVX-373</b> (Ref. W&H® 03819200)	<b>1<sup>40</sup>€</b>	
	Clip negro aguja de irrigación <b>***Original W&amp;H®***</b> WI-75 WI-75 E/KM	WI-75 LED G WS- 75 E/KM (N/S > 030000)	WS-75 LED G
	<b>Ref.: BVX-39149</b> (Ref. W&H® 04757100 / 3)	<b>31<sup>80</sup>€</b>	<b>Pack: 1 ud.</b>
	Clip verde aguja de irrigación <b>***Original W&amp;H®***</b> WS-75 WS-75 L G		<b>Pack: 1 ud.</b>
	<b>Ref.: BVX-6300</b> (Ref. W&H® 06946300)	<b>31<sup>80</sup>€</b>	







# REPUESTOS PARA CONTRA ÁNGULOS Y PIEZAS DE MANO BIEN AIR®

Rotores compatibles contra ángulos Bien Air®







RUMAR

	Modelos para Bien Air®	Relacionados
	1:5 1:5L  <b>Ref.: BVR-438</b> (Ref. Bien Air®: 1501933)	<b>Incluye:</b> arandela metal + 2 anillos tóricos  <b>Eje Ref.:</b> BVE-437 <b>Tapa Ref.:</b> BVT-445  <b>128<sup>00</sup>€</b>
 <small>Imagen no disponible</small>	EVO15 1:5 L (N/S<19C0121) EVO15 1:5 L MS (N/S<19C0121)  <b>Ref.: BVR-435</b> (Ref. Bien Air®: 1502161)	<b>Eje Ref.:</b> BVE-456 <b>Tapa Ref.:</b> BVT-486  <b>254<sup>80</sup>€</b> <b>BAJO PEDIDO</b>
 <small>Imagen no disponible</small>	EVO15 1:5 L (N/S>19C0121) EVO15 1:5 L MS (N/S>19C0121)  <b>Ref.: BVR-436</b> (Ref. Bien Air®: 1502645)	<b>Eje Ref.:</b> BVE-456 <b>Tapa Ref.:</b> BVT-486  <b>244<sup>80</sup>€</b> <b>BAJO PEDIDO</b>
 <small>Imagen no disponible</small>	NOVA 1:1 L NOVA 1:1 L MS  <b>Ref.: BVR-437</b> (Ref. Bien Air®: 1502641)	<b>Eje Ref.:</b> BVE-457  <b>364<sup>80</sup>€</b> <b>BAJO PEDIDO</b>
	1:1 1:1L  <b>Ref.: BVR-377B</b> (Ref. Bien Air®: 1501085)	<b>Eje Ref.:</b> BVE--378B <b>Tapa Ref.:</b> BVT-0550  <b>98<sup>00</sup>€</b>
 <small>Imagen no disponible</small>	EVO15 1:1 L EVO15 1:1 L MS  <b>Ref.: BVR-429</b> (Ref. Bien Air®: 1502160)	<b>Eje Ref.:</b> BVE-453  <b>294<sup>80</sup>€</b> <b>BAJO PEDIDO</b>
 <small>Imagen no disponible</small>	NOVA 1:1 L NOVA 1:1 L MS  <b>Ref.: BVR-430</b> (Ref. Bien Air®: 1503014)	<b>Eje Ref.:</b> BVE-454  <b>138<sup>00</sup>€</b>
	20:1 20:1L  <b>Ref.: BVR-428</b>	<b>Eje Ref.:</b> BVE-429 <b>Tapa Ref.:</b> BVT-430  <b>98<sup>00</sup>€</b>

Ejes compatibles contra ángulos **Bien Air®**

	Modelos para Bien Air®	Relacionados
	1:5 1:5L  <b>Ref.: BVE-437</b> (Ref. Bien Air®: 1500057)	<b>149<sup>80</sup>€</b>
 <small>Imagen no disponible</small>	EVO151:5 L EVO151:5 L MS  <b>Ref.: BVE-456</b> (Ref. Bien Air®: 1502110)	<b>333<sup>80</sup>€</b> <b>BAJO PEDIDO</b>
 <small>Imagen no disponible</small>	NOVA 1:5 NOVA 1:5L MS  <b>Ref.: BVE-457</b> (Ref. Bien Air®: 1503065)	<b>264<sup>80</sup>€</b> <b>BAJO PEDIDO</b>
	1:1  <b>Ref.: BVE-378B</b> (Ref. Bien Air®: 1500289)	<b>68<sup>00</sup>€</b>
 <small>Imagen no disponible</small>	EVO151:5 L EVO151:5 L MS  <b>Ref.: BVE-453</b> (Ref. Bien Air®: 1502107)	<b>294<sup>80</sup>€</b> <b>BAJO PEDIDO</b>
 <small>Imagen no disponible</small>	NOVA 1:1L NOVA 1:1L MS  <b>Ref.: BVE-454</b> (Ref. Bien Air®: 1502889)	<b>392<sup>80</sup>€</b> <b>BAJO PEDIDO</b>
	20:1 20:1L  <b>Ref.: BVE-429</b>	<b>88<sup>00</sup>€</b>

Tapas compatibles contra ángulos **Bien Air®**



Modelos para Bien Air®		Relacionados
	1:1 1:1 L  <b>Ref.: BVT-0550</b> (Ref. Bien Air®: 1500550)	Llave: HE-849  <b>29<sup>80</sup>€</b>
	1:5 1:5L  <b>Ref.: BVT-445</b> (Ref. Bien Air®: 1500169)	Llave: HE-849  <b>24<sup>80</sup>€</b>
	20:1 20:1L  <b>Ref.: BVT-430</b> (Ref. Bien Air®: 1501027)	Llave: HE-849  <b>29<sup>80</sup>€</b>
	EVO15 1:5 L EVO15 1:5 L MS <b>***Original Bien Air®***</b>  <b>Ref.: BVT-486</b> (Ref. Bien Air®: 1502698)	<b>74<sup>80</sup>€</b>  <b>BAJO PEDIDO</b>
	NOVA 1:1L NOVA 1:1L MS  <b>Ref.: BVT-479</b> (Ref. Bien Air®: 1502817 (1307020+1306822)+1307442)	<b>59<sup>80</sup>€</b>
 <small>Imagen no disponible</small>	NOVA 1:5L NOVA 1:5L MS  <b>Ref.: BVT-480</b> (Ref. Bien Air®: 1502919 (1503064+1307449)+1308388)	<b>59<sup>80</sup>€</b>  <b>BAJO PEDIDO</b>

# REPUESTOS PARA CONTRA ÁNGULOS Y PIEZAS DE MANO SIRONA®

Rotores compatibles contra ángulos Sirona®





RUMAR

Modelos para Sirona®			Relacionados
	T1 Line C200 (N/S>30 000) T1 Line C200L (N/S>43 000 / N/S>65 000) T1 Classic S200L (N/S≤32 001)	T2 Line A200L (N/S<7804 / N/S>7805) T2 Line A170L T3 Line E20 (N/S<2325 / N/S>2326) T3 Line E200L (N/S<2325 / N/S>2326)	T2 Line A200 (N/S<7804   N/S>7805) A200L (N/S≤32 001) A170L T3 Line E200 (N/S<2325 / N/S>2326)  <b>Cabeza standard</b> Rodamientos: 3,175x7x2mm  Eje Ref.: BVE-451 Tapa Ref.: BVT-407
<b>Ref.: BVR-375S</b> (Ref. Sirona®: 6175587 / 6405687)		<b>228<sup>00</sup>€</b>	
	T1 Classic S200L mini (3 000≤N/S≤30 000) T1 Line C200 mini (N/S>30 000) T1 Line C200L mini (43 000≤N/S≤65 000)		<b>Cabeza mini</b>  Eje Ref.: BVE-451 Tapa Ref.: BVT-410
<b>Ref.: BVR-378</b> (Ref. Sirona®: 6175611 / 6049345)		<b>268<sup>00</sup>€</b>	
	T1 Line C40 T1 Line C40L T2 Line A40 T2 Line A40L	T3 Line E40 T1 Classic S40	<b>Cabeza standard</b>  Eje Ref.: BVE-418 Tapa A40 Ref.: BVT-409 Tapa C40 Ref.: BVT-408
<b>Ref.: BVR-417</b> (Ref. Sirona®: 6000983)		<b>88<sup>00</sup>€</b>	
	T1 Classic S200L (N/S>32 002) T1 Classic S200L (N/S>202 000) T1 Line C200L (N/S>68 381) T1 Line C200L (N/S<302 000 y N/S>202 000)	T2 Line A200L (N/S>202 000 y N/S<302 000) T3 Line E200 (N/S>202 000) T3 S-Line ES200 T2 S-Line AS200L	<b>Cabeza standard</b>  Rodamientos: 3,175x6x2mm  Eje Ref.: BVE-451 Tapa Ref.: BVT-410
<b>Ref.: BVR-444</b> (Ref. Sirona®: 6414457 / 6562586)		<b>138<sup>00</sup>€</b>	
	T1 Classic S200L mini (N/S>30 000) T1 Line C200L mini (N/S>65 000)		<b>Cabeza mini</b>  Eje Ref.: BVE-451 Tapa Ref.: BVT-410
<b>Ref.: BVR-445</b> (Ref. Sirona®: 6405679)		<b>244<sup>80</sup>€</b>	
	Dentsply X-Smart Plus 6:1		Eje Ref.: BVE-432 Tapa Ref.: BVT-433
<b>Ref.: BVR-431</b>		<b>88<sup>00</sup>€</b>	
	Dentsply X-Smart 16:1		Eje Ref.: BVE-435 Tapa Ref.: BVT-436
<b>Ref.: BVR-434</b>		<b>68<sup>80</sup>€</b>	
	T2 Revo Mini R40 T2 S-Line AS40L T3 S-Line ES40 T3 Line E40 (SN>202 000) cabeza mini	T2 Line A40 (SN>202 000) T1 Classic S40L (SN>30 000 & >202 000) T1 Line C40L (SN>65 000 & >202 000)	T1 Line C40/C40L 1:1 8,7 cabeza mini  Rodamiento trasero: 4x7x1,6mm  Eje R40 Ref.: BVE-421 Eje A40 Ref.: BVE-418 Eje C40 mini Ref.: BVE-418 Eje E40 mini Ref.: BVE-418 Tapa Ref.: BVT-411
<b>Ref.: BVR-416</b> (Ref. Sirona®: 6049352 / 6405695)		<b>98<sup>00</sup>€</b>	
	T2 Revo Mini R40 T2 S-Line AS40L T3 S-Line ES40 T3 Line E40 (SN>202 000) cabeza mini	T2 Line A40 (SN>202 000) T1 Classic S40L (SN>30 000 & >202 000) T1 Line C40L (SN>65 000 & >202 000)	T1 Line C40/C40L 1:1 8,7 cabeza mini  Rodamiento trasero: 4x7x2mm  Eje R40 Ref.: BVE-421 Eje A40 Ref.: BVE-418 Eje C40 mini Ref.: BVE-418 Eje E40 mini Ref.: BVE-418 Tapa Ref.: BVT-411
<b>Ref.: BVR-452</b> (Ref. Sirona®: 5943092 / 6049352)		<b>98<sup>00</sup>€</b>	

Modelos para Sirona®		Descripción
	T1 Line Endo 6L	Eje Ref.: BVE-470 Tapa Ref.: BVT-471
<b>Ref.: BVR-469</b>	(Ref. Sirona®: 6535525 / 6000777)	<b>84´80€</b>
	T1 CLASSIC S6L (N/S>30.000 y N/S>202.000) T1 CLASSIC S1,6L (N/S>30.000 y N/S>202.000) T1 LINE C6L (N/S>65.000 y N/S>202.000)	T1 LINE C1,6L (N/S>65.000 y N/S>202.000) T1 LINE C6 / C6L (cabeza 6:1) T1 LINE C1,6 / C1,6L (cabeza 6:1)
<b>Ref.: BVR-470</b>	(Ref. Sirona®: 6405703)	Eje Ref.: BVE-452 <b>149´80€</b>



## Ejes compatibles contra ángulos Sirona®

RUMAR

Modelos para Sirona®		Relacionados
	T1 CLASSIC S200L mini T1 LINE C200L mini N/S > 65 000 / N/S > 43 000 T1 LINE C200 mini N/S > 30 000 T2 LINE A200L N/S < 7804 / N/S > 7805 T3 LINE E200 N/S < 2325 / N/S > 2326 T1 LINE C200 N/S > 30 000 T1 LINE C200 N/S > 43 000 y N/S > 65 00	T1 CLASSIC S200L N/S ≤ 32 001 T1 CLASSIC S200L N/S > 32 002 T1 CLASSIC S200L N/S > 202 000 T1 LINE C200L N/S > 68 381 T1 LINE C200L N/S > 202 000 y N/S < 302 000 T2 LINE A200L N/S > 202 000 y N/S < 302 000
<b>Ref.: BVE-451</b>	(Ref. Sirona®: 6175603)	T2 S-line AS 200 L T3 S-line ES 200 T3 line E200 N/S > 202 000 T2 line A200 L N/S > 302 000 <b>149´80€</b>
	T1 Classic S40 T1 Line C40 (Cabeza mini y standard) T1 Line C40L (Cabeza mini y standard)	T2 Line A40 T2 Line A40L T3 Line E40 (Cabeza mini y standard)
<b>Ref.: BVE-418</b>	(Ref. Sirona®: 6000959)	<b>68´00€</b>
	T1 CLASSIC KM 1,6L N/S > 30.000 T1 CLASSIC S 1,6L N/S > 30.000 y N/S > 202.000 T1 CLASSIC S 6L N/S > 30.000 y N/S > 202.000 T1 LINE C1,6 (cabeza 6:1) T1 LINE C1,6C (cabeza 1:1 ADA) T1 LINE C1,6L (cabeza 1:1 ADA) T1 LINE C1,6L N/S > 65.000 y N/S > 202.000 T1 LINE C1,6L (cabeza 6:1) T1 LINE C6 (cabeza 6:1)	T1 LINE C6 (cabeza 1:1 ADA) T1 LINE C6L (cabeza 6:1) T1 LINE C6L (cabeza 1:1 ADA) T1 LINE C6L N/S > 65.000 y N/S > 202.000 T1 LINE KM 1,6 T1 LINE KM 1,6L T2 LINE A 6L T2 LINE A 6L N/S > 202.000 T2 S-LINE AS 6L T3 LINE E6
<b>Ref.: BVE-452</b>	(Ref. Sirona®: 6000942 / 3327884)	T3 S-LINE ES 6 SIROPure P6 IL (cabeza 6:1 / 6:1 ADA) SIROPure P6 IL mini SIROPure P6 SL (cabeza 6:1 / 6:1 ADA) SIROPure P6 SL mini SIROPure T3 LINE E 6 N/S > 202.000 <b>228´00€</b>
	T2 Revo R40	
<b>Ref.: BVE-421</b>	(Ref. Sirona®: 5943167)	<b>68´00€</b>
	Dentsply X-Smart Plus 6:1	
<b>Ref.: BVE-432</b>		<b>78´00€</b>

## Modelos para Sirona®

## Relacionados







	Dentsply X-Smart 16:1  <b>Ref.: BVE-435</b>	<b>68<sup>00</sup>€</b>	
	T1 Line ENDO 6L  <b>Ref.: BVE-470</b> (Ref. Sirona®: 6535533)	<b>68<sup>00</sup>€</b>	

## Tapas compatibles contra ángulos Sirona®

RUMAR



## Modelos para Sirona®

## Relacionados

	T1 Classic S200L (SN≤32 001) T1 Line C200L (SN>43 000 & >65 000) T1 Line C200 (SN>30 000)	T3 Line E200L T2 Line A200L (SN<7804 & >7805) T2 Line A170L	T3 Line E200 (SN<2325 & >2326) SIROPure P200SL SIROPure P200IL	<b>Llave Ref.: HE-818</b>
<b>Ref.: BVT-407</b> (Ref. Sirona®: 8925083 + 5996967 + 5947957)			<b>24<sup>80</sup>€</b>	
	T2 Line A40L T2 Line A6L T3 Line E40	T3 Line E6 SIROPure P40SL (ADA) SIROPure P40IL (ADA)	SIROPure P6SL (ADA) SIROPure P6SIL (ADA)	<b>Llave Ref.: HE-818</b>
<b>Ref.: BVT-409</b> (Ref. Sirona®: 8925083 + 8917924 + 5947957)			<b>56<sup>80</sup>€</b>	
	T1 Classic S40L T1 Classic S6L T1 Line C40 (ADA) T1 Line C40L (ADA)	T1 Line C6 T1 Line C6L T1 Line C1.6 T1 Line C1.6L	Siropure P40SL Siropure P40IL Siropure P6SL Siropure P6IL	<b>Llave Ref.: HE-818</b>
<b>Ref.: BVT-408</b> (Ref. Sirona®: 8925083 + 6259639 + 5947957)			<b>24<sup>80</sup>€</b>	
	T1 Classic S200L (SN≥32 002) T1 Classic S200L T1 Classic S200L mini T1 Line C200L (SN>68 381 & <43 000)	T1 Line C200L (SN<302 000 & >302 000) T1 Line C200L mini T2 Line A200 (SN<302 000 & >302 000)	T2 S-Line AS200L T3 S-LINE ES200 SIROPure P200SL SIROPure P200IL T3 LINE E200	<b>Llave Ref.: HE-821</b>
<b>Ref.: BVT-410</b> (Ref. Sirona®: 6049337)			<b>24<sup>80</sup>€</b>	
	T1 Classic S40L T1 Classic S6L T1 Classic S1,6L T1 Classic S40L (SN>202 000) T1 Classic S6L (SN>202 000) T1 Classic S1,6L (SN>202 000) T1 Classic C40L (SN>65 000) T1 Classic C6L (SN>65 000) T1 Classic C1,6L (SN>65 000) T1 Classic C40L (SN>202 000) T1 Classic C6L (SN>202 000) T1 Line C40 T1 Line C40 mini	T1 Line C40L T1 Line C40L mini T1 Line C6 T1 Line C6L mini T1 Line C1.6 T1 Line C1.6L T2 S-Line AS40L T2 S-Line AS6L T3 S-Line ES40 T3 S-Line ES6 SIROPure P40SL SIROPure P40IL SIROPure P6SL	SIROPure P6IL T2 Line A6L (SN>202 000) T2 Line A40L (SN>202 000) T3 Line E40 (SN>202 000) T3 Line E6 (SN>202 000) T1 Line C1,6L (SN >202 000)	<b>Llave Ref.: HE-821</b>
<b>Ref.: BVT-411</b> (Ref. Sirona®: 6049329)			<b>24<sup>80</sup>€</b>	
	Dentsply X-Smart Plus 6:1  <b>Ref.: BVT-433</b>			<b>Llave Ref.: HE-610</b>
			<b>29<sup>80</sup>€</b>	

## Modelos para Sirona®

## Relacionados

	<p>Dentsply X-Smart 16:1</p> <p>Ref.: <b>BVT-436</b></p> <p><b>24<sup>80</sup>€</b></p>	<p>Llave Ref.: HE-845</p>
	<p>TI Line ENDO 6L</p> <p>Ref.: <b>BVT-471</b> (Ref. Sirona®: 65444444)</p> <p><b>19<sup>80</sup>€</b></p>	<p>Llave Ref.: HE-821</p>

## Resto repuestos contra ángulos Sirona®

RUMAR

## Descripción

## Observaciones

	<p>Tubo irrigación azul contra ángulos y piezas de mano Sirona®  <b>***Original Sirona***</b></p> <p>Ref.: <b>BVX-8236</b> (Ref. 6328236 / 25)</p> <p><b>5<sup>30</sup>€</b></p>	<p>Pack: 2 Uds.</p>
---	--	---------------------

## REPUESTOS PARA CONTRA ÁNGULOS Y PIEZAS DE MANO MK-DENT®

## Rotores contra ángulos MK-dent®



## Modelos para MK-dent®

## Relacionados



	<p>LCH11 LPH11 LS9011</p> <p>Ref.: <b>BVR-SP2005</b></p> <p><b>121<sup>80</sup>€</b></p>	
---	--	--

## Ejes contra ángulos MK-dent®

RUMAR

## Modelos para MK-dent®

## Relacionados

	<p>LCH11                      LS9011 LPH11                      LS9016</p> <p>Ref.: <b>BVE-724</b> (Ref. MK-dent®: SP2024)</p> <p><b>48<sup>00</sup>€</b></p>	
	<p>LE11                              LS2011 LE11L                          LS2011L</p> <p>Ref.: <b>BVE-1010</b></p> <p><b>38<sup>00</sup>€</b></p>	

## Modelos para MK-dent®

## Relacionados

	LE15 LE15L		
	<b>Ref.: BVE-SP2246M1</b>	<b>148<sup>00</sup>€</b>	<b>HASTA AGOTAR</b>

## Tapas contra ángulos MK-dent®

RUMAR

## Modelos para MK-dent®



## Relacionados

	3 muescas LCH11 LCH21 LS9011	LS9021	
	<b>Ref.: BVT-704</b> (Ref. MK-dent®: 0.540.3741)	<b>25<sup>80</sup>€</b>	<b>Llave doble Ref.: HE-751</b>  <b>*Tapa original (4 lados)</b> <b>Llave Ref.: HE-2011T</b>

## Anillos Tóricos Contra Ángulos y Piezas de Mano MK-dent®

RUMAR

## Modelos para MK-dent®



	LC01 LC01L LC11 LC11L	LE11 (N/S: LN...)* LE11L (N/S: LN...)* LP01L LP11L	LS2011 LS2011L LS1011	<b>*Modelo actual</b> Para N/S: L... Ver OR-1514
	<b>Ref.: OR-1020</b> (Ref. MK-dent® SP1020)		<b>1<sup>80</sup>€</b>	
	LE11 (N/S: L...)* LE11L (N/S: L...)*			<b>*Modelo antiguo</b> Para N/S: LN... Ver OR-1020
	<b>Ref.: OR-1514</b> (Ref. MK-dent® SP1514)		<b>1<sup>80</sup>€</b>	















## Resto repuestos contra ángulos MK-dent®

RUMAR

## Descripción













## Observaciones

	Carcasa LCH11 y LS9011		
	<b>Ref.: BVX-706</b> (Ref. MK-dent®: SP2001)	<b>54<sup>80</sup>€</b>	
	Carcasa LCH21 y LS9021		
	<b>Ref.: BVX-2101</b>	<b>63<sup>80</sup>€</b>	
	Carcasa LS9016		
	<b>Ref.: BVX-2221</b> (Ref. MK-dent®: SP2221)	<b>58<sup>00</sup>€</b>	<b>HASTA AGOTAR</b>
	Segmento LCH11, LCH21, LPH11, LPH21, LS9011 y LS9021		
	<b>Ref.: BVX-702</b> (Ref. MK-dent®: SP2004)	<b>7<sup>80</sup>€</b>	
	Chaveta LCH11, LCH21, LPH11, LPH21, LS9011 y LS9021		
	<b>Ref.: BVX-703</b> (Ref. MK-dent®: SP2006)	<b>12<sup>80</sup>€</b>	

	Descripción	Observaciones
	Anillo de conducción LCH11, LCH21, LPH11, LPH21, LS9011 y LS9021  <b>Ref.: BVX-707</b> (Ref. MK-dent®: SP2007) <b>1'80.€</b>	Útil Ref.: HE-752
	Muelle LCH11, LCH21, LPH11, LPH21, LS9011 y LS9021  <b>Ref.: BVX-709</b> (Ref. MK-dent®: SP2023) <b>2'70.€</b>	
	Muelle de presión para LS2011 y LS2011L  <b>Ref.: BVX-1014</b> (Ref. MK-dent®: SP1014) <b>0'90.€</b>	
	Tornillo LCH11, LCH21, LPH11, LPH21, LS9011 y LS9021  <b>Ref.: BVX-708</b> (Ref. MK-dent®: SP2021) <b>1'90.€</b>	Destornillador: HE-2016, HE-753TOR.
	Anillo azul para: LE11, LE11L, LC11, LC11L y LP11L  <b>Ref.: BVX-0031</b> (Ref. MK-dent®: SP0031) <b>3'40.€</b>	
	Anillo de cierre para LS2011 y LS2011L (NO válido para líneas LE, LC o LP)  <b>Ref.: BVX-1003</b> (Ref. MK-dent®: SP1003) <b>26'40.€</b>	HASTA AGOTAR
	Anillo de alambre para LE11, LE11L, LC11, LC11L, LP11L, LS2011 y LS2011L  <b>Ref.: BVX-1005</b> (Ref. MK-dent®: SP1005) <b>1'00.€</b>	
	Bola para LE11, LE11L, LC11, LC11L, LP11L, LS2011 y LS2011L  <b>Ref.: BVX-1006</b> (Ref. MK-dent®: SP1006) <b>0'80.€</b>	3,0 mm
	Bola para LE11, LE11L, LC11, LC11L, LP11L, LS2011 y LS2011L  <b>Ref.: BVX-1007</b> (Ref. MK-dent®: SP1007) <b>0'80.€</b>	1,5 mm HASTA AGOTAR
	Distanciador para LE11, LE11L, LC11, LC11L, LP11L, LS2011 y LS2011L  <b>Ref.: BVX-1012</b> (Ref. MK-dent®: SP1012) <b>4'70.€</b>	HASTA AGOTAR
	Tope arrastre trasero para LE11, LE11L, LC11, LC11L, LP11L, LS2011 y LS2011L  <b>Ref.: BVX-1016</b> (Ref. MK-dent®: SP1016) <b>30'80.€</b>	
	Pasador para tope de arrastre para LE11, LE11L, LC11, LC11L, LP11L, LS2011 y LS2011L  <b>Ref.: BVX-1017</b> (Ref. MK-dent®: SP1017) <b>1'10.€</b>	
	Inserto LS2011 (NO válido para líneas LE, LC o LP)  <b>Ref.: BVX-1019</b> (Ref. MK-dent®: SP1019) <b>65'90.€</b>	HASTA AGOTAR
	Guía posicionamiento LS2011L. (NO válido para líneas LE, LC o LP)  <b>Ref.: BVX-1023</b> (Ref. MK-dent®: SP1023) <b>19'60.€</b>	HASTA AGOTAR
	Barra transmisión luz LE11L, LC11L y LP11L  <b>Ref.: BVX-9002</b> (Ref. MK-dent®: SP9002) <b>108'00.€</b>	

## Repuestos piezas de mano MK-dent®

RUMAR

	Descripción	Observaciones
	Anillo azul para LE01, LE01L, LC01, LC01L y LP01L <b>Ref.: BVX-0031</b> (Ref. MK-dent®: SP0031)	3´40€
	Eje completo para LE01, LE01L, LC01, LC01L y LP01L <b>Ref.: BVX-1138</b> (Ref. MK-dent®: SP1138)	224´80€
	Anillo cierre para LS1011 <b>Ref.: BVX-1039</b> (Ref. MK-dent®: SP1039)	55´80€
	Cartucho para rodamiento para LS1011 <b>Ref.: BVX-1040</b> (Ref. MK-dent®: SP1040)	48´20€ <b>HASTA AGOTAR</b>
	Anillo para LS1011 <b>Ref.: BVX-1041</b> (Ref. MK-dent®: SP1041)	8´00€ <b>HASTA AGOTAR</b>
	Perno para LS1011 <b>Ref.: BVX-1042</b> (Ref. MK-dent®: SP1042)	5´50€ <b>HASTA AGOTAR</b>
	Anillo roscado para LS1011 <b>Ref.: BVX-1043</b> (Ref. MK-dent®: SP1043)	6´90€ <b>HASTA AGOTAR</b>
	Arandela para LS1011 <b>Ref.: BVX-1044</b> (Ref. MK-dent®: SP1044)	4´40€ <b>HASTA AGOTAR</b>
	Tornillo para LS1011 <b>Ref.: BVX-1045</b> (Ref. MK-dent®: SP1045)	1´40€ <b>HASTA AGOTAR</b>
	Inserto para LS1011 <b>Ref.: BVX-1046</b> (Ref. MK-dent®: SP1046)	64´20€ <b>HASTA AGOTAR</b>
	Clip para LS1011 <b>Ref.: BVX-1047</b> (Ref. MK-dent®: SP1047)	1´90€ <b>HASTA AGOTAR</b>
	Tope arrastre trasero para LS1011 <b>Ref.: BVX-1016</b> (Ref. MK-dent®: SP1016)	30´80€
	Pasador para tope arrastre para LS1011 <b>Ref.: BVX-1017</b> (Ref. MK-dent®: SP1017)	1´50€

# REPUESTOS PARA CONTRA ÁNGULOS Y PIEZAS DE MANO CASTELLINI®

## Rotores compatibles contra ángulos Castellini®

RUMAR

Modelos para Castellini®		Relacionados
	<p>Goldspeed EVO S1</p> <p>Ref.: <b>BVR-483</b></p> <p><b>178<sup>80</sup>€</b></p>	<p>Tapa Ref.: BVT-484</p> <p><b>BAJO PEDIDO</b></p>
	<p>Goldspeed S1 Goldspeed SIL</p> <p>Ref.: <b>BVR-380</b></p> <p><b>68<sup>80</sup>€</b></p>	<p>Eje Ref.: BVE-396 Tapa Ref.: BVT-485</p>



## Ejes compatibles contra ángulos Castellini®

RUMAR

Modelos para Castellini®		Relacionados
	<p>Goldspeed S1 Goldspeed SIL</p> <p>Ref.: <b>BVE-396</b></p> <p><b>48<sup>00</sup>€</b></p>	

## Tapas compatibles contra ángulos Castellini®

RUMAR

Modelos para Castellini®		Relacionados
	<p>Goldspeed S1 Goldspeed SIL (Excepto Goldspeed <b>EVO</b> S1 y Goldspeed <b>EVO</b> S1-L)</p> <p>Ref.: <b>BVT-485</b></p> <p><b>42<sup>80</sup>€</b></p>	<p>Llave Ref.: HE-833</p>
	<p>Goldspeed <b>EVO</b> S1</p> <p>Ref.: <b>BVT-484</b></p> <p><b>68<sup>00</sup>€</b></p>	<p>Llave Ref.: HE-834</p>

## REPUESTOS PARA CONTRA ÁNGULOS Y PIEZAS DE MANO BA INTERNACIONAL®

### Rotores compatibles contra ángulos BA International®

RUMAR

	Modelos para BA International®	Relacionados
	B.A40LSS B.A40SS B.A45LS  <b>Ref.: BVR-417</b>	<b>Eje Ref.: BVE-421</b>  <b>98'00€</b>

### Ejes compatibles contra ángulos BA International®



RUMAR

	Modelos para BA International®	Relacionados
	BA45S BA40LSS BA40SS  <b>Ref.: BVE-421</b>	  <b>68'00€</b>

## REPUESTOS PARA CONTRA ÁNGULOS Y PIEZAS DE MANO WOODPECKER® / DTE®

### Rotores contra ángulos WOODPECKER® / DTE®



	Modelos para WOODPECKER® / DTE®	Relacionados
	Kit rotor + tapa + arandela WP-1 WP-1L* (IMPLANTER LED / DTE IMPLANT X LED) <b>*Contra ángulos con uno y dos tornillos</b>  <b>Ref.: 28-CA001</b>	<b>Eje Ref. WP-1L: 28-CA002</b> <b>Tapa Ref.: 28-CA003</b>  <b>Eje Ref. WP-1: 28-CA008</b> Suministro incluye: Tapa, rotor y arandela.  <b>168'00€</b>
	Rotor WJ-45TL  <b>Ref.: 28-CA010</b>	<b>Eje Ref.: 28-CA011</b> <b>Tapa Ref.: 28-CA015</b>  <b>168'00€</b>
 <small>Imagen no disponible</small>	Rotor WJ-11L  <b>Ref.: 28-CA016</b>	<b>Eje Ref.: 28-CA017</b> <b>Tapa Ref.: 28-CA018</b>  <b>98'00€</b>

NUEVO

Ejes contra ángulos **WOODPECKER® / DTE®**Modelos para **WOODPECKER® / DTE®**

## Relacionados

	<p>WP-1L (IMPLANTER LED / DTE IMPLANT X LED) *Contra ángulos con uno y dos tornillos*</p> <p>Ref.: <b>28-CA002</b></p> <p><b>102´80€</b></p>		
	<p>WP-1</p> <p>Ref.: <b>28-CA008</b></p> <p><b>102´80€</b></p>	<p>Llave Ref.: 28-CA006</p>	
	<p>WJ-45TL</p> <p>Ref.: <b>28-CA011</b></p> <p><b>102´80€</b></p>		
<b>NUEVO</b>	 <small>Imagen no disponible</small>	<p>WJ-11L</p> <p>Ref.: <b>28-CA017</b></p> <p><b>98´00€</b></p>	

Tapas contra ángulos **Woodpecker® / DTE®**Modelos para **WOODPECKER® / DTE®**

## Relacionados

	<p>WP-1 WP-1L* (IMPLANTER LED / DTE® IMPLANT X LED) *Contra angulos con uno y dos tornillos</p> <p>Ref.: <b>28-CA003</b></p> <p><b>29´80€</b></p>	<p>Rotor Ref.: 28-CA001 Llave Ref.: 28-CA005</p>	
	<p>WJ-45TL</p> <p>Ref.: <b>28-CA013</b></p> <p><b>24´80€</b></p>	<p>Rotor Ref.: 28-CA010 Llave Ref.: 28-CA015</p>	
<b>NUEVO</b>	 <small>Imagen no disponible</small>	<p>WJ-11L</p> <p>Ref.: <b>28-CA018</b></p> <p><b>18´00€</b></p>	<p>Rotor Ref.: 28-CA016</p>

Resto repuestos contra ángulos **Woodpecker® / DTE®**

	Descripción	Observaciones
 <p data-bbox="124 302 220 313">Imagen no disponible</p>	<p data-bbox="336 212 1177 324">Carcasa cabeza WP-1L contra ángulos con dos tornillos</p> <p data-bbox="336 331 1177 369"><b>Ref.: 28-CA007</b></p> <p data-bbox="1061 331 1177 369"><b>50<sup>80</sup>€</b></p>	
	<p data-bbox="336 403 1177 515">Carcasa cabeza WP-1</p> <p data-bbox="336 521 1177 560"><b>Ref.: 28-CA009</b></p> <p data-bbox="1069 521 1177 560"><b>16<sup>10</sup>€</b></p>	
	<p data-bbox="336 593 1177 705">Carcasa cabeza WJ-45TL</p> <p data-bbox="336 712 1177 750"><b>Ref.: 28-CA012</b></p> <p data-bbox="1061 712 1177 750"><b>42<sup>80</sup>€</b></p>	

Otros repuestos contra ángulos **Woodpecker® / DTE®**

	Modelos para WOODPECKER® / DTE®	Relacionados
	<p data-bbox="336 969 1189 1081">Tornillo WJ-45TL</p> <p data-bbox="336 1088 1189 1126"><b>Ref.: 28-CA014</b></p> <p data-bbox="1093 1088 1189 1126"><b>1<sup>80</sup>€</b></p>	









Todos los rodamientos que ofrecemos están fabricados por los principales fabricantes de rodamientos a nivel mundial: **myonic, HQW-Barden, GRW, NMB, EZO o ESC**. Todos fabricados de acuerdo a las normas de precisión ISO\* (normas para rodamientos de dimensiones métricas) y ABEC\*\* (rodamientos generalmente en dimensiones de pulgadas).











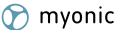

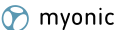

## RODAMIENTOS PARA CONTRA ÁNGULOS Y PIEZAS DE MANO KAVO®

### Rodamientos contra ángulos KaVo®

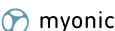

RUMAR

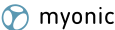



Modelos para KaVo®			Descripción
 <p>myonic</p>	Delantero cabeza 67LH Delantero cabeza 68LH Delantero cabeza 2068CHC	Delantero cabeza 2068LHC Delantero cabeza L68 Delantero cabeza L67	Delantero cabeza C3  <b>Medidas:</b> 3x7x2,5/3,35mm <b>Especial</b> Exterior: Liso Bola: Acero Retenedor: Torlon Abierto-Cerrado
 <p>myonic</p>	Trasero cabeza 67LH Trasero cabeza 68 LH Trasero cabeza 2068CHC	Trasero cabeza 2068LHC Trasero cabeza L68 Trasero cabeza L67	<b>Medidas:</b> 4x7x2mm Exterior: Liso Bola: Acero Retenedor: Acero Cerrado-Cerrado
 <p>myonic</p>	Delantero cabeza 67LDN Delantero cabeza 68LDN Delantero cabeza 67RIC		<b>Medidas:</b> 3x7x3mm Exterior: Liso Bola: Acero Retenedor: Acero Cerrado-Cerrado
 <p>myonic</p>	Trasero cabeza 67LDN Trasero cabeza 68LDN		<b>Medidas:</b> 4x7x2mm Exterior: Liso Bola: Acero Retenedor: Acero Abierto-Abierto
 <p>HQW BARDEN</p>	Trasero cabeza 67RIC Trasero cabeza C3		<b>Medidas:</b> 5x8x2mm Exterior: Liso Bola: Acero Retenedor: Acero Cerrado-Cerrado
	Cabeza 31LR Cabeza 52LDN Cabeza 67IC	Cabeza 68G	<b>Medidas:</b> 3x6x2mm Exterior: Liso Bola: Acero Retenedor: Acero Cerrado-Cerrado
 <p>myonic</p>	20CN 20LN 20CH	20LH 2068CHC 2068LHC	2068C E20 E20L
 <p>myonic</p>	Cabeza 24LN		<b>Medidas:</b> 4x7x2mm Exterior: Liso Bola: Cerámica Retenedor: Torlon Abierto-Cerrado

Modelos para KaVo®			Observaciones
	25CH 25CHC 25CN 25LH	25LHS 25LN 25LS 25LHC	25LHD Trasero 25LP
	<b>Ref.: ROD-325</b> (Ref. KaVo®: 1.001.2836 / 0.220.1307)		<b>33<sup>80</sup>€</b> <b>Medidas:</b> 4x7x2mm <b>Especial</b> Exterior: Liso Bola: Cerámica Retenedor: Torlon Abierto-Cerrado
	Delantero cabeza 25LP Delantero cabeza 25LPA		
	<b>Ref.: ROD-317</b> (Ref. KaVo®: 1.001.3167)		<b>30<sup>80</sup>€</b> <b>Medidas:</b> 3,175x6,35x2,778mm <b>Especial</b> Exterior: Liso Bola: Cerámica Retenedor: Torlon Abierto-Abierto
	Delantero cabeza E25L Delantero cabeza E25C		
	<b>Ref.: ROD-320</b> (Ref. KaVo®: 1.008.4038)		<b>30<sup>80</sup>€</b> <b>Medidas:</b> 3,175x6,35x1,905/2,778mm <b>Especial</b> Exterior: Liso Bola: Cerámica Retenedor: Torlon Abierto-Abierto
	Trasero cabeza E25L Trasero cabeza E25C		
	<b>Ref.: ROD-321</b> (Ref. KaVo®: 1.008.4039)		<b>30<sup>80</sup>€</b> <b>Medidas:</b> 4x7x2mm <b>Especial</b> Exterior: Liso Bola: Cerámica Retenedor: Torlon Abierto-Cerrado
	Eje 25LP Eje 25LPA Acoplador 25LP	Acoplador 25LPA Trasero eje E25L Trasero eje E25C	
	<b>Ref.: ROD-322</b> (Ref. KaVo®: 1.001.2834)		<b>19<sup>80</sup>€</b> <b>Medidas:</b> 2x5x1,5mm Exterior: Liso Bola: Acero Retenedor: Torlon Abierto-Abierto
	Acoplador E25L Acoplador E25C Acoplador 25LH Acoplador 25CH	Acoplador 25CHC Acoplador 25CN Acoplador 25LHS Acoplador 25LN	Acoplador 25LS Acoplador 25LHC Acoplador 25LHD
	<b>Ref.: ROD-323</b> (Ref. KaVo®: 0.220.0171)		<b>16<sup>80</sup>€</b> <b>Medidas:</b> 4X9X2,5mm <b>Especial</b> Exterior: Liso Bola: Acero Retenedor: Acero Abierto-Abierto
	Eje 25LH Eje 25CH Eje 25CHC Eje 25CN Eje 25LH Eje 25LHS Eje 25LN Eje 25LS Eje 25LHC Eje 25LHD	Engranaje Intermedio 25LH Engranaje Intermedio 25CH Engranaje Intermedio 25CHC Engranaje Intermedio 25CN Engranaje Intermedio 25LH Engranaje Intermedio 25LHS Engranaje Intermedio 25LN Engranaje Intermedio 25LS Engranaje Intermedio 25LHC Engranaje Intermedio 25LHD	Delantero eje E25L Delantero eje E25C
	<b>Ref.: ROD-324</b> (Ref. KaVo®: 0.220.0730)		<b>24<sup>80</sup>€</b> <b>Medidas:</b> 2,35x5x1,5mm Exterior: Liso Bola: Acero Retenedor: Torlon Abierto-Abierto

## Rodamientos piezas de mano KaVo®

RUMAR

Modelos para KaVo®		Descripción
	Trasero 10A (NO 10C)	
	<b>Ref.: ROD-5014</b> (Ref. KaVo®: 0.220.0103)	<b>16<sup>60</sup>€</b> <b>Medidas:</b> 4x9x4mm Exterior: Liso Bola: Acero Retenedor: Acero Cerrado-Cerrado

Modelos para KaVo®		Observaciones
 myonic	Trasero 10C  <b>Ref.: ROD-200</b> (Ref. KaVo®: 0.220.0126)	<b>Medidas:</b> 5x11x5mm Exterior: Liso Bola: Acero Retenedor: Acero Cerrado-Cerrado  <b>12'80€</b>
 myonic	Delantero 10CH Delantero 10LC Delantero 10CHC  Delantero 10CN Delantero 10LN 10C (Confirmar alto previamente)	<b>Medidas:</b> 5x8x3mm Exterior: Liso Bola: Acero Retenedor: Acero Cerrado-Cerrado  <b>16'80€</b>
 myonic	Delantero 15CN Series  <b>Ref.: ROD-303</b> (Ref. KaVo®: 0.220.1306)	<b>Medidas:</b> 5x9,525x3,175mm <b>Especial</b> Exterior: Liso Bola: Acero Retenedor: Bronce Cerrado-Cerrado  <b>42'80€</b>
 myonic	Trasero 15CN Series Trasero 10CN Trasero 10LN  Trasero 10CH Trasero 10LC Trasero 10CHC	<b>Medidas:</b> 4x9x4mm <b>Especial</b> Exterior: Liso Bola: Acero Retenedor: Acero Cerrado-Cerrado  <b>31'80€</b>

## RODAMIENTOS PARA CONTRA ÁNGULOS Y PIEZAS DE MANO NSK®

### Rodamientos contra ángulos NSK®

RUMAR

Modelos para NSK®		Descripción
 myonic	Cabeza T125 Cabeza X95 Cabeza X95L  Cabeza X85 Cabeza X85L  <b>Ref.: ROD-326</b>	<b>Medidas:</b> 4x7x2mm <b>Especial</b> Exterior: Liso Bola: Cerámica Retenedor: Tórlon Abierto-Abierto  <b>29'80€</b>
 myonic	Delantero Ti-Max X-SG20L Delantero Ti-Max X-DSG20L Delantero S-Max SG20 Delantero S-Max SG20L  <b>Ref.: ROD-309</b>	<b>Medidas:</b> 4x7x2mm <b>Especial</b> Exterior: Liso Bola: Acero Sin retenedor Abierto-Cerrado  <b>32'80€</b>
 HAW BARDEN	Trasero Ti-Max X-SG20L Trasero Ti-Max X-DSG20L Trasero S-Max SG20 Trasero S-Max SG20L  <b>Ref.: ROD-318</b>	<b>Medidas:</b> 5x8x2mm Exterior: Liso Bola: Acero Retenedor: Acero Cerrado-Cerrado  <b>16'80€</b>
 HAW BARDEN	Eje SG20  <b>Ref.: ROD-306</b>	<b>Medidas:</b> 2,35x5,5x2mm Exterior: Liso Bola: Acero Retenedor: Acero Abierto-Abierto  <b>13'80€</b>

## Modelos para NSK®

## Observaciones



 myonic

Eje SG20

Ref.: **ROD-308****19<sup>80</sup>€**

**Medidas:** 2,35x5,5x2mm  
Exterior: Liso  
Bola: Acero  
Retenedor: Torlon  
Abierto-Abierto

## Rodamientos piezas de mano NSK®

RUMAR

## Modelos para NSK®

## Descripción





Trasero EX5  
Trasero EX6  
Trasero EX7  
Trasero EX8Trasero EX9  
Trasero EX12  
Trasero IS65Ref.: **ROD-313** (Ref. NSK®: B10321-1005)**9<sup>80</sup>€**

**Medidas:** 5x10x3mm  
Exterior: Liso  
Bola: Acero  
Retenedor: Acero  
Abierto-Abierto



Trasero X65  
Trasero X65LRef.: **ROD-328** (Ref. NSK®: B11223-1005)**10<sup>20</sup>€**

**Medidas:** 5x10x4mm  
Exterior: Liso  
Bola: Acero  
Retenedor: TN9 Sintético  
Cerrado-Cerrado





Delantero EX5  
Delantero EX6  
Delantero EX7  
Delantero EX8Delantero EX9  
Delantero EX12  
Delantero IS65Ref.: **ROD-314** (Ref. NSK®: B13213-0804)**10<sup>20</sup>€**

**Medidas:** 4x8x3mm  
Exterior: Liso  
Bola: Acero  
Retenedor: Acero  
Cerrado-Cerrado

## RODAMIENTOS PARA CONTRA ÁNGULOS Y PIEZAS DE MANO W&amp;H®

## Rodamientos contra ángulos W&amp;H®

RUMAR

## Modelos para W&amp;H®

## Descripción



Cabeza WA-56LT nuevo  
Cabeza WA-56A nuevoRef.: **ROD-300** (Ref. W&H®: 05039400)**26<sup>80</sup>€**









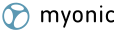

**Medidas:** 4x7x1,6mm  
Exterior: Liso  
Bola: Acero  
Retenedor: Acero  
Abierto-Abierto

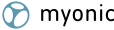

 myonic

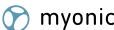

Cabeza WE99 LED-G  
Cabeza WE99A  
Cabeza WE99ERef.: **ROD-326** (Ref. W&H®: 02649400 / 04486000)**29<sup>80</sup>€**

**Medidas:** 4x7x2mm  
**Especial**  
Exterior: Liso  
Bola: Cerámica Retenedor: Torlon  
Abierto-Abierto

Modelos para KaVo®			Observaciones	
	Cabeza WA-56LT Cabeza WA-56A Cabeza WA-66LT Cabeza WA-66A Cabeza WA-86LT Cabeza WA-86A Cabeza A956E Cabeza A956A Cabeza A956LT Cabeza A956LX Cabeza 966E Cabeza 966A Cabeza 966LT	Cabeza 966LX Cabeza 975E Cabeza 975A Cabeza 975LT Cabeza 975LX Cabeza 985E Cabeza 985A Cabeza 985LT Cabeza 985LX Cabeza 986E Cabeza 986A Cabeza 986LT Cabeza 986LX	Cabeza 988E Cabeza 988E-KM Cabeza WE-56 LED G Cabeza WS-75E Cabeza WS-75KM Friatec 90 Friatec 5040 Delantero y medio acople WS-75E Delantero y medio acople WS-75KM	<b>Medidas:</b> 4x7x2mm Exterior: Liso Bola: Acero Retenedor: Acero Abierto-Abierto
	<b>Ref.: ROD-301</b> (Ref. W&H®: 01589600)		<b>14<sup>80</sup>€</b>	
	Cabeza WS-75E Cabeza WS-75KM Cabeza WI75			<b>Medidas:</b> 4x7x2mm <b>Especial</b> Exterior: Liso Bola: Acero Sin retenedor Abierto-Cerrado
	<b>Ref.: ROD-309</b> (Ref. W&H®: 04027300)		<b>32<sup>80</sup>€</b>	
	Pieza intermedia WA-56LT Pieza intermedia WA-56A Pieza intermedia WA56LT nuevos Pieza intermedia WA-62LT Pieza intermedia WA-62A	Pieza intermedia WA-66LT Pieza intermedia WA-66A Pieza intermedia WA-67LT Pieza intermedia WA-67A Pieza intermedia WA-86LT	Pieza intermedia WA-86A Pieza intermedia WS-75E Pieza intermedia WS-75KM	<b>Medidas:</b> 2,35x5,5x2mm Exterior: Liso Bola: Acero Retenedor: Acero Abierto-Abierto
	<b>Ref.: ROD-306</b> (Ref. W&H®: 01579300 / 04733900)		<b>13<sup>80</sup>€</b>	
	Delantero eje WA-56LT Delantero eje WA-56A Delantero eje WA-62LT Delantero eje WA-62A Delantero eje WA-66LT Delantero eje WA-66A Delantero eje WA-67LT Delantero eje WA-67A	Delantero eje WA-86LT Delantero eje WA-86A nuevos y antiguos Delantero eje WD-56 Delantero eje WD-57 Delantero eje WD-58 Delantero eje WD-64 Delantero eje WD-66	Delantero eje WD-71 Delantero eje WD-72 Delantero eje WD-73 Delantero eje WD-74 Delantero eje HD-43 Delantero eje HP-44 Delantero eje WS-75E	<b>Medidas:</b> 3x7x2mm Exterior: Liso Bola: Acero Retenedor: Acero Abierto-Abierto
	<b>Ref.: ROD-307</b> (Ref. W&H®: 01589400)		<b>12<sup>80</sup>€</b>	
	Trasero eje WA-56LT Trasero eje WA-56A Trasero eje WA-62LT Trasero eje WA-62A Trasero eje WA-66LT Trasero eje WA-66A Trasero eje WA-67LT Trasero eje WA-67A	Trasero eje WA-86LT Trasero eje WA-86A nuevos y antiguos Trasero eje WD-56 Trasero eje WD-57 Trasero eje WD-58 Trasero eje WD-64 Trasero eje WD-66	Trasero eje WD-71 Trasero eje WD-72 Trasero eje WD-73 Trasero eje WD-74 Trasero eje HD-43 Trasero eje HP-44 Trasero eje WS-75E Trasero eje WS-75KM	<b>Medidas:</b> 3x10x4mm Exterior: Liso Bola: Acero Retenedor: Acero Abierto-Abierto
	<b>Ref.: ROD-302</b> (Ref. W&H®: 01577000)		<b>12<sup>20</sup>€</b>	
	Pieza intermedia WA-99 Pieza intermedia WA-969 Pieza intermedia WA-999			<b>Medidas:</b> 2,35x5,5x2mm Exterior: Liso Bola: Acero Retenedor: Torlon Abierto-Abierto
	<b>Ref.: ROD-308</b> (Ref. W&H®: 01579600)		<b>19<sup>80</sup>€</b>	

## Rodamientos piezas de mano W&amp;H®

RUMAR

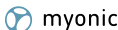
Modelos para W&H®		Descripción
 	Trasero S11 Trasero Synea® HA43A  <b>Ref.: ROD-302</b>	<b>Medidas:</b> 3x10x4mm Exterior: Liso Bola: Acero Retenedor: Acero Abierto-Abierto
 	Delantero WH S11 Delantero Synea® HA43A  <b>Ref.: ROD-7185</b>	<b>Medidas:</b> 5x8x3mm Exterior: Liso Bola: Acero Retenedor: Acero Cerrado-Cerrado

## RODAMIENTOS PARA CONTRA ÁNGULOS Y PIEZAS DE MANO BIEN AIR®

## Rodamientos contra ángulos Bien Air®

RUMAR

Modelos para Bien Air®		Descripción
 	Cabeza 1132 Trasero cabeza Serie Microseries  <b>Ref.: ROD-301</b> (Ref. Bien Air®: 701.01.81)	<b>Medidas:</b> 4x7x2mm Exterior: Liso Bola: Acero Retenedor: Acero Abierto-Abierto
 	Delantero cabeza Serie Microseries  <b>Ref.: ROD-318</b>	<b>Medidas:</b> 5x8x2mm Exterior: Liso Bola: Acero Retenedor: Acero Cerrado-Cerrado
 	Eje intermedio 1:1 Eje intermedio 1:4 Eje intermedio 1:5  <b>Ref.: ROD-315</b> (Ref. Bien Air®: 701.01.75)	<b>Medidas:</b> 2,35x4,763x2,35mm Exterior: Liso Bola: Acero Retenedor: Acero Cerrado-Cerrado

## Rodamientos piezas de mano Bien Air®





RUMAR

Modelos para Bien Air®		Descripción
 	Trasero 1:1 (Ref.: 160.03.83)      Trasero 1:2 (Ref.: 160.02.95)  <b>Ref.: ROD-302</b> (Ref. Bien Air®: 701.01.65 / 1301333)	<b>Medidas:</b> 3x10x4mm Exterior: Liso Bola: Acero Retenedor: Acero Abierto-Abierto
 	Delantero 1:1 (Ref.: 160.03.83)      Delantero 1:2 (Ref.: 160.02.95)  <b>Ref.: ROD-7185</b> (Ref. Bien Air®: 701.01.53 / 1301332)	<b>Medidas:</b> 5x8x3mm Exterior: Liso Bola: Acero Retenedor: Acero Cerrado-Cerrado

# RODAMIENTOS PARA CONTRA ÁNGULOS Y PIEZAS DE MANO SIRONA®

## Rodamientos contra ángulos Sirona®



RUMAR



Modelos para Sirona®		Descripción
	Delantero cabeza T1 Line C40 Delantero cabeza T1 Line C40L  <b>Ref.: ROD-307</b>	<b>Medidas:</b> 3x7x2mm Exterior: Liso Bola: Acero Retenedor: Acero Abierto-Abierto  <b>12´80€</b>
 myonic	Trasero cabeza T1 Line C40 Trasero cabeza T1 Line C40L  <b>Ref.: ROD-309</b>	<b>Medidas:</b> 4x7x2mm <b>Especial</b> Exterior: Liso Bola: Acero Sin retenedor Abierto-Cerrado  <b>32´80€</b>
 ISC	Delantero T2 REVO  <b>Ref.: ROD-305</b>	<b>Medidas:</b> 3x6x2mm Exterior: Liso Bola: Acero Retenedor: Acero Cerrado-Cerrado  <b>13´30€</b>
 HAW BARDEN	Trasero T2 REVO  <b>Ref.: ROD-300</b>	<b>Medidas:</b> 4x7x1,6mm Exterior: Liso Bola: Acero Retenedor: Acero Abierto-Abierto  <b>26´30€</b>
 myonic	T1 Line C200 mini T1 Classic S200 mini  <b>Ref.: ROD-353</b>	<b>Medidas:</b> 3,175x6x2mm Exterior: Liso Bola: Acero Retenedor: Acero Abierto-Abierto  <b>28´80€</b>

# RODAMIENTOS PARA CONTRA ÁNGULOS Y PIEZAS DE MANO MK-DENT®

## Rodamientos contra ángulos MK-dent®





RUMAR

Modelos para MK-dent®		Descripción
 myonic	Delantero cabeza LS9011 Delantero cabeza LS9021 Delantero cabeza LCH11 Delantero cabeza LCH21 Delantero cabeza LPH11 Delantero cabeza LPH21  <b>Ref.: ROD-5011</b>	<b>Medidas:</b> 3x7x2,5/3,35mm <b>Especial</b> Exterior: Liso Bola: Acero Retenedor: Tornón Abierto-Cerrado  <b>18´90€</b>
 myonic	Trasero cabeza LS9011 Trasero cabeza LS9021 Trasero cabeza LCH11 Trasero cabeza LCH21 Trasero cabeza LPH11 Trasero cabeza LPH21  <b>Ref.: ROD-5012</b>	<b>Medidas:</b> 4x7x2mm Exterior: Liso Bola: Acero Retenedor: Acero Cerrado-Cerrado  <b>16´10€</b>

Modelos para MK-dent®			Descripción
 	LC11 LC11L LE11	LE11L LP11L LS2011	LS2011L LS3011 LS3011L
	<b>Ref.: ROD-0218</b>		<b>11'80€</b> <b>Medidas:</b> 3x8x3mm Exterior: Liso Bola: Acero Retenedor: Acero Cerrado-Cerrado

### Rodamientos piezas de mano MK-dent®





RUMAR

Modelos para MK-dent®			Descripción
 	Trasero LC01 Trasero LC01L	Trasero LE01 Trasero LE01L	Trasero LP01L Trasero LS1011
	<b>Ref.: ROD-5014</b>		<b>16'60€</b> <b>Medidas:</b> 4x9x4mm Exterior: Liso Bola: Acero Retenedor: Acero Cerrado-Cerrado
 	Delantero LC01 Delantero LC01L	Delantero LE01 Delantero LE01L	Delantero LP01L Delantero LS1011
	<b>Ref.: ROD-7185</b>		<b>16'80€</b> <b>Medidas:</b> 5x8x3mm Exterior: Liso Bola: Acero Retenedor: Acero Cerrado-Cerrado

## RODAMIENTOS PARA CONTRA ÁNGULOS Y PIEZAS DE MANO RUMAR®

### Rodamientos piezas de mano RUMAR®

RUMAR

Modelos para RUMAR®			Descripción
 	Trasero ECO P1		<b>9'80€</b> <b>Medidas:</b> 5x10x3mm Exterior: Liso Bola: Acero Retenedor: Acero Abierto-Abierto
	<b>Ref.: ROD-313</b>		
 	Delantero ECO P1		<b>10'20€</b> <b>Medidas:</b> 4x8x3mm Exterior: Liso Bola: Acero Retenedor: Acero Cerrado-Cerrado
	<b>Ref.: ROD-314</b>		

# REPUESTOS PARA MICROMOTORES KAVO®



## Rotores compatibles Micromotores KaVo®

RUMAR

	Descripción	Observaciones
	K190 K196 <b>Ref.: BVR-101</b> (Ref. KaVo®: 0.676.0871)	316 <sup>80</sup> €
	K192 <b>Ref.: BVR-102</b> (Ref. KaVo®: 0.676.0971)	316 <sup>80</sup> €
	K200 <b>Ref.: BVR-103</b> (Ref. KaVo®: 1.000.6859)	328 <sup>00</sup> €
	K201 <b>Ref.: BVR-104</b> (Ref. KaVo®: 1.001.8992)	318 <sup>00</sup> €
	K9 EWL 950 K9 EWL 955 <b>Ref.: BVR-110</b> (Ref. KaVo®: 0.674.1261 / 1.000.2200)	308 <sup>00</sup> €
	K10 <b>Ref.: BVR-111</b> (Ref. KaVo®: 0.674.3321)	374 <sup>80</sup> €

## Escobillas compatibles Micromotores KaVo®



RUMAR

	Descripción	Observaciones
	Motores INTRA: K191 K196 K200 K190 K192 K197 K201 <b>Ref.: BVE-260/2</b> (Ref. KaVo®: 0.676.0881)	Pack 2 uds. 22 <sup>80</sup> €
	K9 <b>Ref.: BVE-250/2</b> (Ref. KaVo®: 0.676.0241)	Pack 2 uds. 22 <sup>80</sup> €
	K10 <b>Ref.: BVE-251/2</b> (Ref. KaVo®: 0.674.2481)	Pack 2 uds. 25 <sup>80</sup> €

## Pinzas compatibles Micromotores KaVo®



		Descripción	Observaciones
	2,35 mm	K11 K9 EWL 950 (antiguo) <b>Ref.: BVP-401</b> (Ref. KaVo®: 0.674.7752)	K9 EWL 955 (antiguo) K10 4950 <b>48'50€</b>
	2,35 mm	K10 (excepto 4950) K12 K4 <b>Ref.: BVP-402</b> (Ref. KaVo®: 0.674.4871)	K5 K9 EWL 4930 nuevo (azul) K9 EWL 4932 nuevo (azul) K9 EWL 4933 nuevo (azul) Power Grip todos los modelos <b>52'60€</b>
	2,35 mm	SF EWL 4004 SF EWL 4005 <b>Ref.: BVP-444</b> (Ref. KaVo®: 0.671.1562)	<b>42'80€</b>

## Anillos tóricos compatibles micromotores KaVo®

		Descripción	Observaciones
		Anillo tórico sistema INTRA todos los modelos / <b>TODAS LAS PRIMERAS MARCAS</b> <b>Ref.: OR-148</b> (Ref. KaVo®: 0.200.6120)	<b>1'10€</b>
		Anillo tórico K9, K10 <b>Ref.: OR-2408</b> (Ref. KaVo®: 0.224.2408)	<b>0'90€</b>
		Anillo tórico K4, K5, K9 <b>Ref.: OR-445</b> (Ref. KaVo®: 0.200.6199)	<b>1'00€</b> <b>HASTA AGOTAR</b>

## Otros repuestos compatibles micromotores KaVo®



		Descripción	Observaciones
		Pasador tope arrastre todos los modelos <b>***Original KaVo®***</b> <b>Ref.: BVX-432</b> (Ref. KaVo®: 0.202.0018)	Medidas: 1x4,5mm <b>2'60€</b>
		Tapa K9, K10 (Gris) <b>Ref.: BVX-439</b> (Ref. KaVo®: 0.674.2861)	<b>31'90€</b>
		Varilla sujeción SF EWL 4004 Varilla sujeción SF EWL 4005 <b>Ref.: BVX-441</b> (Ref. KaVo®: 0.674.3052)	<b>39'80€</b> <b>HASTA AGOTAR</b>
		Tope de arrastre varilla K9, K10, K11 <b>Ref.: BVX-430</b> (Ref. KaVo®: 0.674.4192)	<b>25'80€</b>
		Pasador tope arrastre todos los modelos <b>***Original KaVo®***</b> <b>Ref.: BVX-432</b> (Ref. KaVo®: 0.202.0018)	Medidas: 1x4,5mm <b>2'60€</b>
		Lámina SF EWL 4004 Lámina SF EWL 4005 <b>Ref.: BVX-442</b> (Ref. KaVo®: 0.674.3062)	<b>33'80€</b> <b>HASTA AGOTAR</b>

	Descripción	Observaciones
	Cojinete guía alta frecuencia SF EWL 4004 Cojinete guía alta frecuencia SF EWL 4005  <b>Ref.: BVX-443</b> (Ref. KaVo®: 0.674.0532)	48´80€ <span style="float: right; background-color: yellow;">HASTA AGOTAR</span>
	Ventilador SF EWL 4004 Ventilador SF EWL 4005  <b>Ref.: BVX-451</b> (Ref. KaVo®: 0.674.2911)	16´80€ <span style="float: right; background-color: yellow;">HASTA AGOTAR</span>
	Tuerca roscada: K9 EWL 4930 nuevo (azul) K9 EWL 4932 nuevo (azul)  <b>Ref.: BVX-255</b> (Ref. 1.000.1260)	9´80€ <span style="float: right; background-color: yellow;">HASTA AGOTAR</span>

## REPUESTOS PARA MICROMOTORES NSK®



### Escobillas Micromotores NSK®

RUMAR

	Descripción	Observaciones
	Volvere y M40 <b>***Original NSK®***</b>  <b>Ref.: BVE-275/2</b> (Original Ref. NSK®: E023011S)	Pack 2 uds.
	MX90 459TM 459L  <b>Ref.: BVE-270/2</b>	Pack 2 uds.

### Pinzas compatibles Micromotores NSK®

RUMAR

	Descripción	Observaciones
	2.35 mm Ultimate XL 500 450 Volvere Vmax  <b>Ref.: BVP-405</b>	48´00€
	Presto Aqua Lux Presto II Aqua II  <b>Ref.: BVP-407</b> (Ref.NSK® T815019)	42´80€

### Anillos tóricos compatibles micromotores NSK®

RUMAR

	Descripción	Observaciones
	Anillo tórico sistema INTRA todos los modelos / <b>TODAS LAS PRIMERAS MARCAS</b>  <b>Ref.: OR-148</b> (Ref.: NSK®: M154060)	1´10€

## REPUESTOS PARA MICROMOTORES W&H®

### Rotores compatibles Micromotores W&H®

RUMAR

	Descripción	Observaciones
	EB40  <b>Ref.: BVR-117</b> (Ref. W&H®: 04059300)	Incluye: disco teflón, arandelas y rodamientos.  <b>331<sup>80</sup>€</b>

### Escobillas compatibles Micromotores W&H®

RUMAR

	Descripción	Observaciones
	2,35 mm Perfecta (desde N/S 011117) <b>***Original W&amp;H***</b>  <b>Ref.: BVP-5500</b> (original, Ref W&H®: 03205500)	<b>74<sup>80</sup>€</b>

### Anillos tóricos compatibles micromotores W&H®

RUMAR

	Descripción	Observaciones
	Anillo tórico sistema INTRA todos los modelos / <b>TODAS LAS PRIMERAS MARCAS</b>  <b>Ref.: OR-148</b> (Ref.: W&H®: 08162300)	<b>1<sup>10</sup>€</b>

## REPUESTOS PARA MICROMOTORES BIEN AIR®

### Rotores compatibles Micromotores Bien Air®

RUMAR

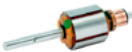
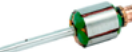
	Descripción	Observaciones
	MC3  150.00.42 / 211.75.29 + 701.01.71 + 1501036 = 1300082 + 1500042 + 1300086 + 1300081 // 701.01.71 + 21175.29 + 011.75.24 + 701.01.70  <b>Ref.: BVR-117</b> (Ref. Bien Air®: 21175.29 + 011.75.24 + 701.01.70)	Incluye: disco teflón, arandelas y rodamientos.  <b>331<sup>80</sup>€</b>
	MC2 40 IR  <b>Ref.: BVR-118</b> (Ref. Bien Air®: 1500932 / 211.36.04)	<b>348<sup>00</sup>€</b>
	MC2 40 LKE  <b>Ref.: BVR-119</b> (Ref. Bien Air®: 150.09.31 / 211.61.16)	<b>348<sup>00</sup>€</b>

### Escobillas Micromotores Bien Air®

RUMAR

	Descripción	Observaciones
	MC2 <b>***Original Bien Air***</b>  <b>Ref.: BVE-264/2</b> (Ref. Bien Air®: 211.45.06)	Pack 2 uds.  <b>63<sup>80</sup>€</b>
	MC3 <b>***Original Bien Air***</b>  <b>Ref.: BVE-265/2</b> (original, Ref. Bien Air®: 211.75.08)	Pack 2 uds.  <b>63<sup>80</sup>€</b>
	MC3 <b>***Compatible***</b>  <b>Ref.: BVE-268/2</b> (Ref. Bien Air®: 211.75.08)	Pack 2 uds.  <b>33<sup>80</sup>€</b>



Anillos tóricos compatibles micromotores **Bien Air®**

RUMAR

	Descripción	Observaciones
	Anillo tórico sistema INTRA todos los modelos / <b>TODAS LAS PRIMERAS MARCAS</b>  Ref.: <b>OR-148</b> (Ref.: Bien Air®: 1300967 / 705.02.91)	
		1'10€

Otros repuestos micromotores **Bien Air®**

RUMAR

	Descripción	Observaciones
	Pasador tope de arrastre MC2, Aquilón, clavija elástica 1x5 <b>***Original Bien Air***</b>  Ref.: <b>BVX-165</b> (Ref. Bien Air®: 652.02.02 / 1300664)	Medidas: 1x5 mm
		4'60€
	Pasador tope de arrastre MC3, clavija elástica <b>***Original Bien Air***</b>  Ref.: <b>BVX-166</b> (Ref. Bien Air®: 652.04.05)	Medidas: 1,5x4,7 mm
		4'80€

REPUESTOS PARA MICROMOTORES **SIRONA®**Anillos tóricos compatibles micromotores **Sirona®**



RUMAR

	Descripción	Observaciones
	Anillo tórico sistema INTRA todos los modelos / <b>TODAS LAS PRIMERAS MARCAS</b>  Ref.: <b>OR-148</b> (Ref.: Sirona®: 58.60.390)	
		1'10€

# REPUESTOS PARA MICROMOTORES MK-DENT®

## Rotores Micromotores MK-dent®



	Descripción	Observaciones
	MK-dent EM1190K (N/S<17000) <b>Ref.: BVR-RO1190MK</b>	338 <sup>00</sup> €
 <small>Imagen no disponible</small>	MK-dent EM1190K (N/S>17000) <b>Ref.: BVR-RO1190MK1</b>	364 <sup>80</sup> €

## Escobillas Micromotores MK-dent®



	Descripción	Observaciones
	EM1190K (Pack 2 uds) <b>Ref.: BVE-SP1219/2</b>	Pack 2 unidades 29 <sup>80</sup> €

## Anillos tóricos micromotores MK-dent®

RUMAR















	Descripción	Observaciones
	Anillo tórico sistema INTRA todos los modelos / <b>TODAS LAS PRIMERAS MARCAS</b> <b>Ref.: OR-148</b> (Ref.: MK-dent®: OR3011)	1 <sup>10</sup> €
	Anillo tórico EM1190K <b>Ref.: OR-SP1222</b>	1 Unidad 1 <sup>40</sup> €
 <small>Imagen no disponible</small>	Anillo tórico EM1190K <b>Ref.: OR-SP1228</b>	1 Unidad 1 <sup>30</sup> €
 <small>Imagen no disponible</small>	Anillo tórico EM1190K <b>Ref.: OR-SP1210</b>	1 Unidad 1 <sup>50</sup> €
 <small>Imagen no disponible</small>	Anillo tórico EM1190K <b>Ref.: OR-SP1214</b>	1 Unidad 1 <sup>40</sup> €







HASTA AGOTAR

HASTA AGOTAR

## Otros repuestos micromotores MK-dent®





	Descripción	Observaciones
 <small>Imagen no disponible</small>	Tapa EM1190K  <b>Ref.: BVX-SP1215</b>	4'20€  <b>HASTA AGOTAR</b>
 <small>Imagen no disponible</small>	Muelle EM1190K  <b>Ref.: BVX-SP1221</b>	1'50€  <b>HASTA AGOTAR</b>
	Anillo de regulación de agua AM1014, AM1016 y AM1116  <b>Ref.: BVX-SP1051</b>	27'80€  <b>HASTA AGOTAR</b>
	Anillo de regulación de aire AM1014, AM1016 y AM1116  <b>Ref.: BVX-SP1052</b>	32'80€  <b>HASTA AGOTAR</b>
 <small>Imagen no disponible</small>	Tapa tubo SP1059 del AM1014  <b>Ref.: BVX-SP1056</b>	6'90€  <b>HASTA AGOTAR</b>
 <small>Imagen no disponible</small>	Tubito de irrigación AM1014, AM1016 y AM1116  <b>Ref.: BVX-SP1059</b>	7'50€  <b>HASTA AGOTAR</b>
	Tapa roscada AM1014, AM1016 y AM1116  <b>Ref.: BVX-SP1060</b>	Llave Ref.: HE-2014  14'30€  <b>HASTA AGOTAR</b>
	Disco AM1014, AM1016 y AM1116  <b>Ref.: BVX-SP1061</b>	1'10€  <b>HASTA AGOTAR</b>
	Arandela AM1014, AM1016 y AM1116  <b>Ref.: BVX-SP1062</b>	1'80€  <b>HASTA AGOTAR</b>
	Bloque regulación AM1014  <b>Ref.: BVX-SP1063</b>	32'80€  <b>HASTA AGOTAR</b>
 <small>Imagen no disponible</small>	Muelle de presión regulador AM1014, AM1016 y AM1116  <b>Ref.: BVX-SP1064</b>	2'30€  <b>HASTA AGOTAR</b>
 <small>Imagen no disponible</small>	Regulador AM1014, AM1016 y AM1116  <b>Ref.: BVX-SP1065</b>	3'00€  <b>HASTA AGOTAR</b>
 <small>Imagen no disponible</small>	Perno plano AM1014, AM1016 y AM1116  <b>Ref.: BVX-SP1068</b>	3'90€  <b>HASTA AGOTAR</b>
	Cilindro exterior rotor AM1014, AM1016 y AM1116  <b>Ref.: BVX-SP1069</b>	42'90€  <b>HASTA AGOTAR</b>

	Descripción	Observaciones
	Funda protección AM1014, AM1016 y AM1116 <b>Ref.: BVX-SP1074</b>	59'60€ <b>HASTA AGOTAR</b>
	Tornillo AM1014, AM1016 y AM1116 <b>Ref.: BVX-SP1075</b>	5'80€ <b>HASTA AGOTAR</b>
 <small>Imagen no disponible</small>	Muelle de presión AM1014, AM1016 y AM1116 <b>Ref.: BVX-SP1079</b>	0'95€ <b>HASTA AGOTAR</b>
 <small>Imagen no disponible</small>	Pasador AM1014, AM1016 y AM1116 <b>Ref.: BVX-SP1080</b>	1'40€ <b>HASTA AGOTAR</b>
 <small>Imagen no disponible</small>	Cable goma AM1014 <b>Ref.: BVX-SP1082</b>	0'50€ <b>HASTA AGOTAR</b>
 <small>Imagen no disponible</small>	Cable goma AM1014 <b>Ref.: BVX-SP1083</b>	0'60€ <b>HASTA AGOTAR</b>
		Medidas: 1x4,5mm

## REPUESTOS PARA MICROMOTORES FARO®

### Escobillas Micromotores FARO®



	Descripción	Observaciones
	Única <b>Ref.: 80-406117</b> (Ref. Faro®: 556117)	1 unidad 31'80€
	Modo <b>Ref.: 80-407540/4</b> (Ref. Faro®: SP557540)	Pack 4 unidades 78'80€

## REPUESTOS PARA MICROMOTORES SAEYANG MARATHON®, SAESHIN®

### Rotores compatibles Micromotores Saeyang Marathon®, Saeshin®

RUMAR

	Descripción	Observaciones
	E Motor SDE-M33ES  <b>Ref.: BVR-120</b>	NO incluye rodamientos Ver: ROD-302 y ROD-354  <b>80'00.€</b>

### Escobillas Compatibles Micromotores Saeyang Marathon®, Saeshin®

RUMAR

	Descripción	Observaciones
	Marathon® Saeshin®  <b>Ref.: BVE-270/2</b>	Pack 2 uds  <b>20'80.€</b>

## REPUESTOS PARA MICROMOTORES MARATHON®

### Pinzas compatibles micromotores Marathon®

RUMAR

	Descripción	Observaciones
	2,35 mm Marathon®  <b>Ref.: BVP-406</b>	<b>29'80.€</b>
	2,35 mm Pinza para micromotor Saeshin®  <b>Ref.: BVP-410</b>	Forte 100 II Forte 103L Forte 107  <b>48'00.€</b>
	2,35 mm Pinza para micromotor Saeshin®  <b>Ref.: BVP-411</b>	Forte 100a III Forte 106 -ZO Forte 100  <b>48'00.€</b>
	2,35 mm Pinza para micromotor Saeshin®  <b>Ref.: BVP-412</b>	Forte 300 II Forte 300 III Forte 102 Forte 105L  <b>48'00.€</b>

Todos los rodamientos que ofrecemos están fabricados por los principales fabricantes de rodamientos a nivel mundial: **myonic**, **HQW-Barden**, **GRW**, **NMB**, **EZO** o **ESC**. Todos fabricados de acuerdo a las normas de precisión ISO\* (normas para rodamientos de dimensiones métricas) y ABEC\*\* (rodamientos generalmente en dimensiones de pulgadas).

\* ISO: International Standard Organization.

\*\* ABEC: Annular Bearing Engineers Conference.

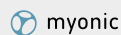

## RODAMIENTOS PARA MICROMOTORES KAVO®

### Rodamientos micromotores eléctricos KaVo® K190, K191, K192, K196 y K197

RUMAR

Modelos para KaVo®		Descripción
 	Delantero  <b>Ref.: ROD-0089</b> (Ref. KaVo®: 0.220.0089)	<b>Medidas:</b> 4x11x4mm Exterior: Liso Bola: Acero Retenedor: TN9 Sintético Abierto - Cerrado  <b>9'20€</b>
 	Trasero  <b>Ref.: ROD-0136</b> (Ref. KaVo®: 0.220.0136)	<b>Medidas:</b> 2x6x2,3mm Exterior: Liso Bola: Acero Retenedor: THB Phenolic Abierto - Cerrado  <b>12'80€</b>





### Rodamientos micromotores eléctricos KaVo® KL700

RUMAR

Modelos para KaVo®		Descripción
 	Delantero  <b>Ref.: ROD-200</b> (Ref. KaVo®: 0.220.0219)	<b>Medidas:</b> 5x11x5mm Exterior: Liso Bola: Acero Retenedor: Acero Cerrado - Cerrado  <b>12'80€</b>
 	Trasero  <b>Ref.: ROD-0218</b> (Ref. KaVo®: 0.220.0218)	<b>Medidas:</b> 3x8x3mm Exterior: Liso Bola: Acero Retenedor: Acero Cerrado - Cerrado  <b>11'80€</b>





### Rodamientos micromotores eléctricos KaVo® KL701

RUMAR

Modelos para KaVo®		Descripción
 	Delantero  <b>Ref.: ROD-7185</b> (Ref. KaVo®: 1.000.7185)	<b>Medidas:</b> 5x8x3mm Exterior: Liso Bola: Acero Retenedor: Acero Cerrado - Cerrado  <b>16'80€</b>
 	Trasero  <b>Ref.: ROD-0218</b> (Ref. KaVo®: 0.220.0218)	<b>Medidas:</b> 3x8x3mm Exterior: Liso Bola: Acero Retenedor: Acero Cerrado - Cerrado  <b>11'80€</b>

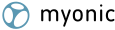











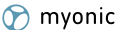

## Rodamientos micromotores eléctricos KaVo® K200

RUMAR

Modelos para KaVo®		Descripción
 	Delantero  <b>Ref.: ROD-7185</b> (Ref. KaVo®: 1.000.7185)	<b>Medidas:</b> 5x8x3mm Exterior: Liso Bola: Acero Retenedor: Acero Cerrado - Cerrado  <b>16'80€</b>
  	Trasero  <b>Ref.: ROD-0136</b> (Ref. KaVo®: 0.220.0136)	<b>Medidas:</b> 2x6x2,3mm Exterior: Liso Bola: Acero Retenedor: THB Phenolic Abierto - Cerrado  <b>12'80€</b>







## Rodamientos micromotores eléctricos KaVo® K9 antiguo (K9 EWL 950 / 955)

RUMAR

Modelos para KaVo®		Descripción
  	Delantero inducido  <b>Ref.: ROD-2157</b> (Ref. KaVo®: 0.220.0157)	<b>Medidas:</b> 4x11x4mm Exterior: Liso Bola: Acero Retenedor: Acero Cerrado - Cerrado  <b>14'80€</b>
 	Trasero inducido  <b>Ref.: ROD-2158</b> (Ref. KaVo®: 0.220.0158)	<b>Medidas:</b> 2x6x2,3mm Exterior: Liso Bola: Acero Retenedor: Acero Cerrado - Cerrado  <b>15'80€</b>
  	Eje K9 EWL 950 Trasero Eje K9 EWL 955  <b>Ref.: ROD-2113</b> (Ref. KaVo®: 0.220.0113)	<b>Medidas:</b> 8x16x6mm Exterior: Liso Bola: Acero Retenedor: TN9 Sintético Cerrado - Cerrado  <b>11'80€</b>
  	Delantero eje K9 EWL 955  <b>Ref.: ROD-2148</b> (Ref. KaVo®: 0.220.0148)	<b>Medidas:</b> 8x14x4mm <b>Velocidad:</b> 20.000 rpm Exterior: Liso Bola: Acero Retenedor: TN9 Sintético Cerrado - Cerrado  <b>13'80€</b>
   	Kit 2 rodamientos inducido: 30-2157 + 30-2158  <b>Ref.: ROD-2011</b>	<b>24'60€</b>

## Rodamientos micromotores eléctricos KaVo® K9 (azul) (K9 EWL 4930 / 4932 / 4933)





RUMAR

Modelos para KaVo®		Descripción
 HAW BARDEN	Delantero inducido  Ref.: <b>ROD-2223</b> (Ref. KaVo®: 0.220.0223)	<b>Medidas:</b> 5x11x4mm Exterior: Liso Bola: Acero Retenedor: Acero Cerrado - Cerrado  <b>13'80€</b>
 myonic	Trasero inducido  Ref.: <b>ROD-2158</b> (Ref. KaVo®: 0.220.0158)	<b>Medidas:</b> 2x6x2,3mm Exterior: Liso Bola: Acero Retenedor: Acero Cerrado - Cerrado  <b>15'80€</b>
 HAW BARDEN	Delantero eje  Ref.: <b>ROD-2055</b> (Ref. KaVo®: 0.220.0055)	<b>Medidas:</b> 7x14x1x7,5mm Exterior: Liso Bola: Acero Retenedor: TN9 Sintético Cerrado - Cerrado  <b>45'80€</b>
 myonic	Trasero eje  Ref.: <b>ROD-2044</b> (Ref. KaVo®: 0.220.0044)	<b>Medidas:</b> 7,85x15,89x5,98mm Exterior: Liso Bola: Acero Retenedor: TN9 Sintético Cerrado - Cerrado  <b>26'80€</b>
 myonic + HAW BARDEN	Kit 2 rodamientos inducido: 30-2223 + 30-2158  Ref.: <b>ROD-2111</b>	<b>24'80€</b>
 myonic + HAW BARDEN	Kit 2 rodamientos eje: 30-2055 + 30-2044  Ref.: <b>ROD-2112</b>	<b>65'80€</b>

## Rodamientos micromotores eléctricos KaVo® K10











RUMAR

Modelos para KaVo®		Descripción
 HAW BARDEN	Delantero inducido  Ref.: <b>ROD-2779</b> (Ref. KaVo®: 0.220.0779)	<b>Medidas:</b> 4x11x4mm Exterior: Liso Bola: Acero Retenedor: TN9 Sintético Cerrado - Cerrado  <b>15'80€</b>
 HAW BARDEN	Trasero inducido  Ref.: <b>ROD-2778</b> (Ref. KaVo®: 0.220.0778)	<b>Medidas:</b> 3x8x4mm Exterior: Liso Bola: Acero Retenedor: TN9 Sintético Cerrado - Cerrado  <b>18'80€</b>
 HAW BARDEN	Eje K10  Ref.: <b>ROD-2113</b> (Ref. KaVo®: 0.220.0113)	<b>Medidas:</b> 8x16x6mm Exterior: Liso Bola: Acero Retenedor: TN9 Sintético Cerrado - Cerrado  <b>11'80€</b>

Modelos para KaVo®		Descripción
 	Kit 2 rodamientos inducido: 30-2778 + 30-2779  <b>Ref.: ROD-2021</b>	<b>32'50€</b>
 	Kit 2 rodamientos eje: 2X 30-2113  <b>Ref.: ROD-2000</b>	<b>19'30€</b>

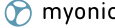
## Rodamientos micromotores eléctricos KaVo® K11







RUMAR

Modelos para KaVo®		Descripción
 	Trasero inducido  <b>Ref.: ROD-2778</b> (Ref. KaVo®: 0.220.0778)	<b>Medidas:</b> 3x8x4mm Exterior: Liso Bola: Acero Retenedor: TN9 Sintético Cerrado - Cerrado
 	Delantero inducido  <b>Ref.: ROD-2779</b> (Ref. KaVo®: 0.220.0779)	<b>Medidas:</b> 4x11x4mm Exterior: Liso Bola: Acero Retenedor: TN9 Sintético Cerrado - Cerrado
 	Delantero eje  <b>Ref.: ROD-2045</b> (Ref. KaVo®: 0.220.0045)	<b>Medidas:</b> 7,85x15,89x7,5mm Exterior: Liso Bola: Acero Retenedor: TN9 Sintético Abierto - Cerrado
 	Trasero eje  <b>Ref.: ROD-2044</b> (Ref. KaVo®: 0.220.0044)	<b>Medidas:</b> 7,85x15,89x5,98mm Exterior: Liso Bola: Acero Retenedor: TN9 Sintético Cerrado - Cerrado
 	Kit 2 rodamientos inducido: 30-2778 + 30-2779  <b>Ref.: ROD-2021</b>	<b>32'50€</b>
 	Kit 2 rodamientos eje: 30-2045 + 30-2044  <b>Ref.: ROD-2031</b>	<b>92'30€</b>

**Kit Ref. KaVo 0.674.2841:**  
 0.200.0827 + 0.220.0045 + 2X0.222.4042 + 0.220.0044 = 0.200.0827 + ROD-2045 + 2X0.222.4042 + ROD-2044

## Rodamientos micromotores eléctricos KaVo® K12 / Power Grip todos los modelos

RUMAR

Modelos para KaVo®		Descripción
 HAW BARDEN	Delantero inducido <b>Ref.: ROD-2779</b> (Ref. KaVo: 0.220.0779)	<b>Medidas:</b> 4x11x4mm Exterior: Liso Bola: Acero Retenedor: TN9 Sintético Cerrado - Cerrado <b>15'80€</b>
 HAW BARDEN	Trasero inducido <b>Ref.: ROD-2778</b> (Ref. KaVo®: 0.220.0778)	<b>Medidas:</b> 3x8x4mm Exterior: Liso Bola: Acero Retenedor: TN9 Sintético Cerrado - Cerrado <b>18'80€</b>
 HAW BARDEN	Delantero eje <b>Ref.: ROD-2055</b> (Ref. KaVo®: 0.220.0055)	<b>Medidas:</b> 7x14x1x7,5mm Exterior: Liso Bola: Acero Retenedor: TN9 Sintético Cerrado - Cerrado <b>45'80€</b>
 myonic	Trasero eje <b>Ref.: ROD-2044</b> (Ref. KaVo®: 0.220.0044)	<b>Medidas:</b> 7,85x15,89x5,98mm Exterior: Liso Bola: Acero Retenedor: TN9 Sintético Cerrado - Cerrado <b>26'80€</b>
 HAW BARDEN	Kit 2 rodamientos inducido: 30-2778 + 30-2779 <b>Ref.: ROD-2021</b>	<b>32'50€</b>
 myonic + HAW BARDEN	Kit 2 rodamientos eje: 30-2055 + 30-2044 <b>Ref.: ROD-2112</b>	<b>65'80€</b>



## Rodamientos micromotores eléctricos KaVo® K4 / K5

RUMAR

Modelos para KaVo®		Descripción
 HAW BARDEN	Delantero <b>Ref.: ROD-2058</b> (Ref. KaVo®: 0.220.0058 + 2x0.200.6199 + 0.200.0692)	<b>Medidas:</b> 7x14x1x7,5mm <b>Incluye:</b> Tóricos y fieltro <b>Especial</b> Exterior: Liso Bola: Acero Retenedor: TN9 Sintético Cerrado - Cerrado <b>62'80€</b>
 HAW BARDEN	Trasero <b>Ref.: ROD-2056</b> (Ref. KaVo®: 0.220.0056)	<b>Medidas:</b> 10x19x7mm Exterior: Liso Bola: Acero Retenedor: TN9 Sintético Cerrado - Cerrado <b>21'80€</b>
 HAW BARDEN	Kit 2 rodamientos inducido: 30-2056 + 30-2058 <b>Ref.: ROD-2050</b>	<b>80'80€</b>

## Rodamientos micromotores eléctricos KaVo® SF EWL 4004 / 4005

RUMAR

Modelos para KaVo®		Descripción
 	Rodamiento delantero  <b>Ref.: ROD-6057</b> (Ref. KaVo®: 0.247.6057)	<b>Medidas:</b> 8x22x7mm Exterior: Liso Bola: Acero Retenedor: THB Phenolic Abierto - Cerrado  <b>18´90€</b>
 	Rodamiento trasero  <b>Ref.: ROD-0112</b> (Ref. KaVo®: 0.220.0112)	<b>Medidas:</b> 7x14x5mm Exterior: Liso Bola: Acero Retenedor: TN9 Sintético Abierto - Cerrado  <b>25´80€</b>

## Rodamientos micromotores neumáticos KaVo®







RUMAR

Modelos para KaVo®		Descripción
 	181M  <b>Ref.: ROD-310</b> (Ref. KaVo®: 0.220.0021)	<b>Medidas:</b> 3x7x2mm Exterior: Liso Bola: Acero Retenedor: Bronce Abierto-Abierto  <b>24´80€</b>

## RODAMIENTOS PARA MICROMOTORES NSK®

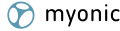

## Rodamientos micromotores eléctricos NSK® ULTIMATE, VOLVERE Y UHR

RUMAR

Modelos para NSK®		Descripción
 	Trasero eje  <b>Ref.: ROD-220</b> (Ref. NSK®: B11243-1306)	<b>Medidas:</b> 6X13x5mm Exterior: Liso Bola: Acero Retenedor: TN9 Sintético Cerrado - Cerrado  <b>9´80€</b>
 	Delantero eje  <b>Ref.: ROD-221</b> (Ref. NSK®: B20245-2763)	<b>Medidas:</b> 6,35X12,7X4,763mm Exterior: Liso Bola: Acero Retenedor: TN9 Sintético Cerrado - Cerrado  <b>17´60€</b>
 	Volvere rotor  <b>Ref.: ROD-683</b>	<b>Medidas:</b> 3x7x3mm Exterior: Liso Bola: Acero Retenedor: Acero Cerrado - Cerrado  <b>14´80€</b>
 	Ultimate rotor  <b>Ref.: ROD-327</b>	<b>Medidas:</b> 4x9x4mm Exterior: Liso Bola: Acero Retenedor: TN9 Sintético Cerrado - Cerrado  <b>14´80€</b>

## Rodamientos micromotores neumáticos NSK®







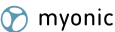

RUMAR

Modelos para NSK®		Descripción
	EX103 EX203 MX200 EX100	IS205 TI205 PTL950TI TI205L
	EX203C	<b>Medidas:</b> 2,38x7,938x3,571mm Exterior: Liso Bola: Acero Retenedor: Acero Cerrado-Cerrado
	<b>Ref.: ROD-311</b> (Ref. NSK®: B22227-7923)	<b>14'60€</b>

## RODAMIENTOS PARA MICROMOTORES W&amp;H®



## Rodamientos micromotores eléctricos W&amp;H®

RUMAR

Modelos para W&H®		Descripción
	Delantero inducido MF Techtorque Delantero inducido MF Perfecta	<b>Medidas:</b> 5x11x5mm <b>Especial</b> Exterior: Liso Bola: Acero Retenedor: Acero Cerrado - Cerrado
	<b>Ref.: ROD-200</b> (Ref. W&H®: 02685500)	<b>12'80€</b>
	Trasero inducido MF Techtorque Trasero inducido MF Perfecta	<b>Medidas:</b> 3x8x4mm Exterior: Liso Bola: Acero Retenedor: TN9 Sintético Cerrado - Cerrado
	<b>Ref.: ROD-2778</b> (Ref. W&H®: 01206200)	<b>18'80€</b>
	Delantero pieza de mano azul / negra MF Techtorque Delantero pieza de mano azul / negra MF Perfecta	<b>Medidas:</b> 8x16x6mm Exterior: Liso Bola: Acero Retenedor: TN9 Sintético Cerrado - Cerrado
	<b>Ref.: ROD-2113</b> (Ref. W&H®: 03202300)	<b>11'80€</b>
	Trasero pieza de mano azul / negra MF Techtorque Trasero pieza de mano azul / negra MF Perfecta	<b>Medidas:</b> 7x14x5mm Exterior: Liso Bola: Acero Retenedor: TN9 Sintético Cerrado - Cerrado
	<b>Ref.: ROD-203</b> (Ref. W&H®: 03202200)	<b>19'50€</b>
	Perfecta 300	<b>Medidas:</b> 4x9x4mm Exterior: Liso Bola: Acero Retenedor: TN9 Sintético Cerrado - Cerrado
	<b>Ref.: ROD-327</b>	<b>14'80€</b>

## Rodamientos micromotores neumáticos W&amp;H®

RUMAR

Modelos para W&H®		Descripción
	A25 E25 LT25	<b>Medidas:</b> 3,175x7,938x3,571mm Exterior: Liso Bola: Acero Retenedor: Acero Cerrado-Cerrado
	<b>Ref.: ROD-133</b> (Ref. W&H®: 01850600)	<b>12'20€</b>

## RODAMIENTOS PARA MICROMOTORES BIEN AIR®

### Rodamientos micromotores eléctricos Bien Air® MC3

RUMAR

Modelos para Bien Air®		Descripción
  	Delantero  <b>Ref.: ROD-130</b> (Ref. Bien Air®: 701.01.71 / 1300082)	<b>Medidas:</b> 4x11x4mm Exterior: Liso Bola: Acero Retenedor: Acero Cerrado - Cerrado  <b>15´20€</b>
  	Trasero  <b>Ref.: ROD-131</b> (Ref. Bien Air®: 701.01.70 / 1300081)	<b>Medidas:</b> 2,38x7,938x3,571mm Exterior: Liso Bola: Acero Retenedor: Acero Cerrado - Cerrado  <b>16´40€</b>



### Rodamientos micromotores eléctricos Bien Air® MC2

RUMAR

Modelos para Bien Air®		Descripción
  	Trasero (Excepto Aquilón)  <b>Ref.: ROD-132</b> (Ref. Bien Air®: 701.01.23 / 1301107)	<b>Medidas:</b> 2,38x7,938x9,05x3,571mm Exterior: Con reborde Bola: Acero Retenedor: Acero Cerrado - Cerrado  <b>15´50€</b>
  	Delantero Aquilón (delantero y trasero)  <b>Ref.: ROD-133</b> (Ref. Bien Air®: 701.01.14 / 1300985)	<b>Medidas:</b> 3,175x7,938x3,571mm Exterior: Liso Bola: Acero Retenedor: Acero Cerrado - Cerrado  <b>16´80€</b>

### Rodamientos micromotores eléctricos Bien Air® MX





RUMAR

Modelos para Bien Air® MX		Descripción
 	Delantero  <b>Ref.: ROD-134</b> (Ref. Bien Air®: 701.01.93)	<b>Medidas:</b> 4,763x7,938x3,175mm Exterior: Liso Bola: Acero Retenedor: Acero Cerrado - Cerrado  <b>14´80€</b>
 	Trasero  <b>Ref.: ROD-135</b> (Ref. Bien Air®: 701.01.94)	<b>Medidas:</b> 3,967x7,938x3,175mm Exterior: Liso Bola: Acero Retenedor: Acero Cerrado - Cerrado  <b>14´80€</b>

## RODAMIENTOS PARA MICROMOTORES SIRONA®

Rodamientos micromotores eléctricos Sirona®

RUMAR

Modelos para Sirona®		Descripción
 	SLI, delantero  <b>Ref.: ROD-350</b> (Ref. Sirona®: 7040801)	<b>Medidas:</b> 4x9x4mm Exterior: Con reborde Bola: Acero Retenedor: Acero Cerrado - Cerrado  <b>12'90€</b>
 	SLI, trasero  <b>Ref.: ROD-351</b> (Ref. Sirona®: 7036130)	<b>Medidas:</b> 2x6x2,3mm Exterior: Con reborde Bola: Acero Retenedor: Acero Cerrado - Cerrado  <b>19'50€</b>

## RODAMIENTOS PARA MICROMOTORES MK-DENT®

Rodamientos micromotores neumáticos MK-dent®



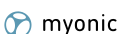









RUMAR

Modelos para MK-dent®		Descripción
 	AM1014  <b>Ref.: ROD-310</b>	<b>Medidas:</b> 3x7x2mm Exterior: Liso Bola: Acero Retenedor: Bronce Abierto-Abierto  <b>24'80€</b>

# RODAMIENTOS PARA MICROMOTORES SAEYANG MARATHON®

Rodamientos micromotores eléctricos **SAEYANG MARATHON®**













RUMAR

Modelos para Saeyang Marathon®			Descripción
 	H20 H35SP1 H37L1 SH37L1	H37LN H37(L)SP H35LS M45	SH20N (30K) H300 (Ø3)  <b>Medidas:</b> 6x12x4mm Exterior: Liso Bola: Acero Retenedor: TN9 Sintético Cerrado - Cerrado
<b>Ref.: ROD-233</b> (Ref. Marathon®: 1260ZZ)  <b>17'80€</b>			
 	Eje trasero H20 Eje trasero H200 (12V) Eje trasero H200 (30V) Eje trasero H35SP1 Eje trasero H37L1	Eje trasero SH37L1 Eje trasero H37LN Eje trasero H37(L) SP Eje trasero H35LS Eje trasero M45	Eje trasero SH20N(30K) Eje trasero SH37LN Eje trasero MH20 (12V) Eje trasero MH24 (24V) Eje trasero H300 (Ø3)  <b>Medidas:</b> 8x14x4mm <b>Velocidad:</b> 45.000 rpm Exterior: Liso Bola: Acero Retenedor: TN9 Sintético Cerrado - Cerrado
<b>Ref.: ROD-234</b> (Ref. Marathon®: 1480ZZ)  <b>9'80€</b>			
 	SH37LN SH40C BM50S1	BM50K BSS0C BM40S1	BM40C BHS1 BHK  <b>Medidas:</b> 6x13x5mm Exterior: Liso Bola: Acero Retenedor: TN9 Sintético Cerrado - Cerrado
<b>Ref.: ROD-220</b> (Ref. Marathon®: 1360ZZ)  <b>9'80€</b>			
 	Delantero M20ES Delantero M25ES Delantero M33E Delantero M33ES Delantero M40ES Delantero H20 Delantero H200 (12V)	Delantero H200 (30V) Delantero H35SP1 Delantero H37L1 Delantero SH37L1 Delantero H37LN Delantero H37(L) SP Delantero H35LS	Delantero M45 Delantero SH20N (30K) Delantero SH37LN Delantero SH40C  <b>Medidas:</b> 3x10x4mm Exterior: Liso Bola: Acero Retenedor: Acero Abierto - Abierto
<b>Ref.: ROD-302</b> (Ref. Marathon®: 1030ZZ)  <b>12'20€</b>			
 	Trasero M20ES Trasero M25ES Trasero M33ES Trasero M40ES	Trasero H20 Trasero H200 (12V) Trasero H200 (30V) Trasero H37LN	Trasero H37(L) SP Trasero H35LS  <b>Medidas:</b> 3x8x4mm Exterior: Liso Bola: Acero Retenedor: TN9 Sintético Cerrado - Cerrado
<b>Ref.: ROD-354</b> (Ref. Marathon®: 830ZZ)  <b>9'80€</b>			
 	Delantero eje BH50		<b>Medidas:</b> 6,35X12,7X4,763mm Exterior: Liso Bola: Acero Retenedor: TN9 Sintético Cerrado - Cerrado
<b>Ref.: ROD-221</b>  <b>17'60€</b>			

# RODAMIENTOS PARA MICROMOTORES SAESHIN®

Rodamientos micromotores eléctricos SAESHIN®

RUMAR

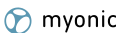
Modelos para SAESHIN®		Descripción
  	Inducido  <b>Ref.: ROD-354</b> (Ref. Saeshin®: 830ZZ)	<b>Medidas:</b> 3x8x4mm Exterior: Liso Bola: Acero Retenedor: TN9 Sintético Cerrado - Cerrado  <b>9'80€</b>
  	Inducido  <b>Ref.: ROD-355</b> (Ref. Saeshin®: 940ZZ)	<b>Medidas:</b> 4x9x4mm Exterior: Liso Bola: Acero Retenedor: TN9 Sintético Cerrado - Cerrado  <b>9'80€</b>
  	Eje  <b>Ref.: ROD-356</b> (Ref. Saeshin®: 1050ZZ)	<b>Medidas:</b> 5x10x4mm Exterior: Liso Bola: Acero Retenedor: TN9 Sintético Cerrado - Cerrado  <b>9'80€</b>
  	Eje  <b>Ref.: ROD-357</b> (Ref. Saeshin®: 1370ZZ)	<b>Medidas:</b> 7x13x4mm Exterior: Liso Bola: Acero Retenedor: TN9 Sintético Cerrado - Cerrado  <b>9'80€</b>
 	Eje  <b>Ref.: ROD-234</b> (Ref. Saeshin®: 1480ZZ)	<b>Medidas:</b> 8x14x4mm Exterior: Liso Bola: Acero Retenedor: TN9 Sintético Cerrado - Cerrado  <b>9'80€</b>



RFE

## ▶ REPUESTOS PARA SILLONES FEDESA®

- Filtros para sillones Fedesa®
- Botoneras para sillones Fedesa®
- Válvulas, electroválvulas y otros para sillones Fedesa®
- Muelles para sillones Fedesa®
- Motores elevadores para sillones Fedesa®
- Varios repuestos para sillones Fedesa®
- Pistones para sillones Fedesa®

... hasta aquí los repuestos específicos para sillones Fedesa®,  
para **+ REPUESTOS SILLONES FEDESA®** :

**+ REPUESTOS SILLONES FEDESA®**

**Ver Sección**



- |   |  |
|---|--|
| ▶ <b>Mangueras sillones Fedesa®</b> .....   | Mangueras equipo                       |
| ▶ <b>Repuestos lámparas sillones Fedesa®</b> .....  | Repuestos lámparas Faro®               |
| ▶ <b>Jeringas y repuestos jeringas sillones Fedesa®</b> .....                                 | Jeringas y repuestos jeringas          |
| ▶ <b>Válvulas sillones Fedesa®</b> .....  | Válvulas y electroválvulas             |
| ▶ <b>Filtros, mangueras, terminales y otros sistemas de aspiración sillones Fedesa®</b> ..... | Sistemas de aspiración y sus repuestos |
| ▶ <b>Reguladores de presión sillones Fedesa®</b> .....  | Reguladores de presión                 |
| ▶ <b>Racores, conectores y espigas sillones Fedesa®</b> .....                                 | Racores, conectores y espigas          |
| ▶ <b>Pedales sillones Fedesa®</b> .....   | Pedales y sus repuestos                |

PRÓXIMAMENTE NUEVAS REFERENCIAS ¡CONSÚLTANOS!

## FILTROS PARA SILLONES FEDESA®

Filtros para sillones Fedesa®

RUMAR











	Descripción	Observaciones
	Filtro amarillo Dürr® Aspiraciones ***Original Dürr®***  Ref.: <b>68-37001</b> (Ref. Dürr®: 0725.041.00)	Pack 12 uds. Utilizado en la mayoría de los sillones Fedesa®  40'80€
	Filtro sólidos aspiraciones Cattani® ***Original Cattani®***  Ref.: <b>38-1055</b> (Ref. Cattani®: 1041055   Ref. Fedesa®: F034A91)	Pack 1 ud. Utilizado en algunos de los sillones Fedesa®  15'20€

Mangueras, terminales de aspiración y relacionados sillones Fedesa®  
Ver sección: Sistemas de aspiración y sus repuestos







## BOTONERAS PARA SILLONES FEDESA®

Botoneras para sillones Fedesa®

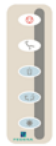
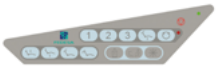
RUMAR

	Descripción	Observaciones
<b>NUEVO</b>	 Botonera digital bandeja genérica para sillones Fedesa® Arco  Ref.: <b>FED-082A94</b> (Ref. Fedesa®: 082A94)	 70'80€* ▶ *Sin descuento
<b>NUEVO</b>	 Kit botoneras bandeja + auxiliar para sillones Fedesa® Astral  Ref.: <b>FED-KITASTRAL</b> (Ref. Fedesa®: 082A91V + 082A94V)	 109'80€* ▶ *Sin descuento
<b>NUEVO</b>	 Botonera digital soporte cánulas para sillones Fedesa®  Ref.: <b>FED-082A91A</b> (Ref. Fedesa®: 082A91A)	 42'80€* ▶ *Sin descuento <b>BAJO PEDIDO</b>
<b>NUEVO</b>	 Botonera bandeja Astral para sillones Fedesa®  Ref.: <b>FED-082A94V</b> (Ref. Fedesa®: 082A94V)	 88'00€* ▶ *Sin descuento <b>BAJO PEDIDO</b>
<b>NUEVO</b>	 Botonera auxiliar Astral para sillones Fedesa®  Ref.: <b>FED-082A91V</b> (Ref. Fedesa®: 082A91V)	 44'80€* ▶ *Sin descuento <b>BAJO PEDIDO</b>

OTRAS BOTONERAS FEDESA ¡CONSÚLTANOS!

	Descripción	Observaciones
NUEVO	 <p>Botonera digital Fedesa® JS500</p> <p>Ref.: <b>FED-082A61</b> (Ref. Fedesa®: <b>082A61</b>)</p>	<p>Compatible con Ref. Fedesa® 082A71</p> <p><b>73</b> 80€* ▶*Sin descuento</p>
NUEVO	 <p>Botonera digital cánulas Fedesa® JS500</p> <p>Ref.: <b>FED-082A62</b> (Ref. Fedesa®: 082A62)</p>	<p>Compatible con Ref. Fedesa® 082A70 (mod)</p> <p><b>42</b> 80€* ▶*Sin descuento</p>
NUEVO	 <p>Botonera para sillones Fedesa®</p> <p>Ref.: <b>FED-082A39</b> (Ref. Fedesa®: 082A39)</p>	<p><b>76</b> 80€* ▶*Sin descuento</p>
NUEVO	 <p>Botonera para sillones Fedesa®</p> <p>Ref.: <b>FED-082A50</b> (Ref. Fedesa®: 082A50)</p>	<p><b>74</b> 80€* ▶*Sin descuento <b>BAJO PEDIDO</b></p>
NUEVO	 <p>Botonera para sillones Fedesa®</p> <p>Ref.: <b>FED-082A93</b> (Ref. Fedesa®: 082A93)</p>	<p><b>99</b> 80€* ▶*Sin descuento <b>BAJO PEDIDO</b></p>
	 <p>Botonera digital bandeja JS250 para sillones Fedesa®</p> <p>Ref.: <b>FED-082A63</b> (Ref. Fedesa®: 082A63)</p>	<p><b>51</b> 80€* ▶*Sin descuento</p>
	 <p>Botonera soporte cánulas JS250 para sillones Fedesa®</p> <p>Ref.: <b>FED-082A64</b> (Ref. Fedesa®: 082A64)</p>	<p><b>26</b> 80€* ▶*Sin descuento</p>
	 <p>Botonera bandeja Astral para sillones Fedesa®</p> <p>Ref.: <b>FED-082A90</b> (Ref. Fedesa®: 082A90)</p>	<p><b>40</b> 80€* ▶*Sin descuento</p>
	 <p>Botonera digital soporte cánulas Astral para sillones Fedesa®</p> <p>Ref.: <b>FED-082A91</b> (Ref. Fedesa®: 082A91)</p>	<p><b>25</b> 80€* ▶*Sin descuento</p>

**OTRAS BOTONERAS FEDESA ¡CONSÚLTANOS!**

PARA TODAS LAS BOTONERAS QUE **NO** APARECEN COMO **En Stock**









**¡CONSÚLTANOS!**

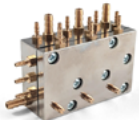
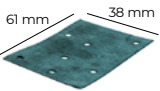







# VÁLVULAS, ELECTROVÁLVULAS Y OTROS PARA SILLONES FEDESA®

Válvulas, electroválvulas y otros para sillones Fedesa®

RUMAR





	Descripción	Observaciones
	<p>Grupo distribuidor 3 instrumentos equipos Fedesa®</p> <p><b>Ref.: FED-317A04</b> (Ref. Fedesa®: 317A04)</p>	<p>Repuesto relacionado: FED-317A02</p> <p><b>98'00€*</b></p> <p>▶ *Sin descuento</p>
 <p>61 mm 38 mm</p>	<p>Membrana bloque Fedesa® (Ref.: FED-317A04) 3 instrumentos</p> <p><b>Ref.: FED-317A02</b> (Ref. Fedesa®: 317A02)</p>	<p><b>14'80€</b></p>
	<p>Bloque 2 electroválvulas</p> <p><b>Ref.: FED-054A05</b> (Ref. Fedesa®: 054A05)</p>	<p><b>80'00€*</b></p> <p>▶ *Sin descuento</p> <p><b>Voltaje:</b> 24 V AC 50 Hz Repuestos relacionados: FED-237A12 y FED-237A03</p>
	<p>Bobina 5VA</p> <p><b>Ref.: FED-237A14</b> (Ref. Fedesa®: 237A14)</p>	<p><b>12'80€*</b></p> <p>▶ *Sin descuento</p> <p><b>Diámetro:</b> 9 mm <b>Voltaje:</b> 24 V AC Repuesto para bloque Fedesa Ref.: 054A04</p>
	<p>Bobina 7,5VA con núcleo</p> <p><b>Ref.: FED-237A03</b> (Ref. Fedesa®: 237A03)</p>	<p><b>32'80€*</b></p> <p>▶ *Sin descuento</p> <p><b>Voltaje:</b> 24 V AC Repuesto para bloque Fedesa Ref.: 054A05</p>
	<p>Núcleo + guía latón EV agua</p> <p><b>Ref.: FED-237A12</b> (Ref. Fedesa®: 237A12)</p>	<p><b>18'80€*</b></p> <p>▶ *Sin descuento</p> <p>Repuesto para bloque Fedesa Ref.: 054A05</p>
	<p>Conjunto 24 V AC</p> <p><b>Ref.: FED-054A04</b> (Ref. Fedesa®: 054A04)</p>	<p><b>23'80€*</b></p> <p>▶ *Sin descuento</p> <p>Repuesto relacionado: FED-237A14</p>
	<p>Placa conexión 28 con junta</p> <p><b>Ref.: FED-185A65</b> (Ref. Fedesa®: 185A65)</p>	<p><b>28'80€*</b></p> <p>▶ *Sin descuento</p>
	<p>Membrana placa conexión Fedesa® (FED-185A65)</p> <p><b>Ref.: FED-4101K03</b> (Ref. Fedesa®: 4101K03)</p>	<p><b>2'80€*</b></p> <p>▶ *Sin descuento</p>











	Descripción		Observaciones
	Filtro bronce  <b>Ref.: FED-275A09</b> (Ref. Fedesa®: 275A09)	 2'80€*	*Sin descuento
	Unión 6mm macho x 1/8" macho Especial Fedesa®  <b>Ref.: FED-575A70</b> (Ref. Fedesa®: 575A70)	 0'80€*	*Sin descuento
	"T" Intermedias 6 x 6 x 6 mm Especial Fedesa®  <b>Ref.: FED-575A55</b> (Ref. Fedesa®: 575A55)	 0'90€*	*Sin descuento

## MUELLES PARA SILLONES FEDESA®

Muelles para sillones Fedesa®

RUMAR

	Descripción		Observaciones
	Muelle Fedesa®  <b>Ref.: FED-440A01</b> (Ref. Fedesa®: 440A01)	6'00€	
	Muelle Fedesa®  <b>Ref.: FED-440A03</b> (Ref. Fedesa®: 440A03)	7'00€	
	Muelle Fedesa®  <b>Ref.: FED-440A05</b> (Ref. Fedesa®: 440A05)	11'80€	
	Muelle Fedesa®  <b>Ref.: FED-440A06</b> (Ref. Fedesa®: 440A06)	6'00€	
	Muelle Fedesa®  <b>Ref.: FED-440A09</b> (Ref. Fedesa®: 440A09)	16'80€	



	Descripción	Observaciones
	<p>Muelle Fedesa®</p> <p><b>Ref.: FED-440A13</b> (Ref. Fedesa®: 440A13)</p>	15'80€
	<p>Muelle Fedesa®</p> <p><b>Ref.: FED-440A13-1</b> (Ref. Fedesa®: 440A13-1)</p>	15'80€
	<p>Muelle Fedesa®</p> <p><b>Ref.: FED-440A18</b> (Ref. Fedesa®: 440A18)</p>	6'30€
	<p>Muelle Fedesa®</p> <p><b>Ref.: FED-440A20</b> (Ref. Fedesa®: 440A20)</p>	6'80€
	<p>Muelle Fedesa®</p> <p><b>Ref.: FED-440A21</b> (Ref. Fedesa®: 440A21)</p>	5'80€
	<p>Muelle Fedesa®</p> <p><b>Ref.: FED-440A23</b> (Ref. Fedesa®: 440A23)</p>	15'80€
	<p>Muelle Fedesa®</p> <p><b>Ref.: FED-440A28</b> (Ref. Fedesa®: 440A28)</p>	13'80€
	<p>Muelle Fedesa®</p> <p><b>Ref.: FED-440A29</b> (Ref. Fedesa®: 440A29)</p>	15'80€
	<p>Muelle Fedesa®</p> <p><b>Ref.: FED-440A29-1</b> (Ref. Fedesa®: 440A29-1)</p>	15'80€
	<p>Muelle Fedesa®</p> <p><b>Ref.: FED-440A33</b> (Ref. Fedesa®: 440A33)</p>	16'80€

	Descripción	Observaciones
	Muelle Fedesa®  <b>Ref.: FED-440A34</b> (Ref. Fedesa®: 440A34)	<b>16'80€</b>
	Muelle Fedesa®  <b>Ref.: FED-440A38</b> (Ref. Fedesa®: 440A38)	<b>19'60€</b>
	Muelle Fedesa®  <b>Ref.: FED-440A39</b> (Ref. Fedesa®: 440A39)	<b>16'80€</b>
	Muelle Fedesa®  <b>Ref.: FED-440A41</b> (Ref. Fedesa®: 440A41)	<b>15'80€</b>
	Muelle Fedesa®  <b>Ref.: FED-440A64</b> (Ref. Fedesa®: 440A64)	<b>16'80€</b>
	Muelle Fedesa®  <b>Ref.: FED-440B06</b> (Ref. Fedesa®: 440B06)	<b>15'80€</b>

## MOTORES ELEVADORES PARA SILLONES FEDESA®

Motores elevadores para sillones Fedesa®

RUMAR

	Descripción	Observaciones
	Motor subida Fedesa® <b>SH80 IP40</b>  <b>Ref.: FED-430A33</b>	 <b>528'00€*</b> ▶ <b>*Sin descuento</b>

# VARIOS REPUESTOS PARA SILLONES FEDESA®

Varios repuestos para sillones Fedesa®

RUMAR

NUEVO



Imagen no disponible

## Descripción

Manguera pedal movimientos eléctricos para sillones Fedesa®

Ref.: **FED-4103J11** (Ref. Fedesa®: 4103J11)



128'00€\*

## Observaciones

Compatible con todos los modelos de pedal Faro®  
**Incluye:** Pines para conector M/H JST, tubos neumáticos (5 de 1,5 mm y 2 de 4 mm), 11 cables de señal y una toma de tierra.

▶ **\*Sin descuento**

NUEVO



Imagen no disponible

Kit carrete de giro / Rodillos respaldo sillones Fedesa®

Ref.: **FED-1201E03** (Ref. Fedesa®: 1201E03)



48'00€\*

Pack 6 Uds.

▶ **\*Sin descuento**



Apoya instrumentos bandeja Midway-2

Ref.: **FED-038A06** (Ref. Fedesa®: 038A06)

29'80€



Brazo colibrí / pértiga Fedesa®

Ref.: **FED-520A51** (Ref. Fedesa®: 520A51)

18'00€

También montado en referencias: 4031B, 4027B, 4028B y 4029B)



Filtro sólido taza cestilla Fedesa®

Ref.: **FED-520A14** (Ref. Fedesa®: 520A14)

8'80€



Cubre filtro sólido cestilla Fedesa®

Ref.: **FED-4002Z05** (Ref. Fedesa®: 4002Z05)

7'80€

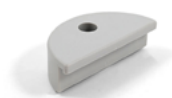

Portabandeja ranurado Fedesa®

Ref.: **FED-4014E05** (Ref. Fedesa®: 4014E05)

8'00€

NUEVO



Imagen no disponible

Cierre impacto oculto para sillones Fedesa®

Ref.: **FED-760A02** (Ref. Fedesa®: 760A02)



48'00€\*

▶ **\*Sin descuento**

NUEVO



Imagen no disponible

Colector filtro cánulas para sillones Fedesa®

Ref.: **FED-2403A06** (Ref. Fedesa®: 2403A06)



28'00€\*

▶ **\*Sin descuento**

**OTROS REPUESTOS FEDESA ¡CONSÚLTANOS!**

SI NO ENCUENTRAS EL REPUESTO QUE BUSCAS, ¡CONSÚLTANOS!  
Precios: impuestos, portes y mano de obra no incluidos.









	Descripción	Observaciones
NUEVO	 Imagen no disponible Kit escupidera 1 para sillones Fedesa® <b>Ref.: FED-ESCUPIADERA1</b> (Ref. Fedesa®: 2332C03 + 710A16 + 710A10 + 2332C04 + 2x710A11 + 710A37)	 <b>94<sup>80</sup>€*</b> ▶*Sin descuento <b>BAJO PEDIDO</b>
NUEVO	 Imagen no disponible Kit escupidera 2 para sillones Fedesa® <b>Ref.: FED-ESCUPIADERA2</b> (Ref. Fedesa®: 2332C03 + 710A16 + 710A10 + 2332C04 + 710A11 + 2332C13 + 710A37)	 <b>94<sup>80</sup>€*</b> ▶*Sin descuento <b>BAJO PEDIDO</b>
NUEVO	 Imagen no disponible Lavabo redondo ø30 cm para sillones Fedesa® <b>Ref.: FED-0250A11</b> (Ref. Fedesa®: 0250A11)	 <b>109<sup>80</sup>€*</b> ▶*Sin descuento <b>BAJO PEDIDO</b>
NUEVO	 Imagen no disponible Lavabo redondo ø30 cm para sillones Fedesa® <b>Ref.: FED-0250A01</b> (Ref. Fedesa®: 0250A01)	 <b>109<sup>80</sup>€*</b> ▶*Sin descuento <b>BAJO PEDIDO</b>

**OTROS REPUESTOS FEDESA ¡CONSÚLTANOS!**

# PISTONES PARA SILLONES FEDESA®

Pistones para sillones Fedesa®

RUMAR

	Descripción	Observaciones
	Pistón para sillones Fedesa®, <b>350 N</b>  <b>Ref.: FED-500A06</b>	<b>48<sup>80</sup>€</b>
	Pistón para sillones Fedesa®, <b>1500 N</b>  <b>Ref.: FED-500A21</b> (Ref. Fedesa®: 500A21)	<b>145<sup>80</sup>€</b>
	Pistón para sillones Fedesa®, <b>2700 N</b>  <b>Ref.: FED-500A24</b> (Ref. Fedesa®: 500A24)	<b>80<sup>80</sup>€</b>
	Pistón para sillones Fedesa®, <b>2100 N</b>  <b>Ref.: FED-500A40</b> (Ref. Fedesa®: 500A40)	<b>68<sup>00</sup>€</b>
	Pistón para sillones Fedesa®, <b>2500 N</b>  <b>Ref.: FED-500A41</b> (Ref. Fedesa®: 500A41)	<b>60<sup>80</sup>€</b>
	Pieza palanca pistones sillones Fedesa®  <b>Ref.: FED-0001</b>	<b>6<sup>80</sup>€</b>
	Cabeza disparo pistones para sillones Fedesa®  <b>Ref.: FED-0002</b>	<b>9<sup>80</sup>€</b>  <small>Diámetro rosca: 10mm</small>
	Cabeza disparo pistones para sillones Fedesa®  <b>Ref.: FED-0003</b>	<b>6<sup>80</sup>€</b>  <small>Diámetro rosca: 8mm</small>

PSD

## ▶ **PISTONES** PARA **SILLONES DENTALES**

- Pistones para sillones Fedesa®
- Pistones para sillones Sirona®

**PRÓXIMAMENTE NUEVAS REFERENCIAS ¡CONSÚLTANOS!**

## PISTONES PARA SILLONES FEDESA®

Pistones para sillones Fedesa®

RUMAR

Para pistones para sillones Fedesa®  
Ver sección Fedesa®: Pistones para sillones Fedesa®

## PISTONES PARA SILLONES SIRONA®

Pistones para sillones Sirona®

RUMAR

	Descripción	Observaciones
	<p>Pistón brazo lámpara Sirona® Sirolux, <b>460 N</b></p> <p>Ref: <b>SIR-5856757</b> (Ref. Sirona®: 5856757)</p>	<p><b>98<sup>00</sup>€</b></p>

RLE

## ▶ REPUESTOS LÁMPARAS EQUIPOS

- Bombillas sillones dentales
- Repuestos lámpara Faro® **Alya**
- Repuestos lámpara Faro® **Maia**
- Repuestos lámpara Faro® **EDI**
- Repuestos lámpara Faro® **Forma** y otras











# BOMBILLAS SILLONES DENTALES

Bombillas sillones dentales

RUMAR

**Descripción**

**Características**







	<p>Bombilla 17V 95W lámpara <b>EDI // Castellini® Venus</b></p> <p><b>Ref.: 80-021122</b> (Ref. Faro®: SP401122)</p>	<p><b>14'80€</b></p>
	<p>Bombilla OSRAM 12V 100W Lámpara Sirona®   Siemens® Sirolux-E y compatibles</p> <p><b>Ref.: 80-012018</b></p>	<p><b>14'80€</b></p>
	<p>Bombilla OSRAM 24V 150W Lámpara Sirona®   Siemens® Sirolux-F y compatibles</p> <p><b>Ref.: 80-006727</b></p>	<p><b>12'80€</b></p>
	<p>Bombilla OSRAM 24V 150W casquillo cerámico y otras Faro®</p> <p><b>Ref.: 80-64643FDS</b> (Ref. Faro®: SP406022)</p>	<p><b>22'80€</b></p>
	<p>Bombilla OSRAM 12V 75W (Filamento vertical) Lámpara Castellini® Luna y compatibles</p> <p><b>Ref.: 80-094291</b></p>	<p><b>12'80€</b></p>
	<p>Bombilla 24V 100W</p> <p><b>Ref.: 80-344961</b></p>	<p><b>12'80€</b></p>
	<p>Bombilla 24V 150W Lámparas KaVo® y compatibles</p> <p><b>Ref.: 80-392198</b></p>	<p><b>52'80€</b></p>

OTRAS REFERENCIAS DISPONIBLES CONSÚLTANOS

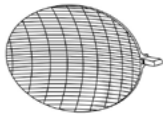
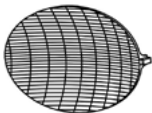
# REPUESTOS LÁMPARAS ALYA

Repuestos Lámparas Faro® Alya, Alya-TheiaTech, Alya CAM



	Descripción	Características
	<p>Palanca interruptor lámpara <b>Alya</b></p> <p><b>Ref.: 80-010108</b> (Ref. Faro®: SP310108)</p> <p><b>20<sup>80</sup>€</b></p>	
	<p>Pareja reflectores lámpara <b>Alya</b> <b>(N/S&lt;10LD012150)</b></p> <p><b>Ref.: 80-010025</b> (Ref. Faro®: SP310025)</p> <p><b>99<sup>80</sup>€</b></p>	
	<p>Pareja reflectores lámpara <b>Alya</b> <b>(N/S&gt;10LD012150)</b></p> <p><b>Ref.: 80-010025006</b> (Ref. Faro®: SP310025006)</p> <p><b>99<sup>80</sup>€</b></p>	
	<p>Kit soportes y asas blancas (derecha + izquierda) lámpara <b>Alya (Todas)</b></p> <p><b>Ref.: 80-010390006</b> (Ref. Faro®: SP310390006= SP310352006+SP310370006)</p> <p><b>182<sup>80</sup>€</b></p>	
	<p>Kit soportes asas blancas (derecha + izquierda) lámpara <b>Alya</b> <b>(N/S&gt;11LD005228)</b></p> <p><b>Ref.: 80-010352006</b> (Ref. Faro®: SP310352006)</p> <p><b>47<sup>80</sup>€</b></p>	
	<p>Kit asas blancas (derecha + izquierda) lámpara <b>Alya</b> <b>(N/S&gt;11LD005228)</b></p> <p><b>Ref.: 80-010370006</b> (Ref. Faro®: SP310370006)</p> <p><b>139<sup>80</sup>€</b></p>	
	<p>Interruptor completo lámpara <b>Alya</b></p> <p><b>Ref.: 80-010102</b> (Ref. Faro®: SP310102)</p> <p><b>80<sup>00</sup>€</b></p>	
 <p>80-010285 80-010125B</p>	<p>Kit Grupo LED + Placa electrónica <u>con interruptor</u> y carcasa blanca para lámpara <b>Alya</b></p> <p><b>Ref.: 80-010700</b> (Ref. Faro®: SP510700 = SP510285 + SP510125)</p> <p><b>598<sup>00</sup>€</b></p>	<p>N/S&lt;10LD012150 <b>NO</b> válido N/S&gt;10LD012151 Válido</p>
 <p>80-010285 80-010130B</p>	<p>Kit Grupo LED + Placa electrónica <u>con sensor</u> y carcasa blanca para lámpara <b>Alya</b></p> <p><b>Ref.: 80-010701</b> (Ref. Faro®: SP510701 = SP510285 + SP510130)</p> <p><b>598<sup>00</sup>€</b></p>	<p>N/S&lt;10LD012150 <b>NO</b> válido N/S&gt;10LD012151 Válido</p>

BAJO PEDIDO

OTRAS REFERENCIAS DISPONIBLES CONSÚLTANOS

SI NO ENCUENTRAS EL REPUESTO QUE BUSCAS, ¡CONSÚLTANOS!  
Precios: impuestos, portes y mano de obra no incluidos.

	Descripción	Características
	<p>Grupo LED lámpara <b>Alya</b> (15LD005044&lt;N/S&lt;17LD010112)</p> <p><b>Ref.: 80-010435</b> (Ref. Faro®: SP310435)</p>	<p>Recomendamos upgrade con Kit <b>80-010700</b> (con interruptor) o <b>80-010701</b> (con sensor).</p> <p><b>438<sup>00</sup>€</b></p>
	<p>Placa electrónica con sensor y carcasa gris lámpara <b>Alya</b> (N/S&lt;10LD012150)</p> <p><b>Ref.: 80-010130</b> (Ref. Faro®: SP310130)</p>	<p><b>418<sup>80</sup>€</b></p> <p><b>BAJO PEDIDO</b></p>
	<p>Placa electrónica con interruptor y carcasa blanca lámpara <b>Alya</b> (15LD5044 &lt; N/S &lt; 17LD010112)</p> <p><b>Ref.: 80-010480006</b> (Ref. Faro®: SP310480006)</p>	<p>Recomendamos upgrade con <b>80-010700</b> (con interruptor).</p> <p><b>312<sup>80</sup>€</b></p>
	<p>Placa electrónica con sensor y carcasa "blanca" lámpara <b>Alya</b> (15LD005044&lt;N/S&lt;17LD010112)</p> <p><b>Ref.: 80-010485006</b> (Ref. Faro®: SP310485006)</p>	<p>Recomendamos upgrade con <b>80-010701</b> (con sensor).</p> <p><b>428<sup>00</sup>€</b></p>

**OTRAS REFERENCIAS DISPONIBLES CONSÚLTANOS**

# REPUESTOS LÁMPARAS MAIA

Repuestos Lámparas Faro® Maia

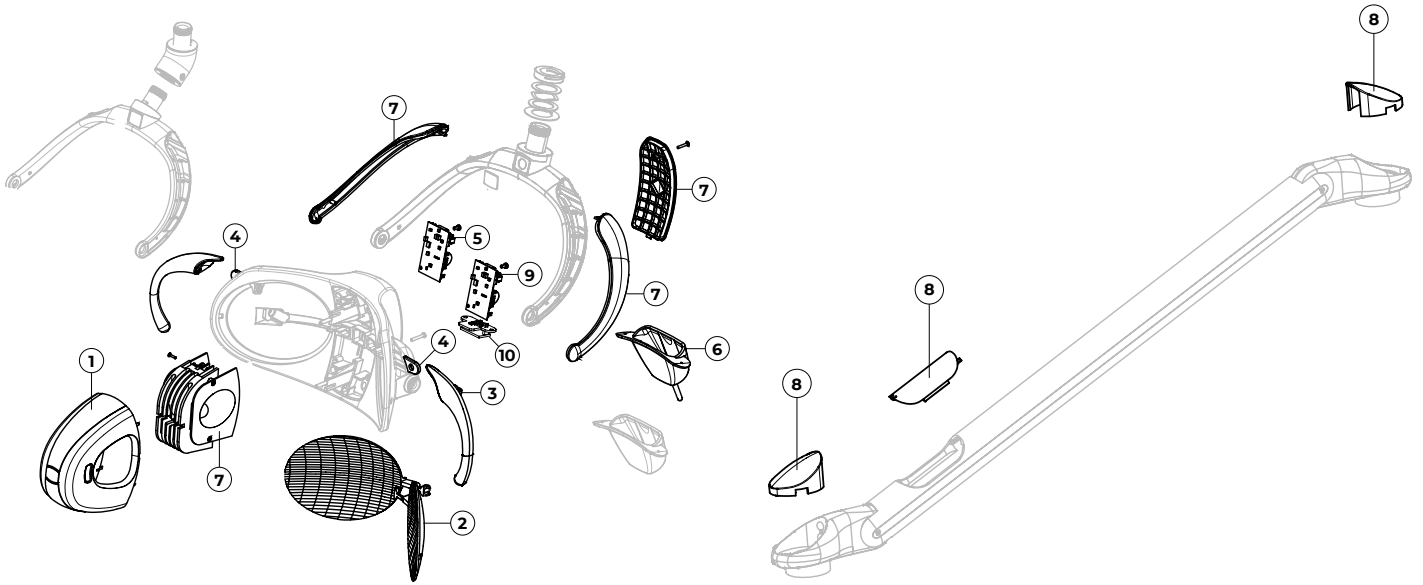

## Descripción

Kit reparación Faro lámpara MAIA con interruptor (N/S>15LD011296)

### Incluye:

- |               |   |
|---------------|---|
| 1. SP320901   | Carcasa grupo LED   |
| 2. 80-030902  | Pareja de reflectores (Ref. Faro: SP320902)                   |
| 3. 80-026365  | Kit asas (derecha + izquierda) (Ref. Faro: SP320904)          |
| 4. 80-030905  | Kit soportes (derecha + izquierda) (Ref. Faro: SP320905)      |
| 5. 80-030906A | Placa electrónica (N/S>15LD011296) (Ref. Faro: SP320906A)     |
| 6. 80-030907A | Interruptor c/palanca (N/S>15LD011296) (Ref. Faro: SP320907A) |
| 7. 80-030911  | Kit carcadas cabeza (Ref. Faro: SP320911)                     |
| 8. SP320912   | Kit cubiertas brazo   |
| 9. SP320926   | A Placa electrónica Maia*sensor (N/S>15LD011296)              |
| 10. SP320927  | Sensor Maia   |
| 80-030095     | Cable de grupo LED a placa electrónica (Ref. Faro SP310095)   |
| SP310104      | Buzzer  |
| SP320085      | Cable PCB a fuente de alimentación                            |
| SP310139      | Cable PCB a lámpara set                                       |

Ref.: 80-030900

808<sup>00</sup>€

## Características



Palanca interruptor lámpara **Maia**

Ref.: 80-030908 (Ref. Faro®: SP320908/5)

4<sup>10</sup>€

1 Unidad











Interruptor con palanca lámpara **Maia**  
(N/S>15LD011296)

Ref.: 80-030907 (Ref. Faro®: SP320907)

101<sup>80</sup>€

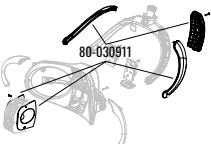
OTRAS REFERENCIAS DISPONIBLES CONSÚLTANOS

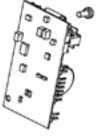
SI NO ENCUENTRAS EL REPUESTO QUE BUSCAS, ¡CONSÚLTANOS!  
Precios: impuestos, portes y mano de obra no incluidos.









	Descripción	Características
	<p>Interruptor con palanca lámpara <b>Maia</b> (N/S&gt;15LD011296)</p> <p><b>Ref.: 80-030907A</b> (Ref. Faro®: SP320907A)</p> <p><b>101<sup>80</sup>€</b></p>	
	<p>Pareja reflectores lámpara <b>Maia</b></p> <p><b>Ref.: 80-030902</b> (Ref. Faro®: SP320902)</p> <p><b>90<sup>80</sup>€</b></p>	
	<p>Kit asas (derecha + izquierda) lámpara <b>EDI y Maia</b></p> <p><b>Ref.: 80-026365</b> (Ref. Faro®: SP306365; SP320904)</p> <p><b>101<sup>80</sup>€</b></p>	
	<p>Kit soportes (derecha + izquierda) lámpara <b>Maia</b></p> <p><b>Ref.: 80-030905</b> (Ref. Faro®: SP320905)</p> <p><b>9<sup>80</sup>€</b></p>	Pack 1 pareja
	<p>Kit carcasa cabeza lámpara <b>Maia</b></p> <p><b>Ref.: 80-030911</b></p> <p><b>76<sup>80</sup>€</b></p>	
	<p>Cable de grupo LED a placa electrónica lámparas <b>Maia y Alya</b></p> <p><b>Ref.: 80-030095</b> (Ref. Faro®: 310095)</p> <p><b>33<sup>80</sup>€</b></p>	
	<p>Grupo LED lámpara <b>Maia</b></p> <p><b>Ref.: 80-030903</b> (Ref. Faro®: SP320903)</p> <p><b>333<sup>80</sup>€</b></p>	
	<p>Placa electrónica lámpara <b>Maia</b> (N/S&lt;15LD011296)</p> <p><b>Ref.: 80-030906</b> (Ref. Faro®: SP320906)</p> <p><b>269<sup>80</sup>€</b></p>	
	<p>Placa electrónica lámpara <b>Maia</b> (N/S&gt;15LD011296)</p> <p><b>Ref.: 80-030906A</b> (Ref. Faro SP320906A)</p> <p><b>321<sup>80</sup>€</b></p>	

**OTRAS REFERENCIAS DISPONIBLES CONSÚLTANOS**

# REPUESTOS LÁMPARAS EDI

## Repuestos Lámparas Faro® Edi



	Descripción	Características
	Interruptor bipolar lámpara <b>EDI</b>  <b>Ref.: 80-029005</b> (Ref. Faro®: SP409005)	29 <sup>80</sup> €
	Reflector lámpara <b>EDI</b>  <b>Ref.: 80-026001</b> (Ref. Faro®: 306001)	1 Unidad  144 <sup>80</sup> €
	Protección frontal lámpara <b>EDI</b>  <b>Ref.: 80-026029</b> (Ref. Faro®: 306029)	67 <sup>80</sup> €
	Protector bombilla lámpara <b>EDI</b>  <b>Ref.: 80-026027</b> (Ref. Faro®: 306027)	23 <sup>80</sup> €
	Kit soportes (derecha + izquierda) lámpara <b>EDI</b>  <b>Ref.: 80-026364</b> (Ref. Faro®: SP306364=SP306035+SP306038)	46 <sup>80</sup> €
	Kit asas (derecha + izquierda) lámpara <b>EDI</b> y <b>Maia</b>  <b>Ref.: 80-026365</b> (Ref. Faro®: SP306365; SP320904)	101 <sup>80</sup> €
	Protector térmico lámpara <b>EDI</b>  <b>Ref.: 80-026032</b> (Ref. Faro®: SP306032)	14 <sup>80</sup> €
	Regulador intensidad lámpara <b>EDI</b>  <b>Ref.: 80-026053</b> (Ref. Faro®: SP306053)	35 <sup>80</sup> €
	Asa inferior lámpara <b>EDI</b>  <b>Ref.: 80-026076</b> (Ref. Faro®: SP306076)	35 <sup>80</sup> €

OTRAS REFERENCIAS DISPONIBLES CONSÚLTANOS

SI NO ENCUENTRAS EL REPUESTO QUE BUSCAS, ¡CONSÚLTANOS!  
 Precios: impuestos, portes y mano de obra no incluidos.







	Descripción	Características
	<p>Ventilador lámpara <b>EDI</b></p> <p>Ref.: <b>80-026079</b> (Ref. Faro®: SP306079)</p> <p><b>60</b> <sup>80</sup>€</p>	
	<p>Electrónica ventilador lámpara <b>EDI</b></p> <p>Ref.: <b>80-026080</b> (Ref. Faro®: SP306080)</p> <p><b>39</b> <sup>80</sup>€</p>	
	<p>Porta lámparas lámpara <b>EDI</b></p> <p>Ref.: <b>80-026019</b> (Ref. Faro®: SP306019)</p> <p><b>21</b> <sup>80</sup>€</p>	
	<p>Bombilla 17V 95W lámpara <b>EDI // Castellini® Venus</b></p> <p>Ref.: <b>80-021122</b> (Ref. Faro®: SP401122)</p> <p><b>14</b> <sup>80</sup>€</p>	
	<p>Brazo trasero, 75 cm, lámpara <b>EDI</b> (RAL 9016*)</p> <p>Ref.: <b>80-026262</b></p> <p><b>456</b> <sup>80</sup>€</p>	<p>*Otro RAL consultar.</p>

**OTRAS REFERENCIAS DISPONIBLES CONSÚLTANOS**

# REPUESTOS LÁMPARAS FORMA

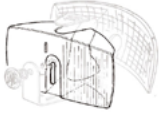
Repuestos Lámparas **Faro**® Forma, S90, SC y TS90



Descripción		Características
	Bombilla OSRAM 24V 150W casquillo cerámico y otras Faro®  <b>Ref.: 80-64643FDS</b> (Ref. Faro®: SP406022)	22 <sup>80</sup> €
	Interruptor unipolar con transformador lámparas <b>Forma</b>  <b>Ref.: 80-058116</b> (Ref. Faro®: SP408116)	18 <sup>80</sup> €
	Plexiglas protección frontal lámparas <b>Forma 2000</b>  <b>Ref.: 80-058858</b> (Ref. Faro®: SP408858)	58 <sup>80</sup> €
	Regulador intensidad lámparas <b>Forma 2000/90</b>  <b>Ref.: 80-058877</b> (Ref. Faro®: SP408877)	16 <sup>80</sup> €
	Electrónica con ventilador lámparas <b>Forma 2000/90</b>  <b>Ref.: 80-055284</b> (Ref. Faro®: SP305284)	126 <sup>80</sup> €
	Porta lámparas lámparas <b>Forma 2000/90</b>  <b>Ref.: 80-058005</b> (Ref. Faro®: SP408005)	44 <sup>80</sup> €

**OTRAS REFERENCIAS DISPONIBLES CONSÚLTANOS**

# RUMAR

RAS





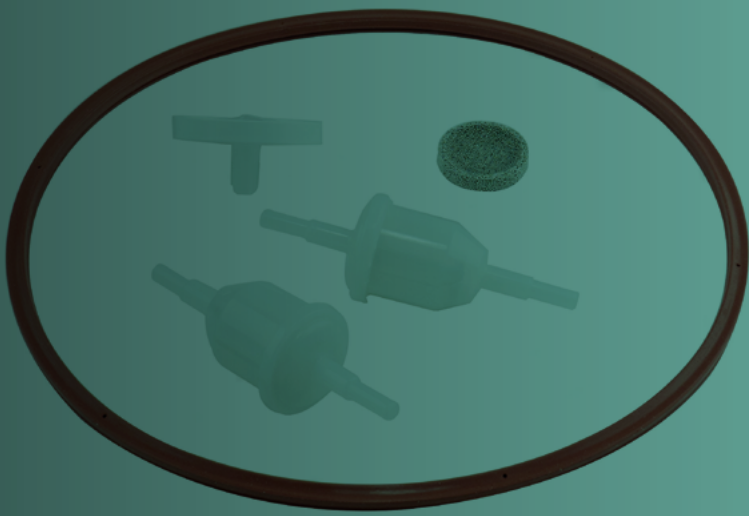
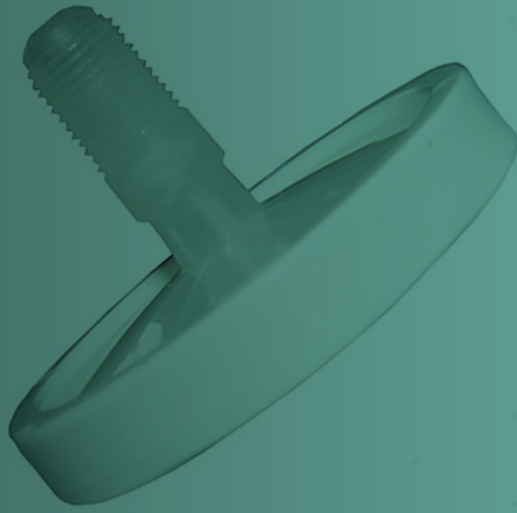

## ▶ REPUESTOS AUTOCLAVES Y SELLADORAS







## Repuestos Autoclaves / Repuestos Autoclaves FARO®



	Descripción	Características
	Kit mantenimiento autoclave Faro® SK07, Moon, Step y Easy-R  <b>Ref.: 80-302705</b> (Ref. Faro®: SP742705)	<b>Incluye:</b> 2x Filtros agua (Ref. Faro® 707175X2) Junta puerta (Ref. Faro® 708014) Filtro caldera (Ref. Faro® 737068) Tubos carga / descarga (Ref. Faro® 742589) Filtro bacteriológico (Ref. Faro® 742631)
	Junta puerta autoclave Faro® SK07, Moon, Step, Easy-R, Just  <b>Ref.: 80-308014</b> (Ref. Faro®: SP708014)	<b>49<sup>80</sup>€</b>
	Junta puerta autoclave Faro® Nisea  <b>Ref.: 80-300067</b> (Ref. Faro®: SP750067)	<b>25<sup>80</sup>€</b>
	Maneta autoclave Faro® SK07  <b>Ref.: 80-302526</b> (Ref. Faro® SP742526)	<b>80<sup>00</sup>€</b>
	Filtro agua autoclave Faro® SK07 (pack: 2 uds)  <b>Ref.: 80-307175</b> (Ref. Faro®: SP707175)	<b>22<sup>80</sup>€</b>
	Tubos de carga y descarga autoclaves Faro®  <b>Ref.: 80-302592</b> (Ref. Faro®: SP742592)	<b>38<sup>80</sup>€</b>
	Filtro bacteriológico autoclaves "todos los modelos"  <b>Ref.: 70-0004</b> (Ref. Faro®: 742631/3, 737079)	<b>18<sup>80</sup>€</b>

OTRAS REFERENCIAS DISPONIBLES CONSÚLTANOS

Filtros bacteriológicos autoclaves

Conexión Abierta / Open End		Descripción
	<p>Filtro bacteriológico autoclave <b>"ROSCA LARGA"</b>                      Utilizado en autoclaves: Cominox®, Mocom®, Tecnogaz®, W&amp;H® (algunos modelos), Satelec® Acteon®, NSK® (algunos modelos)</p> <p><b>Ref.: 70-0004</b></p>	<p>Medidas conexión:                      1/8" x 25mm</p> <p><b>18<sup>80</sup>€</b></p>
	<p>Filtro bacteriológico autoclave <b>"ROSCA CORTA"</b>                      Utilizado en autoclaves: Euronda®, Icanclave®, W&amp;H® (algunos modelos), NSK® (algunos modelos)</p> <p><b>Ref.: 70-0008</b></p>	<p>Medidas conexión:                      1/8" x 18mm</p> <p><b>18<sup>80</sup>€</b></p>

Repuestos Selladoras: Repuestos Selladoras FARO®



Descripción	Características
<p>Cuchilla selladora Sella II <b>(con soporte)</b></p> <p><b>Ref.: 80-700301</b> (Ref. Faro®: SP700301)</p>	<p><b>55<sup>80</sup>€</b></p>
<p>Resistencia selladora Sella II <b>(con junta)</b></p> <p><b>Ref.: 80-700303</b> (Ref. Faro®: 700303)</p>	<p><b>110<sup>80</sup>€</b></p>
<p>Cuchilla selladora SL13 <b>(sin soporte)</b></p> <p><b>Ref.: 80-700353</b> (Ref. Faro®: SP700353)</p>	<p><b>68<sup>80</sup>€</b></p>

OTRAS REFERENCIAS DISPONIBLES CONSÚLTANOS

SI NO ENCUENTRAS EL REPUESTO QUE BUSCAS, ¡CONSÚLTANOS!  
 Precios: impuestos, portes y mano de obra no incluidos.

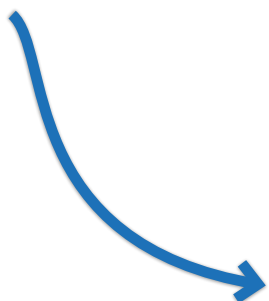

RBV

## ▶ REPUESTOS BOMBAS DE VACÍO

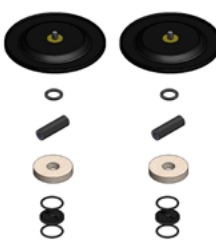

**Consúltanos**  
por el que necesitas para tu  
**autoclave**

Kits de mantenimiento

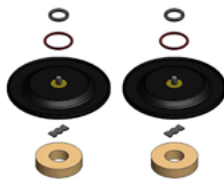
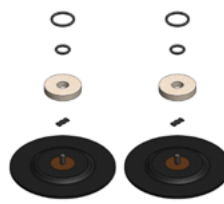
	Descripción	Observaciones
	<p>Kit de mantenimiento de <b>H5</b> y <b>H5P3</b></p> <p><b>Suministro incluye:</b></p> <ul style="list-style-type: none"> <li>- <b>Membrana:</b> H5, EPDM 02 con tornillo (1ud.)</li> <li>- <b>Anillos tóricos:</b> 16,5x1,5mm, silicona roja (4uds.)</li> <li>- <b>Obturador:</b> H5, FPM (2Uds.)</li> </ul> <p><b>Ref.: 08-H5001</b></p>	<p><b>70<sup>80</sup>€</b></p>
	<p>Kit completo de mantenimiento <b>EVO10</b></p> <p><b>Suministro incluye:</b></p> <ul style="list-style-type: none"> <li>- <b>Membrana:</b> EVO10, EPDM 02, con tornillo (2 uds.)</li> <li>- <b>Anillos tóricos:</b> 9,50x2,00mm, EPDM (4 uds.)</li> <li>- <b>Grupo válvula obturador:</b> EVO sin anilla (6 uds.)*</li> <li>- <b>Tubo:</b> EPDM EVO (1 ud.)</li> <li>- <b>Filtro silenciador:</b> EVO10 (2 uds.)</li> </ul> <p>* Este grupo válvula obturador equivale al "obturador EVO FPM + anillo tórico 17,10x1,60 EPDM" del otro kit, pero esta versión es más duradera y es la que recomienda el fabricante.</p> <p><b>Ref.: 08-EVO10001</b></p>	<p><b>299<sup>80</sup>€</b></p>
	<p>Kit completo de mantenimiento <b>EVO30</b></p> <p><b>Suministro incluye:</b></p> <ul style="list-style-type: none"> <li>- <b>Membrana:</b> EVO30, EPDM, con tornillo (2 uds.)</li> <li>- <b>Anillos tóricos:</b> 9,50x2,00mm, EPDM (4 uds.)</li> <li>- <b>Grupo válvula obturador:</b> EVO sin anilla (6 uds.)*</li> <li>- <b>Tubo:</b> EPDM EVO (1 ud.)</li> <li>- <b>Filtro silenciador:</b> EVO30 (2 uds.)</li> </ul> <p><b>Ref.: 08-EVO30001</b></p>	<p><b>324<sup>80</sup>€</b></p>
	<p>Kit de mantenimiento <b>HX10P3 05</b></p> <p><b>Suministro incluye:</b></p> <ul style="list-style-type: none"> <li>- <b>Membrana:</b> EVO10, EPDM, con tornillo (2 uds.)</li> <li>- <b>Anillos tóricos:</b> 9,50 x 2,00mm, EPDM (4 uds.)</li> <li>- <b>Anillos tóricos:</b> 16,50 x 1,50mm, silicona roja (4 uds.)</li> <li>- <b>Obturador:</b> H10, FPM (4 uds.)</li> <li>- <b>Filtro silenciador:</b> EVO10 (2 uds.)</li> </ul> <p><b>Ref.: 08-HX10P3001</b></p>	<p><b>180<sup>00</sup>€</b></p>
	<p>Kit de mantenimiento <b>HX30P3 05 Serie</b></p> <p><b>Suministro incluye:</b></p> <ul style="list-style-type: none"> <li>- <b>Membrana:</b> EVO30, EPDM, con tornillo (2 uds.)</li> <li>- <b>Anillos tóricos:</b> 17 x 2,00mm, EPDM (4 uds.)</li> <li>- <b>Anillos tóricos:</b> 9,50 x 2,00mm, EPDM (4 uds.)</li> <li>- <b>Obturador:</b> EVO, FPM (4 uds.)</li> <li>- <b>Filtro silenciador:</b> EVO30 (2 uds.)</li> </ul> <p><b>Ref.: 08-HX30P3001</b></p>	<p><b>244<sup>80</sup>€</b></p>

JRJ

## ▶ JERINGAS Y REPUESTOS JERINGAS

- Jeringas **Luzzani**® y sus repuestos
- Jeringas **FARO**® y sus repuestos
- Jeringas económicas
- Puntas compatibles jeringas



RUMAR

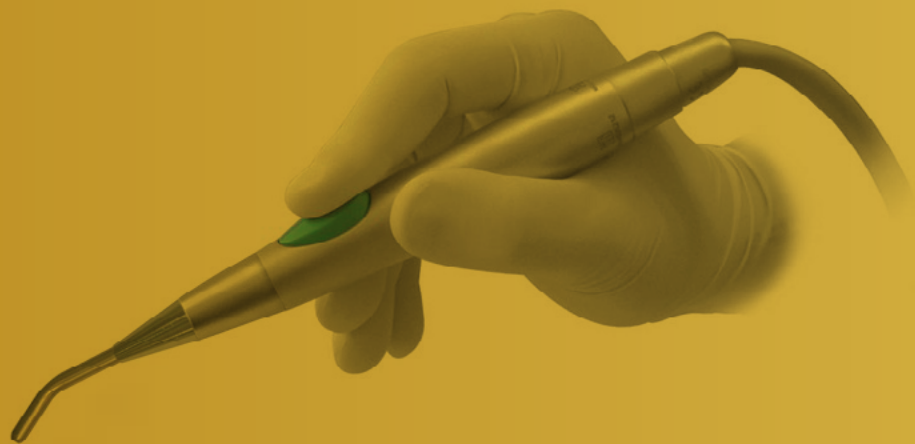
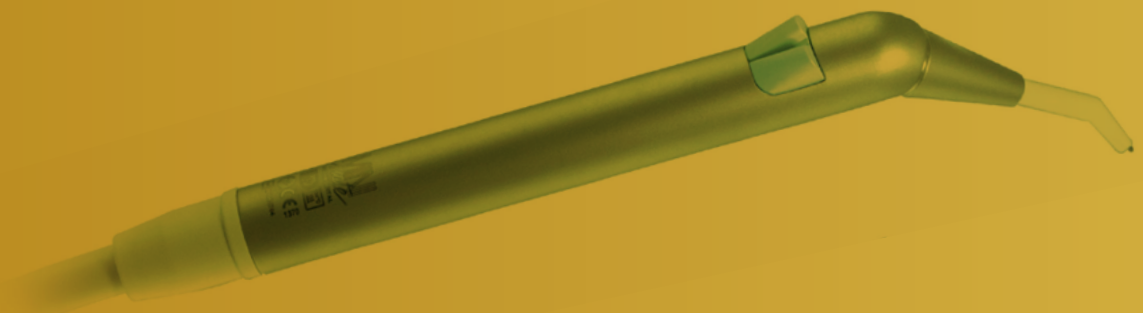
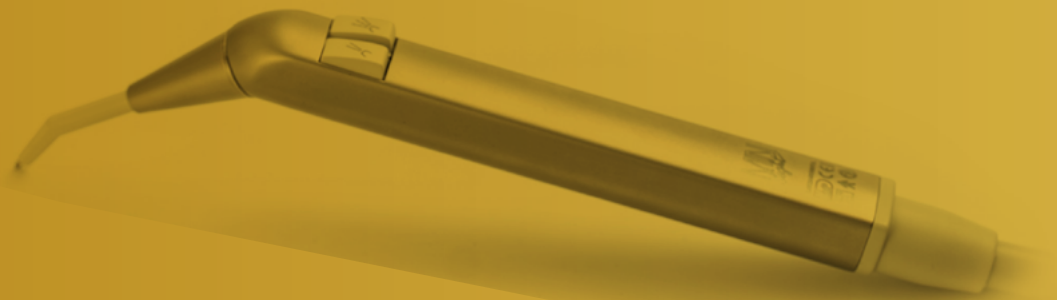
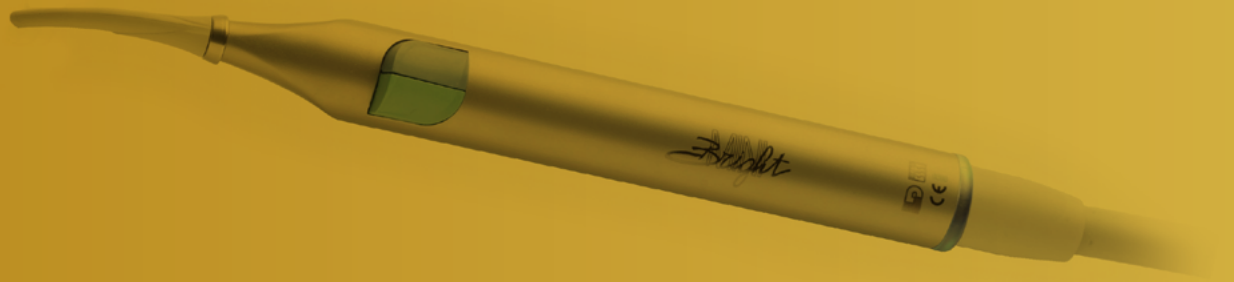



Consulta por las  
puntas desechables

**Pro-Tip TURBO**

## Jeringas Luzzani® Minibright



### Conexión Abierta / Open End

Jeringa Minibright 6F con luz  
Conexión equipo: Abierta

### Características

**Longitud:** 170cm  
**Forma:** Recta  
**Color:** Gris (RAL 7038)  
**Material:** Acero

Ref.: **39-3151**





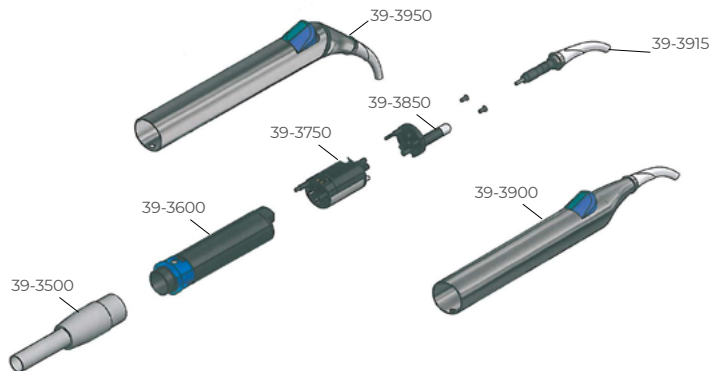

**498<sup>00</sup>€**

TODOS LOS REPUESTOS JERINGAS LUZZANI® CONSULTE PRECIOS Y DESPIECES

Consulta por las  
puntas desechables  
**Pro-Tip TURBO**

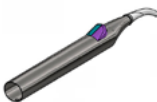

Repuestos Jeringas MinibrighT: F6 y EFFE 6 BEI

	Descripción	Características
	Punta jeringa MinibrighT  <b>Ref.: 39-3915</b>	<b>29<sup>80</sup>€</b>
	Kit completo reparación MinibrighT  <b>Ref.: 39-3000</b>	<b>55<sup>80</sup>€</b>
	Kit completo anillos tóricos MinibrighT  <b>Ref.: 39-3001</b>	<b>18<sup>80</sup>€</b>
	Cabeza completa MinibrighT  <b>Ref.: 39-3750</b>	<b>218<sup>80</sup>€</b>
	LED MinibrighT  <b>Ref.: 39-3850</b>	<b>73<sup>80</sup>€</b>
	Cuerpo central MinibrighT  <b>Ref.: 39-3600</b>	<b>161<sup>80</sup>€</b>
	Manguera completa MinibrighT  <b>Ref.: 39-3500</b>	Longitud: 170cm Color: Gris (RAL 7038)  <b>123<sup>80</sup>€</b>
	Carcasa completa MinibrighT  <b>Ref.: 39-3900</b>	<b>175<sup>80</sup>€</b>

TODOS LOS REPUESTOS JERINGAS LUZZANI® CONSULTE PRECIOS Y DESPIECES





SI NO ENCUENTRAS EL REPUESTO QUE BUSCAS, ¡CONSÚLTANOS!  
Precios: impuestos, portes y mano de obra no incluidos.

Consulta por las  
puntas desechables  
**Pro-Tip TURBO**



Jeringas Luzzani® Minilight: **Conexión Abierta / Open End**



Conexión Abierta / Open End		Características
	Jeringa Minilight 3F. <b>Conexión equipo:</b> Abierta  <b>Ref.: 39-12521</b>	<b>Longitud:</b> 170cm <b>Forma:</b> Recta <b>Color:</b> Gris (RAL 7038) <b>Material:</b> Acero  <b>275'80€</b>
	Jeringa Minilight 3F. <b>Conexión equipo:</b> Abierta  <b>Ref.: 39-12621</b>	<b>Longitud:</b> 170cm <b>Forma:</b> Angulada <b>Color:</b> Gris (RAL 7038) <b>Material:</b> Acero  <b>289'80€</b>
	Jeringa Minilight 6F. <b>Conexión equipo:</b> Abierta  <b>Ref.: 39-11521</b>	<b>Longitud:</b> 170cm <b>Forma:</b> Recta <b>Color:</b> Gris (RAL 7038) <b>Material:</b> Acero  <b>389'80€</b>
	Jeringa Minilight 6F. <b>Conexión equipo:</b> Abierta  <b>Ref.: 39-11621</b>	<b>Longitud:</b> 170cm <b>Forma:</b> Angulada <b>Color:</b> Gris (RAL 7038) <b>Material:</b> Acero  <b>405'80€</b>

Jeringas Luzzani® Minilight: **Conector a equipo Cefla® (Desde 2006)**













Conector a equipo Cefla® (desde 2006)		Descripción
 	Jeringa Minilight 3F <b>Conexión equipo Cefla® (desde 2006):</b> Anthos®: A3, A5, A6, A7, A9, L6, L9, R7; Stern Weber®: S200, S220TR S250, S280TRC, S300, 320TR, S320TR, S380TRC; Castellini®: SKEMA 5, SKEMA 6, SKEMA 8  <b>Ref.: 39-12521C1</b>	<b>Longitud:</b> 120cm <b>Forma:</b> Recta <b>Color:</b> Gris (RAL 7038) <b>Material:</b> Acero  <b>396'80€</b>
 	Jeringa Minilight 3F <b>Conexión equipo Cefla® (desde 2006):</b> Anthos®: A3, A5, A6, A7, A9, L6, L9, R7; Stern Weber®: S200, S220TR S250, S280TRC, S300, 320TR, S320TR, S380TRC; Castellini®: SKEMA 5, SKEMA 6, SKEMA 8  <b>Ref.: 39-12521C2</b>	<b>Longitud:</b> 135cm <b>Forma:</b> Recta <b>Color:</b> Gris (RAL 7038) <b>Material:</b> Acero  <b>396'80€</b>
 	Jeringa Minilight 3F <b>Conexión equipo Cefla® (desde 2006):</b> Anthos®: A3, A5, A6, A7, A9, L6, L9, R7; Stern Weber®: S200, S220TR S250, S280TRC, S300, 320TR, S320TR, S380TRC; Castellini®: SKEMA 5, SKEMA 6, SKEMA 8  <b>Ref.: 39-12621C1</b>	<b>Longitud:</b> 120cm <b>Forma:</b> Angulada <b>Color:</b> Gris (RAL 7038) <b>Material:</b> Acero  <b>418'00€</b>

TODOS LOS REPUESTOS JERINGAS LUZZANI® CONSULTE PRECIOS Y DESPIECES

## Conector a equipo Cefla® (desde 2006)

## Descripción









		<p>Jeringa Minilight 3F</p> <p><b>Conexión equipo Cefla® (desde 2006):</b>  <b>Anthos®:</b> A3, A5, A6, A7, A9, L6, L9, R7; <b>Stern Weber®:</b> S200, S220TR S250, S280TRC, S300, 320TR, S320TR, S380TRC;  <b>Castellini®:</b> SKEMA 5, SKEMA 6, SKEMA 8</p>	<p><b>Longitud:</b> 135cm  <b>Forma:</b> Angulada  <b>Color:</b> Gris (RAL 7038)  <b>Material:</b> Acero</p>	
		<b>Ref.: 39-12621C2</b>	<b>418<sup>00</sup>€</b>	
		<p>Jeringa Minilight 6F</p> <p><b>Conexión equipo Cefla® (desde 2006):</b>  <b>Anthos®:</b> A3, A5, A6, A7, A9, L6, L9, R7; <b>Stern Weber®:</b> S200, S220TR S250, S280TRC, S300, 320TR, S320TR, S380TRC;  <b>Castellini®:</b> SKEMA 5, SKEMA 6, SKEMA 8</p>	<p><b>Longitud:</b> 120cm  <b>Forma:</b> Recta  <b>Color:</b> Gris (RAL 7038)  <b>Material:</b> Acero</p>	
		<b>Ref.: 39-11521C1</b>	<b>539<sup>00</sup>€</b>	<b>BAJO PEDIDO</b>
		<p>Jeringa Minilight 6F</p> <p><b>Conexión equipo Cefla® (desde 2006):</b>  <b>Anthos®:</b> A3, A5, A6, A7, A9, L6, L9, R7; <b>Stern Weber®:</b> S200, S220TR S250, S280TRC, S300, 320TR, S320TR, S380TRC;  <b>Castellini®:</b> SKEMA 5, SKEMA 6, SKEMA 8</p>	<p><b>Longitud:</b> 135cm  <b>Forma:</b> Recta  <b>Color:</b> Gris (RAL 7038)  <b>Material:</b> Acero</p>	
		<b>Ref.: 39-11521C2</b>	<b>539<sup>00</sup>€</b>	<b>BAJO PEDIDO</b>
		<p>Jeringa Minilight 6F</p> <p><b>Conexión equipo Cefla® (desde 2006):</b>  <b>Anthos®:</b> A3, A5, A6, A7, A9, L6, L9, R7; <b>Stern Weber®:</b> S200, S220TR S250, S280TRC, S300, 320TR, S320TR, S380TRC;  <b>Castellini®:</b> SKEMA 5, SKEMA 6, SKEMA 8</p>	<p><b>Longitud:</b> 120cm  <b>Forma:</b> Angulada  <b>Color:</b> Gris (RAL 7038)  <b>Material:</b> Acero</p>	
		<b>Ref.: 39-11621C1</b>	<b>564<sup>80</sup>€</b>	<b>BAJO PEDIDO</b>
		<p>Jeringa Minilight 6F</p> <p><b>Conexión equipo Cefla® (desde 2006):</b>  <b>Anthos®:</b> A3, A5, A6, A7, A9, L6, L9, R7; <b>Stern Weber®:</b> S200, S220TR S250, S280TRC, S300, 320TR, S320TR, S380TRC;  <b>Castellini®:</b> SKEMA 5, SKEMA 6, SKEMA 8</p>	<p><b>Longitud:</b> 135cm  <b>Forma:</b> Angulada  <b>Color:</b> Gris (RAL 7038)  <b>Material:</b> Acero</p>	
		<b>Ref.: 39-11621C2</b>	<b>564<sup>80</sup>€</b>	<b>BAJO PEDIDO</b>

## Jeringas Luzzani® Minilight: Conector a equipo KaVo®



## Conector a equipo KaVo®

## Descripción





















		<p>Jeringa Minilight 3F</p> <p><b>Conexión equipo:</b> KaVo® 1057, 1058, 1060, 1062, 1063, 1065, 1066, 1078, 1080 (Series 1) <b>**Excepto**</b> 1058 Primus Life</p>	<p><b>Longitud:</b> 120cm  <b>Forma:</b> Recta  <b>Color:</b> Gris (RAL 7038)  <b>Material:</b> Acero</p>
		<b>Ref.: 39-12521K1</b>	<b>396<sup>80</sup>€</b>
		<p>Jeringa Minilight 3F</p> <p><b>Conexión equipo:</b> KaVo® 1057, 1058, 1060, 1062, 1063, 1065, 1066, 1078, 1080 (Series 1) <b>**Excepto**</b> 1058 Primus Life</p>	<p><b>Longitud:</b> 135cm  <b>Forma:</b> Recta  <b>Color:</b> Gris (RAL 7038)  <b>Material:</b> Acero</p>
		<b>Ref.: 39-12521K2</b>	<b>396<sup>80</sup>€</b>
		<p>Jeringa Minilight 3F</p> <p><b>Conexión equipo:</b> KaVo® E30, E50, E70, E80 y 1058 Primus Life (Serie 2)</p>	<p><b>Longitud:</b> 120cm  <b>Forma:</b> Recta  <b>Color:</b> Gris (RAL 7038)  <b>Material:</b> Acero</p>
		<b>Ref.: 39-12521K3</b>	<b>398<sup>00</sup>€</b>
		<p>Jeringa Minilight 3F</p> <p><b>Conexión equipo:</b> KaVo® E30, E50, E70, E80 y 1058 Primus Life (Serie 2)</p>	<p><b>Longitud:</b> 135cm  <b>Forma:</b> Recta  <b>Color:</b> Gris (RAL 7038)  <b>Material:</b> Acero</p>
		<b>Ref.: 39-12521K4</b>	<b>398<sup>00</sup>€</b>

TODOS LOS REPUESTOS JERINGAS LUZZANI® CONSULTE PRECIOS Y DESPIECES

SI NO ENCUENTRAS EL REPUESTO QUE BUSCAS, ¡CONSÚLTANOS!  
 Precios: impuestos, portes y mano de obra no incluidos.

## Conector a equipo KaVo®









## Características

		Jeringa Minilight 3F <b>Conexión equipo:</b> KaVo® 1057, 1058, 1060, 1062, 1063, 1065, 1066, 1078, 1080 (Series 1) <b>**Excepto**</b> 1058 Primus Life	<b>Longitud:</b> 120cm <b>Forma:</b> Angulada <b>Color:</b> Gris (RAL 7038) <b>Material:</b> Acero	
<b>Ref.:</b> 39-12621K1			<b>418<sup>00</sup>€</b>	
		Jeringa Minilight 3F <b>Conexión equipo:</b> KaVo® 1057, 1058, 1060, 1062, 1063, 1065, 1066, 1078, 1080 (Series 1) <b>**Excepto**</b> 1058 Primus Life	<b>Longitud:</b> 135cm <b>Forma:</b> Angulada <b>Color:</b> Gris (RAL 7038) <b>Material:</b> Acero	
<b>Ref.:</b> 39-12621K2			<b>418<sup>00</sup>€</b>	
		Jeringa Minilight 6F <b>Conexión equipo:</b> KaVo® 1057, 1058, 1060, 1062, 1063, 1065, 1066, 1078, 1080 (Series 1) <b>**Excepto**</b> 1058 Primus Life	<b>Longitud:</b> 120cm <b>Forma:</b> Recta <b>Color:</b> Gris (RAL 7038) <b>Material:</b> Acero	
<b>Ref.:</b> 39-11521K1			<b>564<sup>80</sup>€</b>	<b>BAJO PEDIDO</b>
		Jeringa Minilight 6F <b>Conexión equipo:</b> KaVo® 1057, 1058, 1060, 1062, 1063, 1065, 1066, 1078, 1080 (Series 1) <b>**Excepto**</b> 1058 Primus Life	<b>Longitud:</b> 135cm <b>Forma:</b> Recta <b>Color:</b> Gris (RAL 7038) <b>Material:</b> Acero	
<b>Ref.:</b> 39-11521K2			<b>564<sup>80</sup>€</b>	<b>BAJO PEDIDO</b>
		Jeringa Minilight 6F <b>Conexión equipo:</b> KaVo® 1057, 1058, 1060, 1062, 1063, 1065, 1066, 1078, 1080 (Series 1) <b>**Excepto**</b> 1058 Primus Life	<b>Longitud:</b> 120cm <b>Forma:</b> Angulada <b>Color:</b> Gris (RAL 7038) <b>Material:</b> Acero	
<b>Ref.:</b> 39-11621K1			<b>564<sup>80</sup>€</b>	<b>BAJO PEDIDO</b>
		Jeringa Minilight 6F <b>Conexión equipo:</b> KaVo® 1057, 1058, 1060, 1062, 1063, 1065, 1066, 1078, 1080 (Series 1) <b>**Excepto**</b> 1058 Primus Life	<b>Longitud:</b> 135cm <b>Forma:</b> Angulada <b>Color:</b> Gris (RAL 7038) <b>Material:</b> Acero	
<b>Ref.:</b> 39-11621K2			<b>564<sup>80</sup>€</b>	<b>BAJO PEDIDO</b>
		Jeringa Minilight 6F <b>Conexión equipo:</b> KaVo®, E30, E50, E70, E80, 1058 Primus Life (Serie 2)	<b>Longitud:</b> 120cm <b>Forma:</b> Recta <b>Color:</b> Gris (RAL 7038) <b>Material:</b> Acero	
<b>Ref.:</b> 39-11521K3			<b>554<sup>80</sup>€</b>	<b>BAJO PEDIDO</b>
		Jeringa Minilight 6F <b>Conexión equipo:</b> KaVo®, E30, E50, E70, E80, 1058 Primus Life (Serie 2)	<b>Longitud:</b> 135cm <b>Forma:</b> Recta <b>Color:</b> Gris (RAL 7038) <b>Material:</b> Acero	
<b>Ref.:</b> 39-11521K4			<b>554<sup>80</sup>€</b>	<b>BAJO PEDIDO</b>
		Jeringa Minilight 6F <b>Conexión equipo:</b> KaVo®, E30, E50, E70, E80, 1058 Primus Life (Serie 2)	<b>Longitud:</b> 120cm <b>Forma:</b> Angulada <b>Color:</b> Gris (RAL 7038) <b>Material:</b> Acero	
<b>Ref.:</b> 39-11621K3			<b>575<sup>80</sup>€</b>	<b>BAJO PEDIDO</b>
		Jeringa Minilight 6F <b>Conexión equipo:</b> KaVo®, E30, E50, E70, E80, 1058 Primus Life (Serie 2)	<b>Longitud:</b> 135cm <b>Forma:</b> Angulada <b>Color:</b> Gris (RAL 7038) <b>Material:</b> Acero	
<b>Ref.:</b> 39-11621K4			<b>575<sup>80</sup>€</b>	<b>BAJO PEDIDO</b>

TODOS LOS REPUESTOS JERINGAS LUZZANI® CONSULTE PRECIOS Y DESPIECES

Jeringas Luzzani® Minilight: **Conector a equipo Planmeca®**



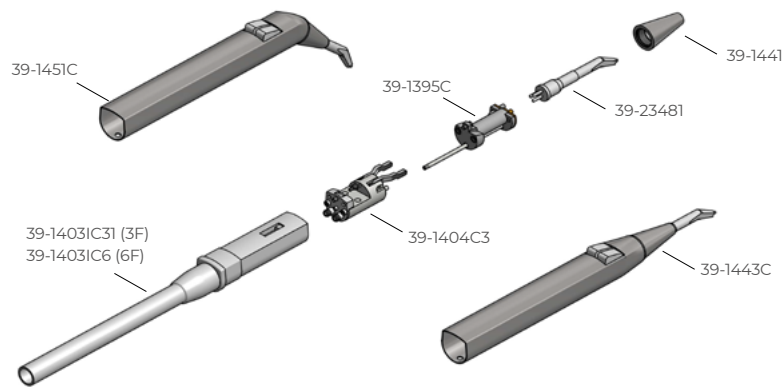

Conector a equipo Planmeca®		Características
  <p>Jeringa Minilight 3F Conexión equipo: Planmeca®</p> <p><b>Ref.: 39-12521P1</b></p>	<p><b>418<sup>00</sup>€</b></p>	<p>Longitud: 100cm Forma: Recta Color: Gris claro (RAL 9002) Material: Acero Resistencia: 1.780 Ohm</p>
  <p>Jeringa Minilight 3F Conexión equipo: Planmeca®</p> <p><b>Ref.: 39-12621P1</b></p>	<p><b>428<sup>00</sup>€</b></p>	<p>Longitud: 100cm Forma: Angulada Color: Gris claro (RAL 9002) Material: Acero Resistencia: 1.780 Ohm</p> <p><b>BAJO PEDIDO</b></p>
  <p>Jeringa Minilight 6F Conexión equipo: Planmeca®</p> <p><b>Ref.: 39-11521P1</b> (Ref. Planmeca®: 52600287-20)</p>	<p><b>508<sup>00</sup>€</b></p>	<p>Longitud: 100cm Forma: Recta Color: Gris claro (RAL9002) Material: Acero Resistencia: 1.780 Ohm</p> <p><b>BAJO PEDIDO</b></p>
  <p>Jeringa Minilight 6F Conexión equipo: Planmeca®</p> <p><b>Ref.: 39-11621P1</b></p>	<p><b>508<sup>00</sup>€</b></p>	<p>Longitud: 100cm Forma: Angulada Color: Gris real (RAL 9002) Material: Acero Resistencia: 1.780 Ohm</p> <p><b>BAJO PEDIDO</b></p>



Consulta por las puntas desechables **Pro-Tip TURBO**









Repuestos Jeringas Minilight

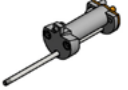

Descripción	Características
 <p>Kit completo reparación</p> <p><b>Ref.: 39-1000</b></p>	<p><b>35<sup>80</sup>€</b></p>
 <p>Kit completo 18 anillos tóricos</p> <p><b>Ref.: 39-1001</b></p>	<p><b>21<sup>80</sup>€</b></p>

TODOS LOS REPUESTOS JERINGAS LUZZANI® CONSULTE PRECIOS Y DESPIECES

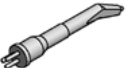
SI NO ENCUENTRAS EL REPUESTO QUE BUSCAS, ¡CONSÚLTANOS!  
Precios: impuestos, portes y mano de obra no incluidos.



	Descripción	Características
	Cabeza completa 3F  <b>Ref.: 39-1395C</b>	<b>78<sup>80</sup>€</b>
	Manguera completa jeringa 3F  <b>Ref.: 39-14031C31</b>	<b>75<sup>80</sup>€</b> Longitud: 170cm Color: Gris (RAL 7038) Material jeringa: Acero
	Manguera completa jeringa 6F  <b>Ref.: 39-14031C6</b>	<b>143<sup>80</sup>€</b> Longitud: 170cm Color: Gris (RAL 7038) Material jeringa: Acero
	Cuerpo jeringa 3F (NO 6F)  <b>Ref.: 39-1404C3</b>	<b>128<sup>80</sup>€</b>
	Cuerpo jeringa 6F  <b>Ref.: 39-1404</b>	<b>128<sup>80</sup>€</b>
	Cono Acero  <b>Ref.: 39-1441</b>	<b>15<sup>80</sup>€</b>
	Carcasa completa recta Acero  <b>Ref.: 39-1443C</b>	<b>131<sup>80</sup>€</b>
	Carcasa completa angulada Acero  <b>Ref.: 39-1451C</b>	<b>156<sup>80</sup>€</b>
	Punta gris  <b>Ref.: 39-23481</b>	<b>20<sup>80</sup>€</b>
	Adaptador jeringas Minilight Tecnopolimero a Acero  <b>Ref.: 39-1400</b>	<b>6<sup>80</sup>€</b>

TODOS LOS REPUESTOS JERINGAS LUZZANI® CONSULTE PRECIOS Y DESPIECES

Consulta por las  
puntas desechables  
**Pro-Tip TURBO**



**Jeringas Luzzani® Minimate: Conexión Abierta / Open End**

Conexión Abierta / Open End		Características
	Jeringa Minimate 3F <b>Conexión equipo:</b> Abierta  <b>Ref.: 39-251</b>	<b>Longitud:</b> 170cm <b>Forma:</b> Recta <b>Color:</b> Gris (RAL 7038) <b>Material:</b> Acero  <b>226<sup>80</sup>€</b>
	Jeringa Minimate 3F <b>Conexión equipo:</b> Abierta  <b>Ref.: 39-261</b>	<b>Longitud:</b> 170cm <b>Forma:</b> Angulada <b>Color:</b> Gris (RAL 7038) <b>Material:</b> Acero  <b>236<sup>80</sup>€</b>

**Jeringas Luzzani® Minimate: Conector a equipo Cefla® (desde 2006)**



Conector a equipo Cefla® desde 2006		Descripción
 	Jeringa Minimate 3F <b>Conexión equipo Cefla® (desde 2006):</b> Anthos®: A3, A5, A6, A7, A9, L6, L9, R7; Stern Weber®: S200, S220TR S250, S280TRC, S300, 320TR, S320TR, S380TRC; Castellini®: SKEMA 5, SKEMA 6, SKEMA 8  <b>Ref.: 39-251C1</b>	<b>Longitud:</b> 120cm <b>Forma:</b> Recta <b>Color:</b> Gris (RAL 7038) <b>Material:</b> Acero  <b>328<sup>00</sup>€</b>
 	Jeringa Minimate 3F <b>Conexión equipo Cefla® (desde 2006):</b> Anthos®: A3, A5, A6, A7, A9, L6, L9, R7; Stern Weber®: S200, S220TR S250, S280TRC, S300, 320TR, S320TR, S380TRC; Castellini®: SKEMA 5, SKEMA 6, SKEMA 8  <b>Ref.: 39-251C2</b>	<b>Longitud:</b> 135cm <b>Forma:</b> Recta <b>Color:</b> Gris (RAL 7038) <b>Material:</b> Acero  <b>328<sup>00</sup>€</b>
 	Jeringa Minimate 3F <b>Conexión equipo Cefla® (desde 2006):</b> Anthos®: A3, A5, A6, A7, A9, L6, L9, R7; Stern Weber®: S200, S220TR S250, S280TRC, S300, 320TR, S320TR, S380TRC; Castellini®: SKEMA 5, SKEMA 6, SKEMA 8  <b>Ref.: 39-261C1</b>	<b>Longitud:</b> 120cm <b>Forma:</b> Angulada <b>Color:</b> Gris (RAL 7038) <b>Material:</b> Acero  <b>348<sup>00</sup>€</b>
 	Jeringa Minimate 3F <b>Conexión equipo Cefla® (desde 2006):</b> Anthos®: A3, A5, A6, A7, A9, L6, L9, R7; Stern Weber®: S200, S220TR S250, S280TRC, S300, 320TR, S320TR, S380TRC; Castellini®: SKEMA 5, SKEMA 6, SKEMA 8  <b>Ref.: 39-261C2</b>	<b>Longitud:</b> 135cm <b>Forma:</b> Angulada <b>Color:</b> Gris (RAL 7038) <b>Material:</b> Acero  <b>348<sup>00</sup>€</b>















TODOS LOS REPUESTOS JERINGAS LUZZANI® CONSULTE PRECIOS Y DESPIECES

SI NO ENCUENTRAS EL REPUESTO QUE BUSCAS, ¡CONSÚLTANOS!  
Precios: impuestos, portes y mano de obra no incluidos.

## Jeringas Luzzani® Minimate: Conector a equipo KaVo®

### Conexión a equipo KaVo®





### Características

		<p>Jeringa Minimate 3F  <b>Conexión equipo:</b> KaVo® 1057, 1058, 1060, 1062, 1063, 1065, 1066, 1078, 1080 (Series 1) <b>**Excepto**</b> 1058 Primus Life</p>	<p><b>Longitud:</b> 120cm  <b>Forma:</b> Recta  <b>Color:</b> Gris (RAL 7038)  <b>Material:</b> Acero</p>
<b>Ref.:</b>	<b>39-251K1</b>	<b>328´00€</b>	
		<p>Jeringa Minimate 3F  <b>Conexión equipo:</b> KaVo® 1057, 1058, 1060, 1062, 1063, 1065, 1066, 1078, 1080 (Series 1) <b>**Excepto**</b> 1058 Primus Life</p>	<p><b>Longitud:</b> 135cm  <b>Forma:</b> Recta  <b>Color:</b> Gris (RAL 7038)  <b>Material:</b> Acero</p>
<b>Ref.:</b>	<b>39-251K2</b>	<b>328´00€</b>	
		<p>Jeringa Minimate 3F  <b>Conexión equipo:</b> KaVo®, E30, E50, E70, E80, 1058 Primus Life (Serie 2)</p>	<p><b>Longitud:</b> 120cm  <b>Forma:</b> Recta  <b>Color:</b> Gris (RAL 7038)  <b>Material:</b> Acero</p>
<b>Ref.:</b>	<b>39-251K3</b>	<b>338´00€</b>	
		<p>Jeringa Minimate 3F  <b>Conexión equipo:</b> KaVo®, E30, E50, E70, E80, 1058 Primus Life (Serie 2)</p>	<p><b>Longitud:</b> 135cm  <b>Forma:</b> Recta  <b>Color:</b> Gris (RAL 7038)  <b>Material:</b> Acero</p>
<b>Ref.:</b>	<b>39-251K4</b>	<b>338´00€</b>	<b>BAJO PEDIDO</b>
		<p>Jeringa Minimate 3F  <b>Conexión equipo:</b> KaVo® 1057, 1058, 1060, 1062, 1063, 1065, 1066, 1078, 1080 (Series 1) <b>**Excepto**</b> 1058 Primus Life</p>	<p><b>Longitud:</b> 120cm  <b>Forma:</b> Angulada  <b>Color:</b> Gris (RAL 7038)  <b>Material:</b> Acero</p>
<b>Ref.:</b>	<b>39-261K1</b>	<b>348´00€</b>	
		<p>Jeringa Minimate 3F  <b>Conexión equipo:</b> KaVo® 1057, 1058, 1060, 1062, 1063, 1065, 1066, 1078, 1080 (Series 1) <b>**Excepto**</b> 1058 Primus Life</p>	<p><b>Longitud:</b> 135cm  <b>Forma:</b> Angulada  <b>Color:</b> Gris (RAL 7038)  <b>Material:</b> Acero</p>
<b>Ref.:</b>	<b>39-261K2</b>	<b>344´80€</b>	
		<p>Jeringa Minimate 3F  <b>Conexión equipo:</b> KaVo®, E30, E50, E70, E80, 1058 Primus Life (Serie 2)</p>	<p><b>Longitud:</b> 120cm  <b>Forma:</b> Angulada  <b>Color:</b> Gris (RAL 7038)  <b>Material:</b> Acero</p>
<b>Ref.:</b>	<b>39-261K3</b>	<b>354´80€</b>	

## Jeringas Luzzani® Minimate: Conector a equipo Planmeca®

### Conexión a equipo Planmeca®

### Descripción

		<p>Jeringa Minimate 3F  <b>Conexión equipo:</b> Planmeca®</p>	<p><b>Longitud:</b> 100cm  <b>Forma:</b> Recta  <b>Color:</b> Gris real (RAL 9002)  <b>Material:</b> Acero  <b>Resistencia:</b> 1.780 Ohm</p>
<b>Ref.:</b>	<b>39-251P1</b>	<b>358´80€</b>	
		<p>Jeringa Minimate 3F  <b>Conexión equipo:</b> Planmeca®</p>	<p><b>Longitud:</b> 100cm  <b>Forma:</b> Angulada  <b>Color:</b> Gris real (RAL 9002)  <b>Material:</b> Acero  <b>Resistencia:</b> 1.780 Ohm</p>
<b>Ref.:</b>	<b>39-261P1</b>	<b>368´80€</b>	<b>BAJO PEDIDO</b>

TODOS LOS REPUESTOS JERINGAS LUZZANI® CONSULTE PRECIOS Y DESPIECES

Consulta por las  
puntas desechables  
**Pro-Tip<sup>TURBO</sup>**



Repuestos Jeringas Minimate



	Descripción	Características
	Kit completo reparación  <b>Ref.: 39-2000</b>	<b>36'80€</b>
	Manguera completa para jeringa 3F  <b>Ref.: 39-22011</b>	Longitud: 170cm Color: Gris (RAL 7038) Material jeringa: Acero  <b>79'80€</b>
	Cuerpo jeringa 3F  <b>Ref.: 39-2202C</b>	<b>104'80€</b>
	Cono Acero  Origen: Italia      Fabricante: Luzzani® Dental S.R.L.      Garantía: 12 meses  <b>Ref.: 39-2223</b>	<b>15'80€</b>
	Carcasa completa recta Acero  <b>Ref.: 39-2243C</b>	Forma: Recta Material: Acero  <b>118'00€</b>
	Carcasa completa angulada Acero  <b>Ref.: 39-2251C</b>	Forma: Angulada Material: Acero  <b>129'80€</b>
	Punta gris  <b>Ref.: 39-23481</b>	<b>20'80€</b>

TODOS LOS REPUESTOS JERINGAS LUZZANI® CONSULTE PRECIOS Y DESPIECES

SI NO ENCUENTRAS EL REPUESTO QUE BUSCAS, ¡CONSÚLTANOS!  
Precios: impuestos, portes y mano de obra no incluidos.

Consulta por las  
puntas desechables  
**Pro-Tip<sup>®</sup>TURBO**

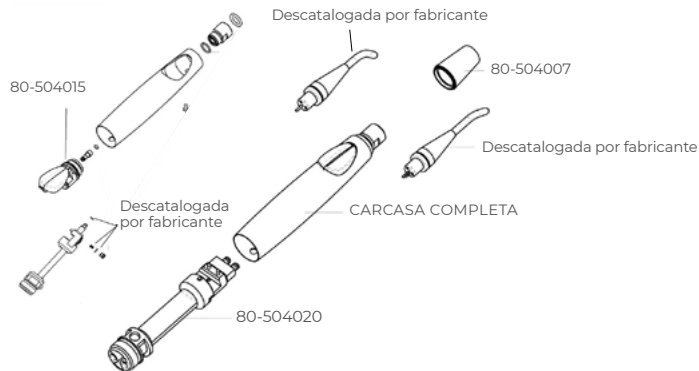

Repuestos Jeringas Faro<sup>®</sup> SYR3



Descripción	Características
 <p>Cono acero</p> <p><b>Ref.: 80-504007</b> (Ref. Faro<sup>®</sup>: SP094007)</p>	<p><b>27<sup>80</sup>€</b></p> <p>HASTA AGOTAR</p>
 <p>Botonera aire/agua jeringa (luds)</p> <p><b>Ref.: 80-504015</b> (Ref. Faro<sup>®</sup>: SP094015 /3)</p>	<p><b>24<sup>80</sup>€</b></p> <p>HASTA AGOTAR</p>



Repuestos Jeringas Faro<sup>®</sup> SM3



Descripción	Características
 <p>Medios aire/agua</p> <p><b>Ref.: 80-501291</b> (Ref. Faro<sup>®</sup>: SP091291)</p>	<p><b>29<sup>80</sup>€</b></p> <p>HASTA AGOTAR</p>

Jeringas de acero ECO



Descripción	Características
 <p>Jeringa de acero, 3F angulada (No manguera)*</p> <p><b>Ref.: 44-280</b></p>	<p><b>32<sup>80</sup>€</b></p> <p>*Ver manguera 40-61A2000</p>
 <p>Jeringa de acero, 3F recta (No manguera)*</p> <p><b>Ref.: 44-281</b></p>	<p><b>32<sup>80</sup>€</b></p> <p>*Ver manguera 40-61A2000</p>
 <p>Cánulas de repuesto, esterilizables</p> <p><b>Ref.: 44-285</b></p>	<p><b>2<sup>80</sup>€</b></p>

TODOS LOS REPUESTOS FARO<sup>®</sup> CONSULTE PRECIOS Y DESPIECES

## Puntas compatibles jeringas

RUMAR

	Descripción	Características
	Punta para jeringa <b>Cefla® 3F</b> . Compatible  <b>Ref.: 44-287</b> (Ref. Cefla®: 95520612)	Esterilizable 135°C  <b>58<sup>00</sup>€</b>
	Punta para jeringa <b>KaVo® 3F</b> . Compatible  <b>Ref.: 44-288</b> (Ref. KaVo®: 0.773.0011)	Esterilizable 135°C  <b>108<sup>00</sup>€</b>
	Punta para jeringa <b>Sirona® 3F</b> . Compatible  <b>Ref.: 44-289</b> (Ref. Sirona®: 5992206)	Esterilizable 135°C  <b>108<sup>00</sup>€</b>

TODOS LOS REPUESTOS FARO® CONSULTE PRECIOS Y DESPIECES

SI NO ENCUENTRAS EL REPUESTO QUE BUSCAS, ¡CONSÚLTANOS!  
 Precios: impuestos, portes y mano de obra no incluidos.

RUMAR 161

## ▶ MANGUERAS EQUIPO

- Mangueras turbinas con y sin conector a equipo
- Mangueras ultrasonidos con y sin conector a equipo
- Mangueras micromotores con y sin conector a equipo
- Accesorios mangueras
- Mangueras jeringas con y sin conector a equipo
- Mangueras pedales

RUMAR



- **Origen:** Italia
- **Fabricante:** Tekne Dental (TKD®)
- **Silicona de máxima calidad** que garantiza su durabilidad y el mantenimiento de los colores durante más tiempo.
- **Cables y tubos internos de la más alta calidad para una mayor durabilidad**
- **Valvulería de acero** para las mangueras con regulación de spray: mayor precisión y durabilidad.

**12 MESES DE GARANTÍA**

**¡Los fabricantes de sillones, y nosotros, confiamos en ellos!**

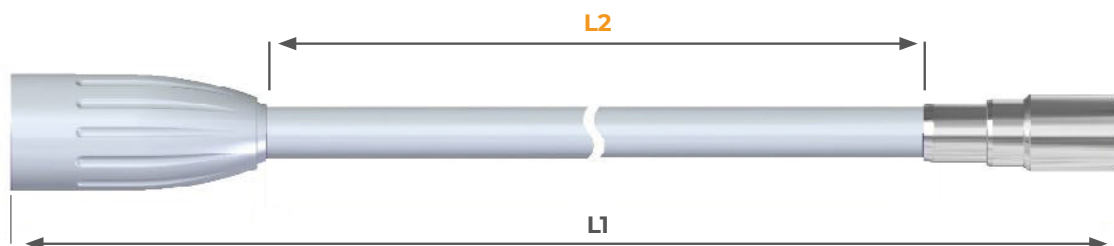

**L2:** Longitud indicada en cada referencia en este catálogo.

### Información sobre tonos de Gris:

Gris CLARO= **RAL 9002** (Tipo: KaVo®, Planmeca® y similares)

Gris = **RAL 7035** (Tipo: ADEC y similares)

Gris OSCURO = **RAL 7038** (Tipo: Fedesa y similares) o RAL 7035+ (EEUU)



# MANGUERAS TURBINAS

Conexión a equipo: **Abierta / Open end** > Cefla® > KaVo® > Planmeca® > Sirona®

## Mangueras Turbina: Conexión Abierta / Open End











RUMAR



### Mangueras Turbina: Conexión Abierta / Open End

### Características

	<p><b>Conexión instrumento:</b> Borden 3 - 3 orificios, sin luz <b>Conexión equipo:</b> Abierta</p> <p><b>Origen:</b> Italia      <b>Fabricante:</b> Tekne Dental (TKD®)      <b>Garantía:</b> 12 meses</p> <p><b>Ref.:</b> <b>40-31A2001</b></p>	<p><b>Longitud:</b> 160cm - Rizada <b>Color:</b> Gris oscuro (Ral 7038)</p>
	<p><b>Conexión instrumento:</b> Borden 3 - 3 orificios, sin luz <b>Conexión equipo:</b> Abierta</p> <p><b>Origen:</b> Italia      <b>Fabricante:</b> Tekne Dental (TKD®)      <b>Garantía:</b> 12 meses</p> <p><b>Ref.:</b> <b>40-31A2000</b></p>	<p><b>Longitud:</b> 160cm <b>Color:</b> Gris oscuro (RAL 7038)</p>
	<p><b>Conexión instrumento:</b> Midwest 4 con luz - 6 orificios <b>Conexión equipo:</b> Abierta</p> <p><b>Origen:</b> Italia      <b>Fabricante:</b> Tekne Dental (TKD®)      <b>Garantía:</b> 12 meses</p> <p><b>Ref.:</b> <b>40-11B1000</b></p>	<p><b>Longitud:</b> 200cm <b>Color:</b> Gris claro (RAL 9002)</p>
	<p><b>Conexión instrumento:</b> Midwest 4 con luz - 6 orificios, <b>Conexión equipo:</b> Abierta</p> <p><b>Origen:</b> Italia      <b>Fabricante:</b> Tekne Dental (TKD®)      <b>Garantía:</b> 12 meses</p> <p><b>Ref.:</b> <b>40-11A1000</b></p>	<p><b>Longitud:</b> 160cm <b>Color:</b> Gris claro (RAL 9002)</p>
	<p><b>Conexión instrumento:</b> Midwest 4 con luz - 6 orificios <b>Conexión equipo:</b> Abierta</p> <p><b>Origen:</b> Italia      <b>Fabricante:</b> Tekne Dental (TKD®)      <b>Garantía:</b> 12 meses</p> <p><b>Ref.:</b> <b>40-11A1001</b></p>	<p><b>Longitud:</b> 160cm <b>Color:</b> Gris claro (RAL 9002) <b>Regulación de spray</b></p>
	<p><b>Conexión instrumento:</b> Midwest 4 con luz - 6 orificios <b>Conexión equipo:</b> Abierta</p> <p><b>Origen:</b> Italia      <b>Fabricante:</b> Tekne Dental (TKD®)      <b>Garantía:</b> 12 meses</p> <p><b>Ref.:</b> <b>40-11B2000</b></p>	<p><b>Longitud:</b> 200cm <b>Color:</b> Gris oscuro (RAL 7038)</p>
	<p><b>Conexión instrumento:</b> Midwest 4 con luz - 6 orificios <b>Conexión equipo:</b> Abierta</p> <p><b>Origen:</b> Italia      <b>Fabricante:</b> Tekne Dental (TKD®)      <b>Garantía:</b> 12 meses</p> <p><b>Ref.:</b> <b>40-11A2000</b></p>	<p><b>Longitud:</b> 160cm <b>Color:</b> Gris oscuro (RAL 7038)</p>
	<p><b>Conexión instrumento:</b> Midwest 4 con luz - 6 orificios <b>Conexión equipo:</b> Abierta</p> <p><b>Origen:</b> Italia      <b>Fabricante:</b> Tekne Dental (TKD®)      <b>Garantía:</b> 12 meses</p> <p><b>Ref.:</b> <b>40-11A2001</b></p>	<p><b>Longitud:</b> 160cm <b>Color:</b> Gris oscuro (RAL 7038) <b>Regulación de spray</b></p>
	<p><b>Conexión instrumento:</b> Midwest 4 con luz - 6 orificios <b>Conexión equipo:</b> Abierta</p> <p><b>Origen:</b> Italia      <b>Fabricante:</b> Tekne Dental (TKD®)      <b>Garantía:</b> 12 meses</p> <p><b>Ref.:</b> <b>40-11A2002</b></p>	<p><b>Longitud:</b> 160cm <b>Color:</b> Gris oscuro (RAL 7038) <b>Diámetro:</b> 10,33mm <b>(Especial equipos Vitali, OMS y comp.)</b></p>

	Mangueras Turbina: Conexión Abierta / Open End	Descripción
	<p><b>Conexión instrumento:</b> Midwest 4 con luz – 6 orificios <b>Conexión equipo:</b> Abierta</p> <p><b>Origen:</b> Italia      <b>Fabricante:</b> Tekne Dental (TKD®)      <b>Garantía:</b> 12 meses</p> <p><b>Ref.:</b> <b>40-11B3000</b></p>	<p><b>Longitud:</b> 200cm <b>Color:</b> Negro</p> <p><b>75'80€</b></p>
	<p><b>Conexión instrumento:</b> Midwest 4 con luz – 6 orificios <b>Conexión equipo:</b> Abierta</p> <p><b>Origen:</b> Italia      <b>Fabricante:</b> Tekne Dental (TKD®)      <b>Garantía:</b> 12 meses</p> <p><b>Ref.:</b> <b>40-11B4000</b></p>	<p><b>Longitud:</b> 200cm <b>Color:</b> Blanco</p> <p><b>75'80€</b></p>
	<p><b>Conexión instrumento:</b> Midwest 4 sin luz – 4 orificios <b>Conexión equipo:</b> Abierta</p> <p><b>Origen:</b> Italia      <b>Fabricante:</b> Tekne Dental (TKD®)      <b>Garantía:</b> 12 meses</p> <p><b>Ref.:</b> <b>40-21A2001</b></p>	<p><b>Longitud:</b> 160cm - <b>Rizada</b> <b>Color:</b> Gris oscuro (RAL 7038)</p> <p><b>39'80€</b></p>
	<p><b>Conexión instrumento:</b> Midwest 4 sin luz – 4 orificios <b>Conexión equipo:</b> Abierta</p> <p><b>Origen:</b> Italia      <b>Fabricante:</b> Tekne Dental (TKD®)      <b>Garantía:</b> 12 meses</p> <p><b>Ref.:</b> <b>40-21A1000</b></p>	<p><b>Longitud:</b> 160cm <b>Color:</b> Gris claro (RAL 9002)</p> <p><b>54'80€</b></p>
	<p><b>Conexión instrumento:</b> Midwest 4 sin luz – 4 orificios <b>Conexión equipo:</b> Abierta</p> <p><b>Origen:</b> Italia      <b>Fabricante:</b> Tekne Dental (TKD®)      <b>Garantía:</b> 12 meses</p> <p><b>Ref.:</b> <b>40-21A2000</b></p>	<p><b>Longitud:</b> 160cm <b>Color:</b> Gris oscuro (RAL 7038)</p> <p><b>54'80€</b></p>
	<p><b>Conexión instrumento:</b> Midwest 4 sin luz – 4 orificios <b>Conexión equipo:</b> Abierta</p> <p><b>Origen:</b> Italia      <b>Fabricante:</b> Tekne Dental (TKD®)      <b>Garantía:</b> 12 meses</p> <p><b>Ref.:</b> <b>40-21A2002</b></p>	<p><b>Longitud:</b> 160cm <b>Color:</b> Gris oscuro (RAL 7038) <b>Regulación de spray</b></p> <p><b>148'00€</b></p>
	<p><b>Conexión instrumento:</b> Midwest 4 sin luz – 4 orificios <b>Conexión equipo:</b> Abierta</p> <p><b>Origen:</b> Italia      <b>Fabricante:</b> Tekne Dental (TKD®)      <b>Garantía:</b> 12 meses</p> <p><b>Ref.:</b> <b>40-21B1000</b></p>	<p><b>Longitud:</b> 200cm <b>Color:</b> Gris claro (RAL 9002)</p> <p><b>69'80€</b></p>
	<p><b>Conexión instrumento:</b> Midwest 4 sin luz – 4 orificios <b>Conexión equipo:</b> Abierta</p> <p><b>Origen:</b> Italia      <b>Fabricante:</b> Tekne Dental (TKD®)      <b>Garantía:</b> 12 meses</p> <p><b>Ref.:</b> <b>40-21B2000</b></p>	<p><b>Longitud:</b> 200cm <b>Color:</b> Gris oscuro (RAL 7038)</p> <p><b>69'80€</b></p>
	<p><b>Conexión instrumento:</b> Midwest 4 sin luz – 4 orificios <b>Conexión equipo:</b> Abierta</p> <p><b>Origen:</b> Italia      <b>Fabricante:</b> Tekne Dental (TKD®)      <b>Garantía:</b> 12 meses</p> <p><b>Ref.:</b> <b>40-21B3000</b></p>	<p><b>Longitud:</b> 200cm <b>Color:</b> Negro</p> <p><b>69'80€</b></p>
	<p><b>Conexión instrumento:</b> Midwest 4 sin luz – 4 orificios <b>Conexión equipo:</b> Abierta</p> <p><b>Origen:</b> Italia      <b>Fabricante:</b> Tekne Dental (TKD®)      <b>Garantía:</b> 12 meses</p> <p><b>Ref.:</b> <b>40-21B4000</b></p>	<p><b>Longitud:</b> 200cm <b>Color:</b> Blanco</p> <p><b>78'80€</b></p>

	<b>Mangueras Turbina Conexión Abierta / Open End</b>	<b>Características</b>
	<p><b>Conexión instrumento:</b> Manguera 4 vías</p> <p><b>Conexión equipo:</b> Abierta</p> <p><b>Origen:</b> EEUU      <b>Garantía:</b> 6 meses</p> <p><b>Ref.:</b> <b>40-007</b>      <b>25<sup>80</sup>€</b></p>	<p><b>Longitud:</b> 160cm - Rizada</p> <p><b>Color:</b> Gris oscuro (RAL 7035 +)</p> <p><b>HASTA AGOTAR</b></p>

Mangueras Turbina: **Conector a equipo Cefla® (desde 2006) Anthos, Stern Weber, Castellini**



	<b>Mangueras Turbina: Conector a equipo Cefla® (desde 2006)</b>	<b>Características</b>
	<p><b>Conexión instrumento:</b> Midwest 4 con luz - 6 orificios</p> <p><b>Conexión equipo Cefla® (desde 2006):</b>  <b>Anthos®:</b> A3, A5, A6, A7, A9, L6, L9, R7; <b>Stern Weber®:</b> S200, S220TR S250, S280TRC, S300, 320TR, S320TR, S380TRC;  <b>Castellini®:</b> SKEMA 5, SKEMA 6, SKEMA 8 y PUMA ELI</p> <p><b>Origen:</b> Italia      <b>Fabricante:</b> Tekne Dental (TKD®)      <b>Garantía:</b> 12 meses</p> <p><b>Ref.:</b> <b>40-12E2022</b>      <b>143<sup>80</sup>€</b></p>	<p><b>Longitud:</b> 135cm</p> <p><b>Color:</b> Gris oscuro (RAL 7038)</p>
	<p><b>Conexión instrumento:</b> Midwest 4 con luz - 6 orificios</p> <p><b>Conexión equipo Cefla® (desde 2006):</b>  <b>Anthos®:</b> A3, A5, A6, A7, A9, L6, L9, R7; <b>Stern Weber®:</b> S200, S220TR S250, S280TRC, S300, 320TR, S320TR, S380TRC;  <b>Castellini®:</b> SKEMA 5, SKEMA 6, SKEMA 8 y PUMA ELI</p> <p><b>Origen:</b> Italia      <b>Fabricante:</b> Tekne Dental (TKD®)      <b>Garantía:</b> 12 meses</p> <p><b>Ref.:</b> <b>40-12G2022</b>      <b>138<sup>80</sup>€</b></p>	<p><b>Longitud:</b> 120cm</p> <p><b>Color:</b> Gris oscuro (RAL 7038)</p>
	<p><b>Conexión instrumento:</b> Midwest 4 con luz - 6 orificios</p> <p><b>Conexión equipo Cefla® (desde 2006):</b>  <b>Anthos®:</b> A3, A5, A6, A7, A9, L6, L9, R7; <b>Stern Weber®:</b> S200, S220TR S250, S280TRC, S300, 320TR, S320TR, S380TRC;  <b>Castellini®:</b> SKEMA 5, SKEMA 6, SKEMA 8 y PUMA ELI</p> <p><b>Origen:</b> Italia      <b>Fabricante:</b> Tekne Dental (TKD®)      <b>Garantía:</b> 12 meses</p> <p><b>Ref.:</b> <b>40-12E2021</b>      <b>296<sup>80</sup>€</b></p>	<p><b>Longitud:</b> 135cm</p> <p><b>Color:</b> Gris oscuro (RAL 7038)</p> <p><b>Regulación de spray</b></p>
	<p><b>Conexión instrumento:</b> Midwest 4 con luz - 6 orificios</p> <p><b>Conexión equipo Cefla® (desde 2006):</b>  <b>Anthos®:</b> A3, A5, A6, A7, A9, L6, L9, R7; <b>Stern Weber®:</b> S200, S220TR S250, S280TRC, S300, 320TR, S320TR, S380TRC;  <b>Castellini®:</b> SKEMA 5, SKEMA 6, SKEMA 8 y PUMA ELI</p> <p><b>Origen:</b> Italia      <b>Fabricante:</b> Tekne Dental (TKD®)      <b>Garantía:</b> 12 meses</p> <p><b>Ref.:</b> <b>40-12G2021</b>      <b>299<sup>80</sup>€</b></p>	<p><b>Longitud:</b> 120cm</p> <p><b>Color:</b> Gris oscuro (RAL 7038)</p> <p><b>Regulación de spray</b></p>















Mangueras Turbina: **Conector a equipo KaVo®**



	<b>Mangueras Turbina: Conector a equipo KaVo®</b>	<b>Características</b>
	<p><b>Conexión instrumento:</b> Midwest 4 con luz - 6 orificios</p> <p><b>Conexión equipo:</b> KaVo®1057, 1058*, 1060, 1062, 1063, 1065, 1066, 1078, 1080 (*Excepto 1058 Primus Life) (Serie 1)</p> <p><b>Origen:</b> Italia      <b>Fabricante:</b> Tekne Dental (TKD®)      <b>Garantía:</b> 12 meses</p> <p><b>Ref.:</b> <b>40-12G6010</b>      <b>156<sup>80</sup>€</b></p>	<p><b>Longitud:</b> 120cm</p> <p><b>Color:</b> Gris medio (RAL 7035)</p>
	<p><b>Conexión instrumento:</b> Midwest 4 con luz - 6 orificios</p> <p><b>Conexión equipo:</b> KaVo®1057, 1058*, 1060, 1062, 1063, 1065, 1066, 1078, 1080 (*Excepto 1058 Primus Life) (Serie 1)</p> <p><b>Origen:</b> Italia      <b>Fabricante:</b> Tekne Dental (TKD®)      <b>Garantía:</b> 12 meses</p> <p><b>Ref.:</b> <b>40-12E6010</b>      <b>159<sup>80</sup>€</b></p>	<p><b>Longitud:</b> 135cm</p> <p><b>Color:</b> Gris medio (RAL 7035)</p>
	<p><b>Conexión instrumento:</b> Midwest 4 con luz - 6 orificios</p> <p><b>Conexión equipo:</b> KaVo®1057, 1058*, 1060, 1062, 1063, 1065, 1066, 1078, 1080 (*Excepto 1058 Primus Life) (Serie 1)</p> <p><b>Origen:</b> Italia      <b>Fabricante:</b> Tekne Dental (TKD®)      <b>Garantía:</b> 12 meses</p> <p><b>Ref.:</b> <b>40-12G6011</b>      <b>296<sup>80</sup>€</b></p>	<p><b>Longitud:</b> 120cm</p> <p><b>Color:</b> Gris medio (RAL 7035)</p> <p><b>Regulación de spray</b></p> <p><b>BAJO PEDIDO</b></p>

## Mangueras Turbina: Conector a equipo KaVo®

## Características

		<p><b>Conexión instrumento:</b> Midwest 4 con luz - 6 orificios</p> <p><b>Conexión equipo:</b> KaVo® 1057, 1058*, 1060, 1062, 1063, 1065, 1066, 1078, 1080 (*Excepto 1058 Primus Life) (Serie 1)</p> <p><b>Origen:</b> Italia      <b>Fabricante:</b> Tekne Dental (TKD®)      <b>Garantía:</b> 12 meses</p> <p><b>Ref.:</b> <b>40-12E6011</b>      <b>299´80€</b></p>	<p><b>Longitud:</b> 135cm</p> <p><b>Color:</b> Gris medio (RAL 7035)</p> <p><b>Regulación de spray</b></p> <p><b>BAJO PEDIDO</b></p>
		<p><b>Conexión instrumento:</b> Midwest 4 con luz - 6 orificios</p> <p><b>Conexión equipo:</b> KaVo® E30S, E30T, E50S y E70S, excepto E50T, E70T y E80T (Serie 2: sin sensor magnético)</p> <p><b>Origen:</b> Italia      <b>Fabricante:</b> Tekne Dental (TKD®)      <b>Garantía:</b> 12 meses</p> <p><b>Ref.:</b> <b>40-12G6012</b>      <b>168´00€</b></p>	<p><b>Longitud:</b> 120cm</p> <p><b>Color:</b> Gris medio (RAL 7035)</p>
		<p><b>Conexión instrumento:</b> Midwest 4 con luz - 6 orificios</p> <p><b>Conexión equipo:</b> KaVo® E30S, E30T, E50S y E70S, excepto E50T, E70T y E80T (Serie 2: sin sensor magnético)</p> <p><b>Origen:</b> Italia      <b>Fabricante:</b> Tekne Dental (TKD®)      <b>Garantía:</b> 12 meses</p> <p><b>Ref.:</b> <b>40-12E6012</b>      <b>178´00€</b></p>	<p><b>Longitud:</b> 135cm</p> <p><b>Color:</b> Gris medio (RAL 7035)</p>
		<p><b>Conexión instrumento:</b> Midwest 4 con luz - 6 orificios</p> <p><b>Conexión equipo:</b> KaVo® E30S, E30T, E50S y E70S, excepto E50T, E70T y E80T (Serie 2: sin sensor magnético)</p> <p><b>Origen:</b> Italia      <b>Fabricante:</b> Tekne Dental (TKD®)      <b>Garantía:</b> 12 meses</p> <p><b>Ref.:</b> <b>40-12G6013</b>      <b>312´80€</b></p>	<p><b>Longitud:</b> 120cm</p> <p><b>Color:</b> Gris medio (RAL 7035)</p> <p><b>Regulación de spray</b></p> <p><b>BAJO PEDIDO</b></p>
		<p><b>Conexión instrumento:</b> Midwest 4 con luz - 6 orificios</p> <p><b>Conexión equipo:</b> KaVo® E30S, E30T, E50S y E70S, excepto E50T, E70T y E80T (Serie 2: sin sensor magnético)</p> <p><b>Origen:</b> Italia      <b>Fabricante:</b> Tekne Dental (TKD®)      <b>Garantía:</b> 12 meses</p> <p><b>Ref.:</b> <b>40-12E6013</b>      <b>318´00€</b></p>	<p><b>Longitud:</b> 135cm</p> <p><b>Color:</b> Gris medio (RAL 7035)</p> <p><b>Regulación de spray</b></p> <p><b>BAJO PEDIDO</b></p>
		<p><b>Conexión instrumento:</b> Midwest 4 con luz - 6 orificios</p> <p><b>Conexión equipo:</b> KaVo® E50T, E70T, E80T y KaVo® 1058 Life + (Serie 3) (Con sensor magnético y con resistencia)</p> <p><b>Origen:</b> Italia      <b>Fabricante:</b> Tekne Dental (TKD®)      <b>Garantía:</b> 12 meses</p> <p><b>Ref.:</b> <b>40-12G6014</b>      <b>202´80€</b></p>	<p><b>Longitud:</b> 120cm</p> <p><b>Color:</b> Gris medio (RAL 7035)</p>
		<p><b>Conexión instrumento:</b> Midwest 4 con luz - 6 orificios</p> <p><b>Conexión equipo:</b> KaVo® E50T, E70T, E80T y KaVo® 1058 Life + (Serie 3) (Con sensor magnético y con resistencia)</p> <p><b>Origen:</b> Italia      <b>Fabricante:</b> Tekne Dental (TKD®)      <b>Garantía:</b> 12 meses</p> <p><b>Ref.:</b> <b>40-12E6014</b>      <b>208´00€</b></p>	<p><b>Longitud:</b> 135cm</p> <p><b>Color:</b> Gris medio (RAL 7035)</p>





## Mangueras Turbina: Conector a equipo Planmecca®

RUMAR





## Mangueras Turbina: Conector a equipo Planmecca®



## Características

		<p><b>Conexión instrumento:</b> Midwest 4 con luz - 6 orificios</p> <p><b>Conexión equipo:</b> Planmecca®</p> <p><b>Origen:</b> Italia      <b>Fabricante:</b> Tekne Dental (TKD®)      <b>Garantía:</b> 12 meses</p> <p><b>Ref.:</b> <b>40-12M1001</b> (Ref. Planmecca®: J2600265-11)      <b>196´80€</b></p>	<p><b>Longitud:</b> 103cm</p> <p><b>Color:</b> Gris claro (RAL 9002)</p> <p><b>Resistencia:</b> 820 Ohm</p>
		<p><b>Conexión instrumento:</b> Midwest 4 con luz - 6 orificios</p> <p><b>Conexión equipo:</b> Planmecca®</p> <p><b>Origen:</b> Italia      <b>Fabricante:</b> Tekne Dental (TKD®)      <b>Garantía:</b> 12 meses</p> <p><b>Ref.:</b> <b>40-12K1001</b> (Ref. Planmecca®: J2600203-8)      <b>196´80€</b></p>	<p><b>Longitud:</b> 90cm</p> <p><b>Color:</b> Gris claro (RAL 9002)</p> <p><b>Resistencia:</b> 560 Ohm</p>

**Mangueras Turbina: Conector a equipo Planmeca®**

**Características**



 	<p><b>Conexión instrumento:</b> Midwest 4 con luz - 6 orificios</p> <p><b>Conexión equipo:</b> Planmeca®</p>	<p><b>Longitud:</b> 93cm</p> <p><b>Color:</b> Gris claro (RAL 9002)</p> <p><b>Resistencia:</b> 430 Ohm</p>
	<p><b>Origen:</b> Italia      <b>Fabricante:</b> Tekne Dental (TKD®)      <b>Garantía:</b> 12 meses</p> <p><b>Ref.:</b> <b>40-12K1000</b> <span style="float: right;"><b>196<sup>80</sup>€</b></span></p>	



 	<p><b>Conexión instrumento:</b> Midwest 4 con luz - 6 orificios</p> <p><b>Conexión equipo:</b> Planmeca®</p>	<p><b>Longitud:</b> 100cm</p> <p><b>Color:</b> Gris claro (RAL 9002)</p> <p><b>Resistencia:</b> 415 Ohm</p>
	<p><b>Origen:</b> Italia      <b>Fabricante:</b> Tekne Dental (TKD®)      <b>Garantía:</b> 12 meses</p> <p><b>Ref.:</b> <b>40-12M1002</b> (Ref. Planmeca®: J2600280-6) <span style="float: right;"><b>189<sup>80</sup>€</b></span></p>	<b>BAJO PEDIDO</b>

**Mangueras Turbina: Conector a equipo Sirona®** RUMAR 

**Mangueras Turbina Conector a equipo Sirona®**

**Características**

 	<p><b>Conexión instrumento:</b> Midwest 4 con luz - 6 orificios</p> <p><b>Conexión equipo:</b> Sirona® A1, A2, A4, A5, AC, C1, C1+, C2, C2+, C4, C4+, C5+, C8, C8+, C9+, E1, E2, E4, E5, EC, M1, M1+, Profeel, Spirit, S1, S2, INTEGO, INTEGO PRO, TENEO, SINIUS.</p>	<p><b>Longitud:</b> 137cm</p> <p><b>Color:</b> Gris claro (RAL 9002)</p>
	<p><b>Origen:</b> Italia      <b>Fabricante:</b> Tekne Dental (TKD®)      <b>Garantía:</b> 12 meses</p> <p><b>Ref.:</b> <b>40-12L1000</b> (Ref. Sirona®: 6216274) <span style="float: right;"><b>191<sup>80</sup>€</b></span></p>	

 	<p><b>Conexión instrumento:</b> Midwest 4 con luz - 6 orificios</p> <p><b>Conexión equipo:</b> Sirona® C3, C3+, C6, E3.</p>	<p><b>Longitud:</b> 103cm</p> <p><b>Color:</b> Gris claro (RAL 9002)</p>
	<p><b>Origen:</b> Italia      <b>Fabricante:</b> Tekne Dental (TKD®)      <b>Garantía:</b> 12 meses</p> <p><b>Ref.:</b> <b>40-12M1000</b> (Ref. Sirona®: 8924631) <span style="float: right;"><b>191<sup>80</sup>€</b></span></p>	

## MANGUERAS PARA ULTRASONIDOS

### Mangueras para Ultrasonidos Satelec®

Conexión a equipo: **Abierta/Open end** > Cefla® > KaVo® > Planmeca® > Sirona®

### Mangueras para Ultrasonidos EMS®

Conexión a equipo: **Abierta/Open end** > Cefla® > KaVo® > Planmeca® > Sirona®

### Mangueras para Ultrasonidos KaVo®

Conexión a equipo: **Abierta/Open end** > Cefla® > KaVo® > Planmeca® > Sirona®

### Mangueras para Ultrasonidos MECTRON®

Conexión a equipo: **Abierta/Open end** > Cefla® > KaVo® > Planmeca® > Sirona®

### Mangueras Ultrasonidos TKD®

Conexión a equipo: **Abierta/Open end** > Cefla® > KaVo® > Planmeca® > Sirona®

## Mangueras para Ultrasonidos Satelec®

Conexión a equipo: **Abierta/Open end** > Cefla® > KaVo® > Planmeca® > Sirona®

### Mangueras para Ultrasonidos Satelec®: Conexión Abierta / Open End





RUMAR



	Mangueras para Ultrasonidos Satelec®: Conexión Abierta / Open End	Características
	<p><b>Conexión instrumento:</b> Satelec® Newtron/Suprasson, sin luz <b>Conexión equipo:</b> Satelec® Newtron/Suprasson, sin luz</p> <p><b>Origen:</b> Italia      <b>Fabricante:</b> Tekne Dental (TKD®)      <b>Garantía:</b> 12 meses</p> <p><b>Ref.:</b> 40-71B1111</p>	<p><b>Longitud:</b> 200cm <b>Color:</b> Gris claro (RAL 9002) <b>Diámetro:</b> 7mm (FINA)</p>
	<p><b>Conexión instrumento:</b> Satelec® Newtron/Suprasson, sin luz <b>Conexión equipo:</b> Abierta</p> <p><b>Origen:</b> Italia      <b>Fabricante:</b> Tekne Dental (TKD®)      <b>Garantía:</b> 12 meses</p> <p><b>Ref.:</b> 40-71B1100</p>	<p><b>Longitud:</b> 200cm <b>Color:</b> Gris claro (RAL 9002) <b>Diámetro:</b> 9mm (STANDARD)</p>
	<p><b>Conexión instrumento:</b> Satelec® Newtron/Suprasson, sin luz <b>Conexión equipo:</b> Abierta</p> <p><b>Origen:</b> Italia      <b>Fabricante:</b> Tekne Dental (TKD®)      <b>Garantía:</b> 12 meses</p> <p><b>Ref.:</b> 40-71B2100</p>	<p><b>Longitud:</b> 200cm <b>Color:</b> Gris oscuro (RAL 7038) <b>Diámetro:</b> 9mm (STANDARD)</p>
	<p><b>Conexión instrumento:</b> Satelec® Newtron/Suprasson, sin luz <b>Conexión equipo:</b> Abierta</p> <p><b>Origen:</b> Italia      <b>Fabricante:</b> Tekne Dental (TKD®)      <b>Garantía:</b> 12 meses</p> <p><b>Ref.:</b> 40-71B1110</p>	<p><b>Longitud:</b> 200cm <b>Color:</b> Gris claro (RAL 9002) <b>Diámetro:</b> 7mm (FINA)</p>
	<p><b>Conexión instrumento:</b> Satelec® Newtron/Suprasson, sin luz <b>Conexión equipo:</b> Abierta</p> <p><b>Origen:</b> Italia      <b>Fabricante:</b> Tekne Dental (TKD®)      <b>Garantía:</b> 12 meses</p> <p><b>Ref.:</b> 40-71B2110</p>	<p><b>Longitud:</b> 200cm <b>Color:</b> Gris oscuro (RAL 7038) <b>Diámetro:</b> 7mm (FINA)</p>

**Mangueras para Ultrasonidos Satelec®: Conexión Abierta / Open End**

**Características**

	<p><b>Conexión instrumento:</b> Satelec® Newtron/Suprasson, sin luz  <b>Conexión equipo:</b> Abierta</p> <p><b>Origen:</b> China    <b>Fabricante:</b> Woodpecker®    <b>Garantía:</b> 6 meses</p> <p><b>Ref.:</b> <b>28-U008</b></p>	<p><b>Longitud:</b> 200cm  <b>Color:</b> Gris claro (RAL 9002)  <b>Diámetro:</b> 7mm (FINA)</p> <p><b>39<sup>´</sup>80€</b></p>
	<p><b>Conexión instrumento:</b> Satelec® Newtron/Suprasson, con luz  <b>Conexión equipo:</b> Abierta</p> <p><b>Origen:</b> Italia    <b>Fabricante:</b> Tekne Dental (TKD®)    <b>Garantía:</b> 12 meses</p> <p><b>Ref.:</b> <b>40-71B1120</b></p>	<p><b>Longitud:</b> 200cm  <b>Color:</b> Gris claro (RAL 9002)  <b>Diámetro:</b> 7mm (FINA)</p> <p><b>131<sup>´</sup>80€</b></p>
	<p><b>Conexión instrumento:</b> Satelec® Newtron/Suprasson, con luz  <b>Conexión equipo:</b> Abierta</p> <p><b>Origen:</b> Italia    <b>Fabricante:</b> Tekne Dental (TKD®)    <b>Garantía:</b> 12 meses</p> <p><b>Ref.:</b> <b>40-71B1130</b></p>	<p><b>Longitud:</b> 200cm  <b>Color:</b> Gris claro (RAL 9002)  <b>Diámetro:</b> 9mm (STANDARD)</p> <p><b>131<sup>´</sup>80€</b></p>
	<p><b>Conexión instrumento:</b> Satelec® Newtron/Suprasson, con luz  <b>Conexión equipo:</b> Abierta</p> <p><b>Origen:</b> China    <b>Fabricante:</b> Woodpecker®    <b>Garantía:</b> 6 meses</p> <p><b>Ref.:</b> <b>28-U009</b></p>	<p><b>Longitud:</b> 200cm  <b>Color:</b> Gris claro (RAL 9002)  <b>Diámetro:</b> 7mm (FINA)</p> <p><b>50<sup>´</sup>80€</b></p>







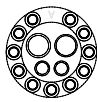

**Mangueras para Ultrasonidos Satelec®: Conector a equipo Cefla® (desde 2006) Anthos, Stern Weber, Castellini**

RUMAR

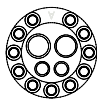



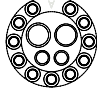



**Mangueras para Ultrasonidos Satelec®: Conector a equipo Cefla® (desde 2006)**

**Características**

 	<p><b>Conexión instrumento:</b> Satelec® Newtron/Suprasson, sin luz  <b>Conexión equipo Cefla® (desde 2006):</b>  <b>Anthos®:</b> A3, A5, A6, A7, A9, L6, L9, R7; <b>Stern Weber®:</b> S200, S220TR S250, S280TRC, S300, 320TR, S320TR, S380TRC;  <b>Castellini®:</b> SKEMA 5, SKEMA 6, SKEMA 8, PUMA ELI</p> <p><b>Origen:</b> Italia    <b>Fabricante:</b> Tekne Dental (TKD®)    <b>Garantía:</b> 12 meses</p> <p><b>Ref.:</b> <b>40-72E2100</b></p>	<p><b>Longitud:</b> 135cm  <b>Color:</b> Gris oscuro (RAL 7038)  <b>Diámetro:</b> 7mm</p> <p><b>128<sup>´</sup>00€</b></p>
 	<p><b>Conexión instrumento:</b> Satelec® Newtron/Suprasson, sin luz  <b>Conexión equipo Cefla® (desde 2006):</b>  <b>Anthos®:</b> A3, A5, A6, A7, A9, L6, L9, R7; <b>Stern Weber®:</b> S200, S220TR S250, S280TRC, S300, 320TR, S320TR, S380TRC;  <b>Castellini®:</b> SKEMA 5, SKEMA 6, SKEMA 8, PUMA ELI</p> <p><b>Origen:</b> Italia    <b>Fabricante:</b> Tekne Dental (TKD®)    <b>Garantía:</b> 12 meses</p> <p><b>Ref.:</b> <b>40-72E2110</b></p>	<p><b>Longitud:</b> 135cm  <b>Color:</b> Gris oscuro (RAL 7038)  <b>Diámetro:</b> 9mm</p> <p><b>128<sup>´</sup>00€</b></p>
 	<p><b>Conexión instrumento:</b> Satelec® Newtron/Suprasson, sin luz  <b>Conexión equipo Cefla® (desde 2006):</b>  <b>Anthos®:</b> A3, A5, A6, A7, A9, L6, L9, R7; <b>Stern Weber®:</b> S200, S220TR S250, S280TRC, S300, 320TR, S320TR, S380TRC;  <b>Castellini®:</b> SKEMA 5, SKEMA 6, SKEMA 8, PUMA ELI</p> <p><b>Origen:</b> Italia    <b>Fabricante:</b> Tekne Dental (TKD®)    <b>Garantía:</b> 12 meses</p> <p><b>Ref.:</b> <b>40-72G2100</b></p>	<p><b>Longitud:</b> 120cm  <b>Color:</b> Gris oscuro (RAL 7038)  <b>Diámetro:</b> 7mm</p> <p><b>118<sup>´</sup>00€</b></p>
 	<p><b>Conexión instrumento:</b> Satelec® Newtron/Suprasson, sin luz  <b>Conexión equipo Cefla® (desde 2006):</b>  <b>Anthos®:</b> A3, A5, A6, A7, A9, L6, L9, R7; <b>Stern Weber®:</b> S200, S220TR S250, S280TRC, S300, 320TR, S320TR, S380TRC;  <b>Castellini®:</b> SKEMA 5, SKEMA 6, SKEMA 8, PUMA ELI</p> <p><b>Origen:</b> Italia    <b>Fabricante:</b> Tekne Dental (TKD®)    <b>Garantía:</b> 12 meses</p> <p><b>Ref.:</b> <b>40-72G2110</b></p>	<p><b>Longitud:</b> 120cm  <b>Color:</b> Gris oscuro (RAL 7038)  <b>Diámetro:</b> 9mm</p> <p><b>118<sup>´</sup>00€</b></p>
 	<p><b>Conexión instrumento:</b> Satelec® Newtron/Suprasson LED, con luz  <b>Conexión equipo Cefla® (desde 2006):</b>  <b>Anthos®:</b> A3, A5, A6, A7, A9, L6, L9, R7; <b>Stern Weber®:</b> S200, S220TR S250, S280TRC, S300, 320TR, S320TR, S380TRC;  <b>Castellini®:</b> SKEMA 5, SKEMA 6, SKEMA 8 y PUMA ELI</p> <p><b>Origen:</b> Italia    <b>Fabricante:</b> Tekne Dental (TKD®)    <b>Garantía:</b> 12 meses</p> <p><b>Ref.:</b> <b>40-72E2120</b></p>	<p><b>Longitud:</b> 135cm  <b>Color:</b> Gris oscuro (RAL 7038)  <b>Diámetro:</b> 7mm</p> <p><b>188<sup>´</sup>00€</b></p>

BAJO PEDIDO













**Mangueras para Ultrasonidos Satelec®: Conector a equipo Cefla® (desde 2006) Características**

 	<p><b>Conexión instrumento:</b> Satelec® Newtron/Suprasson LED, con luz  <b>Conexión equipo Cefla® (desde 2006):</b>                  Anthos®: A3, A5, A6, A7, A9, L6, L9, R7; <b>Stern Weber®:</b> S200, S220TR S250, S280TRC, S300, 320TR, S320TR, S380TRC;                  Castellini®: SKEMA 5, SKEMA 6, SKEMA 8 y PUMA ELI  <b>Origen:</b> Italia <b>Fabricante:</b> Tekne Dental (TKD®) <b>Garantía:</b> 12 meses</p> <p><b>Ref.: 40-72E2130</b> <b>188´00€</b></p>	<p><b>Longitud:</b> 135cm  <b>Color:</b> Gris oscuro (RAL 7038)  <b>Diámetro:</b> 9mm</p> <p><b>BAJO PEDIDO</b></p>
 	<p><b>Conexión instrumento:</b> Satelec® Newtron/Suprasson LED, con luz  <b>Conexión equipo Cefla® (desde 2006):</b>                  Anthos®: A3, A5, A6, A7, A9, L6, L9, R7; <b>Stern Weber®:</b> S200, S220TR S250, S280TRC, S300, 320TR, S320TR, S380TRC;                  Castellini®: SKEMA 5, SKEMA 6, SKEMA 8 y PUMA ELI  <b>Origen:</b> Italia <b>Fabricante:</b> Tekne Dental (TKD®) <b>Garantía:</b> 12 meses</p> <p><b>Ref.: 40-72G2120</b> <b>178´00€</b></p>	<p><b>Longitud:</b> 120cm  <b>Color:</b> Gris oscuro (RAL 7038)  <b>Diámetro:</b> 7mm</p> <p><b>BAJO PEDIDO</b></p>
 	<p><b>Conexión instrumento:</b> Satelec® Newtron/Suprasson LED, con luz  <b>Conexión equipo Cefla® (desde 2006):</b>                  Anthos®: A3, A5, A6, A7, A9, L6, L9, R7; <b>Stern Weber®:</b> S200, S220TR S250, S280TRC, S300, 320TR, S320TR, S380TRC;                  Castellini®: SKEMA 5, SKEMA 6, SKEMA 8 y PUMA ELI  <b>Origen:</b> Italia <b>Fabricante:</b> Tekne Dental (TKD®) <b>Garantía:</b> 12 meses</p> <p><b>Ref.: 40-72G2130</b> <b>178´00€</b></p>	<p><b>Longitud:</b> 120cm  <b>Color:</b> Gris oscuro (RAL 7038)  <b>Diámetro:</b> 9mm</p> <p><b>BAJO PEDIDO</b></p>

**Mangueras para Ultrasonidos Satelec®: Conector a equipo KaVo®**



**Mangueras para Ultrasonidos Satelec®: Conector a equipo KaVo® Características**

 	<p><b>Conexión instrumento:</b> Satelec® Newtron/Suprasson, sin luz  <b>Conexión equipo:</b> KaVo® 1057, 1058*, 1060, 1062, 1063, 1065, 1066, 1078, 1080 (*Excepto 1058 Primus Life) (Serie 1)  <b>Origen:</b> Italia <b>Fabricante:</b> Tekne Dental (TKD®) <b>Garantía:</b> 12 meses</p> <p><b>Ref.: 40-72G6101</b> <b>128´00€</b></p>	<p><b>Longitud:</b> 120cm  <b>Color:</b> Gris medio (RAL 7035)  <b>Diámetro:</b> 9mm (STANDARD)</p> <p><b>BAJO PEDIDO</b></p>
 	<p><b>Conexión instrumento:</b> Satelec® Newtron/Suprasson, sin luz  <b>Conexión equipo:</b> KaVo® 1057, 1058*, 1060, 1062, 1063, 1065, 1066, 1078, 1080 (*Excepto 1058 Primus Life) (Serie 1)  <b>Origen:</b> Italia <b>Fabricante:</b> Tekne Dental (TKD®) <b>Garantía:</b> 12 meses</p> <p><b>Ref.: 40-72E6101</b> <b>128´00€</b></p>	<p><b>Longitud:</b> 135cm  <b>Color:</b> Gris medio (RAL 7035)  <b>Diámetro:</b> 9mm (STANDARD)</p> <p><b>BAJO PEDIDO</b></p>
 	<p><b>Conexión instrumento:</b> Satelec® Newtron/Suprasson, sin luz  <b>Conexión equipo:</b> KaVo® E30S, E30T, E50S y E70S, excepto E50T, E70T y E80T (Serie 2: sin sensor magnético)  <b>Origen:</b> Italia <b>Fabricante:</b> Tekne Dental (TKD®) <b>Garantía:</b> 12 meses</p> <p><b>Ref.: 40-72G6100</b> <b>148´00€</b></p>	<p><b>Longitud:</b> 120cm  <b>Color:</b> Gris medio (RAL 7035)  <b>Diámetro:</b> 9mm (STANDARD)</p>
 	<p><b>Conexión instrumento:</b> Satelec® Newtron/Suprasson, sin luz  <b>Conexión equipo:</b> KaVo® E30S, E30T, E50S y E70S, excepto E50T, E70T y E80T (Serie 2: sin sensor magnético)  <b>Origen:</b> Italia <b>Fabricante:</b> Tekne Dental (TKD®) <b>Garantía:</b> 12 meses</p> <p><b>Ref.: 40-72E6100</b> <b>148´00€</b></p>	<p><b>Longitud:</b> 135cm  <b>Color:</b> Gris medio (RAL 7035)  <b>Diámetro:</b> 9mm (STANDARD)</p>
 	<p><b>Conexión instrumento:</b> Satelec® Newtron/Suprasson, sin luz  <b>Conexión equipo:</b> KaVo® E50T, E70T, E80T y KaVo® 1058 Life + (Serie 3) (Con sensor magnético y con resistencia)  <b>Origen:</b> Italia <b>Fabricante:</b> Tekne Dental (TKD®) <b>Garantía:</b> 12 meses</p> <p><b>Ref.: 40-72G6102</b> <b>198´00€</b></p>	<p><b>Longitud:</b> 120cm  <b>Color:</b> Gris medio (RAL 7035)  <b>Diámetro:</b> 9mm (STANDARD)</p> <p><b>BAJO PEDIDO</b></p>
 	<p><b>Conexión instrumento:</b> Satelec® Newtron/Suprasson, sin luz  <b>Conexión equipo:</b> KaVo® E50T, E70T, E80T y KaVo® 1058 Life + (Serie 3) (Con sensor magnético y con resistencia)  <b>Origen:</b> Italia <b>Fabricante:</b> Tekne Dental (TKD®) <b>Garantía:</b> 12 meses</p> <p><b>Ref.: 40-72E6102</b> <b>202´80€</b></p>	<p><b>Longitud:</b> 135cm  <b>Color:</b> Gris medio (RAL 7035)  <b>Diámetro:</b> 9mm (STANDARD)</p> <p><b>BAJO PEDIDO</b></p>

**Mangueras para Ultrasonidos Satelec®: Conector a equipo KaVo®**

**Características**

	<p><b>Conexión instrumento:</b> Satelec® Newtron/Suprasson, con luz  <b>Conexión equipo:</b> KaVo® 1057, 1058*, 1060, 1062, 1063, 1065, 1066, 1078, 1080 (*Excepto 1058 Primus Life) (Serie 1)  <b>Origen:</b> Italia <b>Fabricante:</b> Tekne Dental (TKD®) <b>Garantía:</b> 12 meses</p>	<p><b>Longitud:</b> 120cm  <b>Color:</b> Gris medio (RAL 7035)  <b>Diámetro:</b> 9mm (STANDARD)</p>
	<p><b>Conexión instrumento:</b> Satelec® Newtron/Suprasson, con luz  <b>Conexión equipo:</b> KaVo® 1057, 1058*, 1060, 1062, 1063, 1065, 1066, 1078, 1080 (*Excepto 1058 Primus Life) (Serie 1)  <b>Origen:</b> Italia <b>Fabricante:</b> Tekne Dental (TKD®) <b>Garantía:</b> 12 meses</p>	<p><b>Longitud:</b> 135cm  <b>Color:</b> Gris medio (RAL 7035)  <b>Diámetro:</b> 9mm (STANDARD)</p>
	<p><b>Conexión instrumento:</b> Satelec® Newtron/Suprasson, con luz  <b>Conexión equipo:</b> KaVo® E30S, E30T, E50S y E70S, excepto E50T, E70T y E80T (Serie 2: sin sensor magnético)  <b>Origen:</b> Italia <b>Fabricante:</b> Tekne Dental (TKD®) <b>Garantía:</b> 12 meses</p>	<p><b>Longitud:</b> 120cm  <b>Color:</b> Gris medio (RAL 7035)  <b>Diámetro:</b> 9mm (STANDARD)</p>
	<p><b>Conexión instrumento:</b> Satelec® Newtron/Suprasson, con luz  <b>Conexión equipo:</b> KaVo® E30S, E30T, E50S y E70S, excepto E50T, E70T y E80T (Serie 2: sin sensor magnético)  <b>Origen:</b> Italia <b>Fabricante:</b> Tekne Dental (TKD®) <b>Garantía:</b> 12 meses</p>	<p><b>Longitud:</b> 135cm  <b>Color:</b> Gris medio (RAL 7035)  <b>Diámetro:</b> 9mm (STANDARD)</p>
	<p><b>Conexión instrumento:</b> Satelec® Newtron/Suprasson, con luz  <b>Conexión equipo:</b> KaVo® E50T, E70T, E80T y KaVo® 1058 Life + (Serie 3) (Con sensor magnético y con resistencia)  <b>Origen:</b> Italia <b>Fabricante:</b> Tekne Dental (TKD®) <b>Garantía:</b> 12 meses</p>	<p><b>Longitud:</b> 120cm  <b>Color:</b> Gris medio (RAL 7035)  <b>Diámetro:</b> 9mm (STANDARD)</p>
	<p><b>Conexión instrumento:</b> Satelec® Newtron/Suprasson, con luz  <b>Conexión equipo:</b> KaVo® E50T, E70T, E80T y KaVo® 1058 Life + (Serie 3) (Con sensor magnético y con resistencia)  <b>Origen:</b> Italia <b>Fabricante:</b> Tekne Dental (TKD®) <b>Garantía:</b> 12 meses</p>	<p><b>Longitud:</b> 135cm  <b>Color:</b> Gris medio (RAL 7035)  <b>Diámetro:</b> 9mm (STANDARD)</p>

**Mangueras para Ultrasonidos Satelec®: Conector a equipo Planmeca®**



**Mangueras para Ultrasonidos Satelec®: Conector a equipo Planmeca®**

**Características**

	<p><b>Conexión instrumento:</b> Satelec® Newtron/Suprasson, sin luz  <b>Conexión equipo:</b> Planmeca®  <b>Origen:</b> Italia <b>Fabricante:</b> Tekne Dental (TKD®) <b>Garantía:</b> 12 meses</p>	<p><b>Color:</b> Gris claro (RAL 9002)  <b>Diámetro:</b> 7mm</p>
	<p><b>Conexión instrumento:</b> Satelec® Newtron/Suprasson, sin luz  <b>Conexión equipo:</b> Planmeca®  <b>Origen:</b> Italia <b>Fabricante:</b> Tekne Dental (TKD®) <b>Garantía:</b> 12 meses</p>	<p><b>Color:</b> Gris claro (RAL 9002)  <b>Diámetro:</b> 9mm</p>
	<p><b>Conexión instrumento:</b> Satelec® Newtron/Suprasson LED, con luz  <b>Conexión equipo:</b> Planmeca®  <b>Origen:</b> Italia <b>Fabricante:</b> Tekne Dental (TKD®) <b>Garantía:</b> 12 meses</p>	<p><b>Color:</b> Gris claro (RAL 9002)  <b>Diámetro:</b> 7mm</p>

**Mangueras para Ultrasonidos Satelec®: Conector a equipo Planmeca®**

**Características**

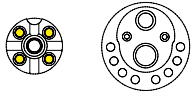

**Conexión instrumento:** Satelec® Newtron/Suprasson LED, con luz  
**Conexión equipo:** Planmeca®

**Origen:** Italia **Fabricante:** Tekne Dental (TKD®) **Garantía:** 12 meses

**Ref.:** 40-72K1130 (Ref. Planmeca®: J10021294-15)

218<sup>80</sup>€

**Color:** Gris claro (RAL 9002)  
**Diámetro:** 9mm

BAJO PEDIDO

# Mangueras para Ultrasonidos EMS®

Conexión a equipo: **Abierta / Open end** > Cefla® > KaVo® > Planmeca® > Sirona®

## Mangueras para Ultrasonidos EMS®: Conexión Abierta / Open End

RUMAR

**Mangueras para Ultrasonidos EMS®: Conexión Abierta / Open End**

**Características**

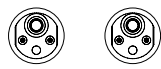

**Conexión instrumento:** EMS® Piezon, sin luz  
**Conexión equipo:** EMS Piezon, sin luz

**Origen:** Italia **Fabricante:** Tekne Dental (TKD®) **Garantía:** 12 meses

**Ref.:** 40-71B1211

141<sup>80</sup>€

**Longitud:** 200cm  
**Color:** Gris claro (RAL 9002)  
**Diámetro:** 7mm (FINA)



**Conexión instrumento:** EMS® Piezon, sin luz  
**Conexión equipo:** Abierta

**Origen:** Italia **Fabricante:** Tekne Dental (TKD®) **Garantía:** 12 meses

**Ref.:** 40-71B1200

84<sup>80</sup>€

**Longitud:** 200cm  
**Color:** Gris claro (RAL 9002)  
**Diámetro:** 9mm (STANDARD)



**Conexión instrumento:** EMS® Piezon, sin luz  
**Conexión equipo:** Abierta

**Origen:** Italia **Fabricante:** Tekne Dental (TKD®) **Garantía:** 12 meses

**Ref.:** 40-71B1201

219<sup>80</sup>€

**Longitud:** 200cm  
**Color:** Gris claro (RAL 9002)  
**Diámetro:** 9mm (STANDARD)  
**Regulación de spray**

BAJO PEDIDO



**Conexión instrumento:** EMS® Piezon, sin luz  
**Conexión equipo:** Abierta

**Origen:** Italia **Fabricante:** Tekne Dental (TKD®) **Garantía:** 12 meses

**Ref.:** 40-71B2200

84<sup>80</sup>€

**Longitud:** 200cm  
**Color:** Gris oscuro (RAL 7038)  
**Diámetro:** 9mm (STANDARD)



**Conexión instrumento:** EMS® Piezon, sin luz  
**Conexión equipo:** Abierta

**Origen:** Italia **Fabricante:** Tekne Dental (TKD®) **Garantía:** 12 meses

**Ref.:** 40-71B1210

84<sup>80</sup>€

**Longitud:** 200cm  
**Color:** Gris claro (RAL 9002)  
**Diámetro:** 7mm (FINA)



**Conexión instrumento:** EMS® Piezon, sin luz  
**Conexión equipo:** Abierta

**Origen:** Italia **Fabricante:** Tekne Dental (TKD®) **Garantía:** 12 meses

**Ref.:** 40-71B1212

219<sup>80</sup>€

**Longitud:** 200cm  
**Color:** Gris claro (RAL 9002)  
**Diámetro:** 7mm (FINA)  
**Regulación de spray**

BAJO PEDIDO



**Conexión instrumento:** EMS® Piezon, sin luz  
**Conexión equipo:** Abierta

**Origen:** Italia **Fabricante:** Tekne Dental (TKD®) **Garantía:** 12 meses









**Ref.:** 40-71B2210

84<sup>80</sup>€

**Longitud:** 200cm  
**Color:** Gris oscuro (RAL 7038)  
**Diámetro:** 7mm (FINA)

**Mangueras para Ultrasonidos EMS®: Conexión Abierta / Open End**

**Características**







 	<p><b>Conexión instrumento:</b> EMS® Piezon, sin luz  <b>Conexión equipo:</b> Abierta</p> <p><b>Origen:</b> China      <b>Fabricante:</b> Woodpecker®      <b>Garantía:</b> 6 meses</p> <p><b>Ref.: 28-U007</b> <span style="float: right;"><b>39<sup>´</sup>80€</b></span></p>	<p><b>Longitud:</b> 200cm  <b>Color:</b> Gris claro (RAL 9002)  <b>Diámetro:</b> 7mm (FINA)</p>
	<p><b>Conexión instrumento:</b> EMS® Piezon, con luz  <b>Conexión equipo:</b> Abierta</p> <p><b>Origen:</b> Italia      <b>Fabricante:</b> Tekne Dental (TKD®)      <b>Garantía:</b> 12 meses</p> <p><b>Ref.: 40-71B1220</b> <span style="float: right;"><b>131<sup>´</sup>80€</b></span></p>	<p><b>Longitud:</b> 200cm  <b>Color:</b> Gris claro (RAL 9002)  <b>Diámetro:</b> 7mm (FINA)</p>
	<p><b>Conexión instrumento:</b> EMS® Piezon, con luz  <b>Conexión equipo:</b> Abierta</p> <p><b>Origen:</b> Italia      <b>Fabricante:</b> Tekne Dental (TKD®)      <b>Garantía:</b> 12 meses</p> <p><b>Ref.: 40-71B1221</b> <span style="float: right;"><b>189<sup>´</sup>80€</b></span></p>	<p><b>Longitud:</b> 200cm  <b>Color:</b> Gris claro (RAL 9002)  <b>Diámetro:</b> 7mm (FINA)  <b>Regulación de spray</b></p> <p style="text-align: right;"><b>BAJO PEDIDO</b></p>
	<p><b>Conexión instrumento:</b> EMS® Piezon, con luz  <b>Conexión equipo:</b> Abierta</p> <p><b>Origen:</b> Italia      <b>Fabricante:</b> Tekne Dental (TKD®)      <b>Garantía:</b> 12 meses</p> <p><b>Ref.: 40-71B1230</b> <span style="float: right;"><b>131<sup>´</sup>80€</b></span></p>	<p><b>Longitud:</b> 200cm  <b>Color:</b> Gris claro (RAL 9002)  <b>Diámetro:</b> 9mm (STANDARD)</p>
	<p><b>Conexión instrumento:</b> EMS® Piezon, con luz  <b>Conexión equipo:</b> Abierta</p> <p><b>Origen:</b> Italia      <b>Fabricante:</b> Tekne Dental (TKD®)      <b>Garantía:</b> 12 meses</p> <p><b>Ref.: 40-71B1231</b> <span style="float: right;"><b>189<sup>´</sup>80€</b></span></p>	<p><b>Longitud:</b> 200cm  <b>Color:</b> Gris claro (RAL 9002)  <b>Diámetro:</b> 9mm (STANDARD)  <b>Regulación de spray</b></p> <p style="text-align: right;"><b>BAJO PEDIDO</b></p>
 	<p><b>Conexión instrumento:</b> EMS® Piezon, con luz  <b>Conexión equipo:</b> Abierta</p> <p><b>Origen:</b> China      <b>Fabricante:</b> Woodpecker®      <b>Garantía:</b> 6 meses</p> <p><b>Ref.: 28-U010</b> <span style="float: right;"><b>50<sup>´</sup>80€</b></span></p>	<p><b>Longitud:</b> 200cm  <b>Color:</b> Gris claro (RAL 9002)  <b>Diámetro:</b> 7mm (FINA)</p>

**Mangueras para Ultrasonidos EMS®: Conector a equipo Cefla® (desde 2006) Anthos, Stern Weber, Castellini**



**Mangueras para Ultrasonidos EMS®: Conector a equipo Cefla® (desde 2006)**

**Características**

 	<p><b>Conexión instrumento:</b> EMS Piezon, sin luz  <b>Conexión equipo Cefla® (desde 2006):</b>  <b>Anthos®:</b> A3, A5, A6, A7, A9, L6, L9, R7; <b>Stern Weber®:</b> S200, S220TR S250, S280TRC, S300, 320TR, S320TR, S380TRC;  <b>Castellini®:</b> SKEMA 5, SKEMA 6, SKEMA 8, PUMA ELI</p> <p><b>Origen:</b> Italia      <b>Fabricante:</b> Tekne Dental (TKD®)      <b>Garantía:</b> 12 meses</p> <p><b>Ref.: 40-72E2200</b> <span style="float: right;"><b>128<sup>´</sup>00€</b></span></p>	<p><b>Longitud:</b> 135cm  <b>Color:</b> Gris claro (RAL 7038)  <b>Diámetro:</b> 7mm</p>
 	<p><b>Conexión instrumento:</b> EMS Piezon, sin luz  <b>Conexión equipo Cefla® (desde 2006):</b>  <b>Anthos®:</b> A3, A5, A6, A7, A9, L6, L9, R7; <b>Stern Weber®:</b> S200, S220TR S250, S280TRC, S300, 320TR, S320TR, S380TRC;  <b>Castellini®:</b> SKEMA 5, SKEMA 6, SKEMA 8, PUMA ELI</p> <p><b>Origen:</b> Italia      <b>Fabricante:</b> Tekne Dental (TKD®)      <b>Garantía:</b> 12 meses</p> <p><b>Ref.: 40-72E2210</b> <span style="float: right;"><b>128<sup>´</sup>00€</b></span></p>	<p><b>Longitud:</b> 135cm  <b>Color:</b> Gris oscuro (RAL 7038)  <b>Diámetro:</b> 9mm</p>
 	<p><b>Conexión instrumento:</b> EMS Piezon, sin luz  <b>Conexión equipo Cefla® (desde 2006):</b>  <b>Anthos®:</b> A3, A5, A6, A7, A9, L6, L9, R7; <b>Stern Weber®:</b> S200, S220TR S250, S280TRC, S300, 320TR, S320TR, S380TRC;  <b>Castellini®:</b> SKEMA 5, SKEMA 6, SKEMA 8, PUMA ELI</p> <p><b>Origen:</b> Italia      <b>Fabricante:</b> Tekne Dental (TKD®)      <b>Garantía:</b> 12 meses</p> <p><b>Ref.: 40-72G2200</b> <span style="float: right;"><b>108<sup>´</sup>00€</b></span></p>	<p><b>Longitud:</b> 120cm  <b>Color:</b> Gris oscuro (RAL 7038)  <b>Diámetro:</b> 7mm</p>





















## Mangueras para Ultrasonidos EMS®: Conector a equipo Cefla® (desde 2006)

## Características

	<p><b>Conexión instrumento:</b> EMS Piezon, sin luz</p> <p><b>Conexión equipo Cefla® (desde 2006):</b>  <b>Anthos®:</b> A3, A5, A6, A7, A9, L6, L9, R7; <b>Stern Weber®:</b> S200, S220TR S250, S280TRC, S300, 320TR, S320TR, S380TRC;  <b>Castellini®:</b> SKEMA 5, SKEMA 6, SKEMA 8, PUMA ELI</p> <p><b>Origen:</b> Italia      <b>Fabricante:</b> Tekne Dental (TKD®)      <b>Garantía:</b> 12 meses</p> <p><b>Ref.: 40-72G2210</b> <span style="float: right;"><b>108<sup>00</sup>€</b></span></p>	<p><b>Longitud:</b> 120cm  <b>Color:</b> Gris oscuro (RAL 7038)  <b>Diámetro:</b> 9mm</p>
	<p><b>Conexión instrumento:</b> EMS Piezon LED, con luz</p> <p><b>Conexión equipo Cefla® (desde 2006):</b>  <b>Anthos®:</b> A3, A5, A6, A7, A9, L6, L9, R7; <b>Stern Weber®:</b> S200, S220TR S250, S280TRC, S300, 320TR, S320TR, S380TRC;  <b>Castellini®:</b> SKEMA 5, SKEMA 6, SKEMA 8 y PUMA ELI</p> <p><b>Origen:</b> Italia      <b>Fabricante:</b> Tekne Dental (TKD®)      <b>Garantía:</b> 12 meses</p> <p><b>Ref.: 40-72E2220</b> <span style="float: right;"><b>178<sup>00</sup>€</b></span></p>	<p><b>Longitud:</b> 135cm  <b>Color:</b> Gris oscuro (RAL 7038)  <b>Diámetro:</b> 7mm</p> <p style="text-align: right;"><b>BAJO PEDIDO</b></p>
	<p><b>Conexión instrumento:</b> EMS Piezon LED, con luz</p> <p><b>Conexión equipo Cefla® (desde 2006):</b>  <b>Anthos®:</b> A3, A5, A6, A7, A9, L6, L9, R7; <b>Stern Weber®:</b> S200, S220TR S250, S280TRC, S300, 320TR, S320TR, S380TRC;  <b>Castellini®:</b> SKEMA 5, SKEMA 6, SKEMA 8 y PUMA ELI</p> <p><b>Origen:</b> Italia      <b>Fabricante:</b> Tekne Dental (TKD®)      <b>Garantía:</b> 12 meses</p> <p><b>Ref.: 40-72E2230</b> <span style="float: right;"><b>178<sup>00</sup>€</b></span></p>	<p><b>Longitud:</b> 135cm  <b>Color:</b> Gris oscuro (RAL 7038)  <b>Diámetro:</b> 9mm</p> <p style="text-align: right;"><b>BAJO PEDIDO</b></p>
	<p><b>Conexión instrumento:</b> EMS Piezon LED, con luz</p> <p><b>Conexión equipo Cefla® (desde 2006):</b>  <b>Anthos®:</b> A3, A5, A6, A7, A9, L6, L9, R7; <b>Stern Weber®:</b> S200, S220TR S250, S280TRC, S300, 320TR, S320TR, S380TRC;  <b>Castellini®:</b> SKEMA 5, SKEMA 6, SKEMA 8 y PUMA ELI</p> <p><b>Origen:</b> Italia      <b>Fabricante:</b> Tekne Dental (TKD®)      <b>Garantía:</b> 12 meses</p> <p><b>Ref.: 40-72G2220</b> <span style="float: right;"><b>178<sup>00</sup>€</b></span></p>	<p><b>Longitud:</b> 120cm  <b>Color:</b> Gris oscuro (RAL 7038)  <b>Diámetro:</b> 7mm</p> <p style="text-align: right;"><b>BAJO PEDIDO</b></p>
	<p><b>Conexión instrumento:</b> EMS Piezon LED, con luz</p> <p><b>Conexión equipo Cefla® (desde 2006):</b>  <b>Anthos®:</b> A3, A5, A6, A7, A9, L6, L9, R7; <b>Stern Weber®:</b> S200, S220TR S250, S280TRC, S300, 320TR, S320TR, S380TRC;  <b>Castellini®:</b> SKEMA 5, SKEMA 6, SKEMA 8 y PUMA ELI</p> <p><b>Origen:</b> Italia      <b>Fabricante:</b> Tekne Dental (TKD®)      <b>Garantía:</b> 12 meses</p> <p><b>Ref.: 40-72G2230</b> <span style="float: right;"><b>178<sup>80</sup>€</b></span></p>	<p><b>Longitud:</b> 120cm  <b>Color:</b> Gris oscuro (RAL 7038)  <b>Diámetro:</b> 9mm</p> <p style="text-align: right;"><b>BAJO PEDIDO</b></p>
	<p><b>Conexión instrumento:</b> EMS Piezon LED, con luz</p> <p><b>Conexión equipo Cefla® (desde 2006):</b>  <b>Anthos®:</b> A3, A5, A6, A7, A9, L6, L9, R7; <b>Stern Weber®:</b> S200, S220TR S250, S280TRC, S300, 320TR, S320TR, S380TRC;  <b>Castellini®:</b> SKEMA 5, SKEMA 6, SKEMA 8 y PUMA ELI</p> <p><b>Origen:</b> Italia      <b>Fabricante:</b> Tekne Dental (TKD®)      <b>Garantía:</b> 12 meses</p> <p><b>Ref.: 40-72E2221</b> <span style="float: right;"><b>298<sup>00</sup>€</b></span></p>	<p><b>Longitud:</b> 135cm  <b>Color:</b> Gris oscuro (RAL 7038)  <b>Regulación de spray</b>  <b>Diámetro:</b> 7mm</p> <p style="text-align: right;"><b>BAJO PEDIDO</b></p>
	<p><b>Conexión instrumento:</b> EMS Piezon LED, con luz</p> <p><b>Conexión equipo Cefla® (desde 2006):</b>  <b>Anthos®:</b> A3, A5, A6, A7, A9, L6, L9, R7; <b>Stern Weber®:</b> S200, S220TR S250, S280TRC, S300, 320TR, S320TR, S380TRC;  <b>Castellini®:</b> SKEMA 5, SKEMA 6, SKEMA 8 y PUMA ELI</p> <p><b>Origen:</b> Italia      <b>Fabricante:</b> Tekne Dental (TKD®)      <b>Garantía:</b> 12 meses</p> <p><b>Ref.: 40-72E2231</b> <span style="float: right;"><b>298<sup>00</sup>€</b></span></p>	<p><b>Longitud:</b> 135cm  <b>Color:</b> Gris oscuro (RAL 7038)  <b>Regulación de spray</b>  <b>Diámetro:</b> 9mm</p> <p style="text-align: right;"><b>BAJO PEDIDO</b></p>
	<p><b>Conexión instrumento:</b> EMS Piezon LED, con luz</p> <p><b>Conexión equipo Cefla® (desde 2006):</b>  <b>Anthos®:</b> A3, A5, A6, A7, A9, L6, L9, R7; <b>Stern Weber®:</b> S200, S220TR S250, S280TRC, S300, 320TR, S320TR, S380TRC;  <b>Castellini®:</b> SKEMA 5, SKEMA 6, SKEMA 8 y PUMA ELI</p> <p><b>Origen:</b> Italia      <b>Fabricante:</b> Tekne Dental (TKD®)      <b>Garantía:</b> 12 meses</p> <p><b>Ref.: 40-72G2221</b> <span style="float: right;"><b>298<sup>00</sup>€</b></span></p>	<p><b>Longitud:</b> 120cm  <b>Color:</b> Gris oscuro (RAL 7038)  <b>Regulación de spray</b>  <b>Diámetro:</b> 7mm</p> <p style="text-align: right;"><b>BAJO PEDIDO</b></p>
	<p><b>Conexión instrumento:</b> EMS Piezon LED, con luz</p> <p><b>Conexión equipo Cefla® (desde 2006):</b>  <b>Anthos®:</b> A3, A5, A6, A7, A9, L6, L9, R7; <b>Stern Weber®:</b> S200, S220TR S250, S280TRC, S300, 320TR, S320TR, S380TRC;  <b>Castellini®:</b> SKEMA 5, SKEMA 6, SKEMA 8 y PUMA ELI</p> <p><b>Origen:</b> Italia      <b>Fabricante:</b> Tekne Dental (TKD®)      <b>Garantía:</b> 12 meses</p> <p><b>Ref.: 40-72G2231</b> <span style="float: right;"><b>298<sup>00</sup>€</b></span></p>	<p><b>Longitud:</b> 120cm  <b>Color:</b> Gris oscuro (RAL 7038)  <b>Regulación de spray</b>  <b>Diámetro:</b> 9mm</p> <p style="text-align: right;"><b>BAJO PEDIDO</b></p>





















## Mangueras para Ultrasonidos EMS®: Conector a equipo KaVo®

## Características

		<p><b>Conexión instrumento:</b> EMS Piezon, sin luz</p> <p><b>Conexión equipo:</b> KaVo® 1057, 1058*, 1060, 1062, 1063, 1065, 1066, 1078, 1080 (*Excepto 1058 Primus Life) (Serie 1)</p> <p><b>Origen:</b> Italia      <b>Fabricante:</b> Tekne Dental (TKD®)      <b>Garantía:</b> 12 meses</p> <p><b>Ref.:</b> <b>40-72G6201</b>      <b>128<sup>00</sup>€</b></p>	<p><b>Longitud:</b> 120cm</p> <p><b>Color:</b> Gris medio (RAL 7035)</p> <p><b>Diámetro:</b> 9mm (STANDARD)</p> <p><b>BAJO PEDIDO</b></p>
		<p><b>Conexión instrumento:</b> EMS Piezon, sin luz</p> <p><b>Conexión equipo:</b> KaVo® 1057, 1058*, 1060, 1062, 1063, 1065, 1066, 1078, 1080 (*Excepto 1058 Primus Life) (Serie 1)</p> <p><b>Origen:</b> Italia      <b>Fabricante:</b> Tekne Dental (TKD®)      <b>Garantía:</b> 12 meses</p> <p><b>Ref.:</b> <b>40-72E6201</b>      <b>128<sup>00</sup>€</b></p>	<p><b>Longitud:</b> 135cm</p> <p><b>Color:</b> Gris medio (RAL 7035)</p> <p><b>Diámetro:</b> 9mm (STANDARD)</p> <p><b>BAJO PEDIDO</b></p>
		<p><b>Conexión instrumento:</b> EMS Piezon, sin luz</p> <p><b>Conexión equipo:</b> KaVo® 1057, 1058*, 1060, 1062, 1063, 1065, 1066, 1078, 1080 (*Excepto 1058 Primus Life) (Serie 1)</p> <p><b>Origen:</b> Italia      <b>Fabricante:</b> Tekne Dental (TKD®)      <b>Garantía:</b> 12 meses</p> <p><b>Ref.:</b> <b>40-72G6202</b>      <b>288<sup>00</sup>€</b></p>	<p><b>Longitud:</b> 120cm</p> <p><b>Color:</b> Gris medio (RAL 7035)</p> <p><b>Diámetro:</b> 9mm (STANDARD)</p> <p><b>Regulación de spray</b></p> <p><b>BAJO PEDIDO</b></p>
		<p><b>Conexión instrumento:</b> EMS Piezon, sin luz</p> <p><b>Conexión equipo:</b> KaVo® 1057, 1058*, 1060, 1062, 1063, 1065, 1066, 1078, 1080 (*Excepto 1058 Primus Life) (Serie 1)</p> <p><b>Origen:</b> Italia      <b>Fabricante:</b> Tekne Dental (TKD®)      <b>Garantía:</b> 12 meses</p> <p><b>Ref.:</b> <b>40-72E6202</b>      <b>288<sup>00</sup>€</b></p>	<p><b>Longitud:</b> 135cm</p> <p><b>Color:</b> Gris medio (RAL 7035)</p> <p><b>Diámetro:</b> 9mm (STANDARD)</p> <p><b>Regulación de spray</b></p> <p><b>BAJO PEDIDO</b></p>
		<p><b>Conexión instrumento:</b> EMS Piezon, sin luz</p> <p><b>Conexión equipo:</b> KaVo® E30S, E30T, E50S y E70S, excepto E50T, E70T y E80T (Serie 2: sin sensor magnético)</p> <p><b>Origen:</b> Italia      <b>Fabricante:</b> Tekne Dental (TKD®)      <b>Garantía:</b> 12 meses</p> <p><b>Ref.:</b> <b>40-72G6200</b>      <b>138<sup>00</sup>€</b></p>	<p><b>Longitud:</b> 120cm</p> <p><b>Color:</b> Gris medio (RAL 7035)</p> <p><b>Diámetro:</b> 9mm (STANDARD)</p> <p><b>BAJO PEDIDO</b></p>
		<p><b>Conexión instrumento:</b> EMS Piezon, sin luz</p> <p><b>Conexión equipo:</b> KaVo® E30S, E30T, E50S y E70S, excepto E50T, E70T y E80T (Serie 2: sin sensor magnético)</p> <p><b>Origen:</b> Italia      <b>Fabricante:</b> Tekne Dental (TKD®)      <b>Garantía:</b> 12 meses</p> <p><b>Ref.:</b> <b>40-72E6200</b>      <b>138<sup>00</sup>€</b></p>	<p><b>Longitud:</b> 135cm</p> <p><b>Color:</b> Gris medio (RAL 7035)</p> <p><b>Diámetro:</b> 9mm (STANDARD)</p> <p><b>BAJO PEDIDO</b></p>
		<p><b>Conexión instrumento:</b> EMS Piezon, sin luz</p> <p><b>Conexión equipo:</b> KaVo® E30S, E30T, E50S y E70S, excepto E50T, E70T y E80T (Serie 2: sin sensor magnético)</p> <p><b>Origen:</b> Italia      <b>Fabricante:</b> Tekne Dental (TKD®)      <b>Garantía:</b> 12 meses</p> <p><b>Ref.:</b> <b>40-72G6203</b>      <b>299<sup>80</sup>€</b></p>	<p><b>Longitud:</b> 120cm</p> <p><b>Color:</b> Gris medio (RAL 7035)</p> <p><b>Diámetro:</b> 9mm (STANDARD)</p> <p><b>Regulación de spray</b></p> <p><b>BAJO PEDIDO</b></p>
		<p><b>Conexión instrumento:</b> EMS Piezon, sin luz</p> <p><b>Conexión equipo:</b> KaVo® E30S, E30T, E50S y E70S, excepto E50T, E70T y E80T (Serie 2: sin sensor magnético)</p> <p><b>Origen:</b> Italia      <b>Fabricante:</b> Tekne Dental (TKD®)      <b>Garantía:</b> 12 meses</p> <p><b>Ref.:</b> <b>40-72E6203</b>      <b>299<sup>80</sup>€</b></p>	<p><b>Longitud:</b> 135cm</p> <p><b>Color:</b> Gris medio (RAL 7035)</p> <p><b>Diámetro:</b> 9mm (STANDARD)</p> <p><b>Regulación de spray</b></p> <p><b>BAJO PEDIDO</b></p>
		<p><b>Conexión instrumento:</b> EMS Piezon, sin luz</p> <p><b>Conexión equipo:</b> KaVo® E50T, E70T, E80T y KaVo® 1058 Life + (Serie 3) (Con sensor magnético y con resistencia)</p> <p><b>Origen:</b> Italia      <b>Fabricante:</b> Tekne Dental (TKD®)      <b>Garantía:</b> 12 meses</p> <p><b>Ref.:</b> <b>40-72G6204</b>      <b>198<sup>00</sup>€</b></p>	<p><b>Longitud:</b> 120cm</p> <p><b>Color:</b> Gris medio (RAL 7035)</p> <p><b>Diámetro:</b> 9mm (STANDARD)</p> <p><b>BAJO PEDIDO</b></p>
		<p><b>Conexión instrumento:</b> EMS Piezon, sin luz</p> <p><b>Conexión equipo:</b> KaVo® E50T, E70T, E80T y KaVo® 1058 Life + (Serie 3) (Con sensor magnético y con resistencia)</p> <p><b>Origen:</b> Italia      <b>Fabricante:</b> Tekne Dental (TKD®)      <b>Garantía:</b> 12 meses</p> <p><b>Ref.:</b> <b>40-72E6204</b>      <b>202<sup>80</sup>€</b></p>	<p><b>Longitud:</b> 135cm</p> <p><b>Color:</b> Gris medio (RAL 7035)</p> <p><b>Diámetro:</b> 9mm (STANDARD)</p> <p><b>BAJO PEDIDO</b></p>









## Mangueras para Ultrasonidos EMS®: Conector a equipo KaVo®

## Características

 	<p><b>Conexión instrumento:</b> EMS Piezon, sin luz  <b>Conexión equipo:</b> KaVo® E50T, E70T, E80T y KaVo® 1058 Life + (Serie 3) (Con sensor magnético y con resistencia)</p> <p><b>Origen:</b> Italia      <b>Fabricante:</b> Tekne Dental (TKD®)      <b>Garantía:</b> 12 meses</p> <p><b>Ref.:</b> <b>40-72G6205</b>      <b>334<sup>´</sup>80€</b></p>	<p><b>Longitud:</b> 120cm  <b>Color:</b> Gris medio (RAL 7035)  <b>Diámetro:</b> 9mm (STANDARD)  <b>Regulación de spray</b></p> <p><b>BAJO PEDIDO</b></p>
 	<p><b>Conexión instrumento:</b> EMS Piezon, sin luz  <b>Conexión equipo:</b> KaVo® E50T, E70T, E80T y KaVo® 1058 Life + (Serie 3) (Con sensor magnético y con resistencia)</p> <p><b>Origen:</b> Italia      <b>Fabricante:</b> Tekne Dental (TKD®)      <b>Garantía:</b> 12 meses</p> <p><b>Ref.:</b> <b>40-72E6205</b>      <b>339<sup>´</sup>80€</b></p>	<p><b>Longitud:</b> 135cm  <b>Color:</b> Gris medio (RAL 7035)  <b>Diámetro:</b> 9mm (STANDARD)  <b>Regulación de spray</b></p> <p><b>BAJO PEDIDO</b></p>
 	<p><b>Conexión instrumento:</b> EMS Piezon, con luz  <b>Conexión equipo:</b> KaVo® 1057, 1058*, 1060, 1062, 1063, 1065, 1066, 1078, 1080 (*Excepto 1058 Primus Life) (Serie 1)</p> <p><b>Origen:</b> Italia      <b>Fabricante:</b> Tekne Dental (TKD®)      <b>Garantía:</b> 12 meses</p> <p><b>Ref.:</b> <b>40-72G6221</b>      <b>178<sup>´</sup>00€</b></p>	<p><b>Longitud:</b> 120cm  <b>Color:</b> Gris medio (RAL 7035)  <b>Diámetro:</b> 9mm (STANDARD)</p> <p><b>BAJO PEDIDO</b></p>
 	<p><b>Conexión instrumento:</b> EMS Piezon, con luz  <b>Conexión equipo:</b> KaVo® 1057, 1058*, 1060, 1062, 1063, 1065, 1066, 1078, 1080 (*Excepto 1058 Primus Life) (Serie 1)</p> <p><b>Origen:</b> Italia      <b>Fabricante:</b> Tekne Dental (TKD®)      <b>Garantía:</b> 12 meses</p> <p><b>Ref.:</b> <b>40-72E6221</b>      <b>178<sup>´</sup>00€</b></p>	<p><b>Longitud:</b> 135cm  <b>Color:</b> Gris medio (RAL 7035)  <b>Diámetro:</b> 9mm (STANDARD)</p> <p><b>BAJO PEDIDO</b></p>
 	<p><b>Conexión instrumento:</b> EMS Piezon, con luz  <b>Conexión equipo:</b> KaVo® 1057, 1058*, 1060, 1062, 1063, 1065, 1066, 1078, 1080 (*Excepto 1058 Primus Life) (Serie 1)</p> <p><b>Origen:</b> Italia      <b>Fabricante:</b> Tekne Dental (TKD®)      <b>Garantía:</b> 12 meses</p> <p><b>Ref.:</b> <b>40-72G6222</b>      <b>288<sup>´</sup>00€</b></p>	<p><b>Longitud:</b> 120cm  <b>Color:</b> Gris medio (RAL 7035)  <b>Diámetro:</b> 9mm (STANDARD)  <b>Regulación de spray</b></p> <p><b>BAJO PEDIDO</b></p>
 	<p><b>Conexión instrumento:</b> EMS Piezon, con luz  <b>Conexión equipo:</b> KaVo® 1057, 1058*, 1060, 1062, 1063, 1065, 1066, 1078, 1080 (*Excepto 1058 Primus Life) (Serie 1)</p> <p><b>Origen:</b> Italia      <b>Fabricante:</b> Tekne Dental (TKD®)      <b>Garantía:</b> 12 meses</p> <p><b>Ref.:</b> <b>40-72E6222</b>      <b>288<sup>´</sup>00€</b></p>	<p><b>Longitud:</b> 135cm  <b>Color:</b> Gris medio (RAL 7035)  <b>Diámetro:</b> 9mm (STANDARD)  <b>Regulación de spray</b></p> <p><b>BAJO PEDIDO</b></p>
 	<p><b>Conexión instrumento:</b> EMS Piezon, con luz  <b>Conexión equipo:</b> KaVo® E30S, E30T, E50S y E70S, excepto E50T, E70T y E80T (Serie 2: sin sensor magnético)</p> <p><b>Origen:</b> Italia      <b>Fabricante:</b> Tekne Dental (TKD®)      <b>Garantía:</b> 12 meses</p> <p><b>Ref.:</b> <b>40-72G6223</b>      <b>178<sup>´</sup>00€</b></p>	<p><b>Longitud:</b> 120cm  <b>Color:</b> Gris medio (RAL 7035)  <b>Diámetro:</b> 9mm (STANDARD)</p> <p><b>BAJO PEDIDO</b></p>
 	<p><b>Conexión instrumento:</b> EMS Piezon, con luz  <b>Conexión equipo:</b> KaVo® E30S, E30T, E50S y E70S, excepto E50T, E70T y E80T (Serie 2: sin sensor magnético)</p> <p><b>Origen:</b> Italia      <b>Fabricante:</b> Tekne Dental (TKD®)      <b>Garantía:</b> 12 meses</p> <p><b>Ref.:</b> <b>40-72E6223</b>      <b>168<sup>´</sup>00€</b></p>	<p><b>Longitud:</b> 135cm  <b>Color:</b> Gris medio (RAL 7035)  <b>Diámetro:</b> 9mm (STANDARD)</p> <p><b>BAJO PEDIDO</b></p>
 	<p><b>Conexión instrumento:</b> EMS Piezon, con luz  <b>Conexión equipo:</b> KaVo® E30S, E30T, E50S y E70S, excepto E50T, E70T y E80T (Serie 2: sin sensor magnético)</p> <p><b>Origen:</b> Italia      <b>Fabricante:</b> Tekne Dental (TKD®)      <b>Garantía:</b> 12 meses</p> <p><b>Ref.:</b> <b>40-72G6224</b>      <b>294<sup>´</sup>80€</b></p>	<p><b>Longitud:</b> 120cm  <b>Color:</b> Gris medio (RAL 7035)  <b>Diámetro:</b> 9mm (STANDARD)  <b>Regulación de spray</b></p> <p><b>BAJO PEDIDO</b></p>
 	<p><b>Conexión instrumento:</b> EMS Piezon, con luz  <b>Conexión equipo:</b> KaVo® E30S, E30T, E50S y E70S, excepto E50T, E70T y E80T (Serie 2: sin sensor magnético)</p> <p><b>Origen:</b> Italia      <b>Fabricante:</b> Tekne Dental (TKD®)      <b>Garantía:</b> 12 meses</p> <p><b>Ref.:</b> <b>40-72E6224</b>      <b>294<sup>´</sup>80€</b></p>	<p><b>Longitud:</b> 135cm  <b>Color:</b> Gris medio (RAL 7035)  <b>Diámetro:</b> 9mm (STANDARD)  <b>Regulación de spray</b></p> <p><b>BAJO PEDIDO</b></p>

**Mangueras para Ultrasonidos EMS®: Conector a equipo KaVo®**

**Características**











 	<p><b>Conexión instrumento:</b> EMS Piezon, con luz  <b>Conexión equipo:</b> KaVo® E50T, E70T, E80T y KaVo® 1058 Life + (Serie 3) (Con sensor magnético y con resistencia)</p> <p><b>Origen:</b> Italia      <b>Fabricante:</b> Tekne Dental (TKD®)      <b>Garantía:</b> 12 meses</p> <p><b>Ref.: 40-72G6225</b> <span style="float: right;"><b>238<sup>80</sup>€</b></span></p>	<p><b>Longitud:</b> 120cm  <b>Color:</b> Gris medio (RAL 7035)  <b>Diámetro:</b> 9mm (STANDARD)</p> <p style="text-align: right;"><b>BAJO PEDIDO</b></p>
 	<p><b>Conexión instrumento:</b> EMS Piezon, con luz  <b>Conexión equipo:</b> KaVo® E50T, E70T, E80T y KaVo® 1058 Life + (Serie 3) (Con sensor magnético y con resistencia)</p> <p><b>Origen:</b> Italia      <b>Fabricante:</b> Tekne Dental (TKD®)      <b>Garantía:</b> 12 meses</p> <p><b>Ref.: 40-72E6225</b> <span style="float: right;"><b>243<sup>80</sup>€</b></span></p>	<p><b>Longitud:</b> 135cm  <b>Color:</b> Gris medio (RAL 7035)  <b>Diámetro:</b> 9mm (STANDARD)</p> <p style="text-align: right;"><b>BAJO PEDIDO</b></p>
 	<p><b>Conexión instrumento:</b> EMS Piezon, con luz  <b>Conexión equipo:</b> KaVo® E50T, E70T, E80T y KaVo® 1058 Life + (Serie 3) (Con sensor magnético y con resistencia)</p> <p><b>Origen:</b> Italia      <b>Fabricante:</b> Tekne Dental (TKD®)      <b>Garantía:</b> 12 meses</p> <p><b>Ref.: 40-72G6226</b> <span style="float: right;"><b>345<sup>80</sup>€</b></span></p>	<p><b>Longitud:</b> 120cm  <b>Color:</b> Gris medio (RAL 7035)  <b>Diámetro:</b> 9mm (STANDARD)  <b>Regulación de spray</b></p> <p style="text-align: right;"><b>BAJO PEDIDO</b></p>
 	<p><b>Conexión instrumento:</b> EMS Piezon, con luz  <b>Conexión equipo:</b> KaVo® E50T, E70T, E80T y KaVo® 1058 Life + (Serie 3) (Con sensor magnético y con resistencia)</p> <p><b>Origen:</b> Italia      <b>Fabricante:</b> Tekne Dental (TKD®)      <b>Garantía:</b> 12 meses</p> <p><b>Ref.: 40-72E6226</b> <span style="float: right;"><b>349<sup>80</sup>€</b></span></p>	<p><b>Longitud:</b> 135cm  <b>Color:</b> Gris medio (RAL 7035)  <b>Diámetro:</b> 9mm (STANDARD)  <b>Regulación de spray</b></p> <p style="text-align: right;"><b>BAJO PEDIDO</b></p>

**Mangueras para Ultrasonidos EMS®: Conector a equipo Planmeca®**



**Mangueras para Ultrasonidos EMS®: Conector a equipo Planmeca®**

**Características**

 	<p><b>Conexión instrumento:</b> EMS® Piezon, sin luz  <b>Conexión equipo:</b> Planmeca®</p> <p><b>Origen:</b> Italia      <b>Fabricante:</b> Tekne Dental (TKD®)      <b>Garantía:</b> 12 meses</p> <p><b>Ref.: 40-72K1210</b> (Ref. Planmeca®: J2900263-16) <span style="float: right;"><b>178<sup>00</sup>€</b></span></p>	<p><b>Longitud:</b> 93cm  <b>Color:</b> Gris claro (RAL 9002)  <b>Diámetro:</b> 7mm  <b>Resistencia:</b> 1300 Ohm</p> <p style="text-align: right;"><b>BAJO PEDIDO</b></p>
 	<p><b>Conexión instrumento:</b> EMS® Piezon, sin luz  <b>Conexión equipo:</b> Planmeca®</p> <p><b>Origen:</b> Italia      <b>Fabricante:</b> Tekne Dental (TKD®)      <b>Garantía:</b> 12 meses</p> <p><b>Ref.: 40-72K1200</b> (Ref. Planmeca®: J2900263-16) <span style="float: right;"><b>178<sup>00</sup>€</b></span></p>	<p><b>Longitud:</b> 93cm  <b>Color:</b> Gris claro (RAL 9002)  <b>Diámetro:</b> 9mm  <b>Resistencia:</b> 1300 Ohm</p>
 	<p><b>Conexión instrumento:</b> EMS® Piezon, sin luz  <b>Conexión equipo:</b> Planmeca®</p> <p><b>Origen:</b> Italia      <b>Fabricante:</b> Tekne Dental (TKD®)      <b>Garantía:</b> 12 meses</p> <p><b>Ref.: 40-72D1210</b> (Ref. Planmeca®: J2900263-16) <span style="float: right;"><b>194<sup>80</sup>€</b></span></p>	<p><b>Longitud:</b> 153cm  <b>Color:</b> Gris claro (RAL 9002)  <b>Diámetro:</b> 7mm  <b>Resistencia:</b> 1300 Ohm</p> <p style="text-align: right;"><b>BAJO PEDIDO</b></p>
 	<p><b>Conexión instrumento:</b> EMS® Piezon, sin luz  <b>Conexión equipo:</b> Planmeca®</p> <p><b>Origen:</b> Italia      <b>Fabricante:</b> Tekne Dental (TKD®)      <b>Garantía:</b> 12 meses</p> <p><b>Ref.: 40-72D1200</b> (Ref. Planmeca®: J2900263-16) <span style="float: right;"><b>194<sup>80</sup>€</b></span></p>	<p><b>Longitud:</b> 153cm  <b>Color:</b> Gris claro (RAL 9002)  <b>Diámetro:</b> 9mm  <b>Resistencia:</b> 1300 Ohm</p> <p style="text-align: right;"><b>BAJO PEDIDO</b></p>
 	<p><b>Conexión instrumento:</b> EMS® PiezonLED  <b>Conexión equipo:</b> Planmeca®</p> <p><b>Origen:</b> Italia      <b>Fabricante:</b> Tekne Dental (TKD®)      <b>Garantía:</b> 12 meses</p> <p><b>Ref.: 40-72K1220</b> (Ref. Planmeca®: J10026732-16) <span style="float: right;"><b>218<sup>80</sup>€</b></span></p>	<p><b>Longitud:</b> 91cm  <b>Color:</b> Gris claro (RAL 9002)  <b>Diámetro:</b> 7mm</p> <p style="text-align: right;"><b>BAJO PEDIDO</b></p>

**Mangueras para Ultrasonidos EMS®: Conector a equipo Planmeca®**

**Características**

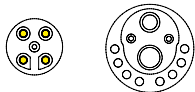

**Conexión instrumento:** EMS® PiezoLED  
**Conexión equipo:** Planmeca®  
**Origen:** Italia      **Fabricante:** Tekne Dental (TKD®)      **Garantía:** 12 meses

**Longitud:** 91cm  
**Color:** Gris claro (RAL 9002)  
**Diámetro:** 9mm

**Ref.:** 40-72K1230 (Ref. Planmeca®: J10026732-16)

218<sup>80</sup>€

BAJO PEDIDO

## Mangueras para ultrasonidos KaVo®

Conexión a equipo: **Abierta / Open end**    Cefla®    **KaVo®**    Planmeca®    Sirona®

**Mangueras para Ultrasonidos KaVo®: Conexión Abierta / Open End**

RUMAR

**Mangueras para Ultrasonidos KaVo®: Conexión Abierta / Open End**

**Características**



**Conexión instrumento:** KaVo® PiezoLED, con luz  
**Conexión equipo:** Abierta  
**Origen:** Italia      **Fabricante:** Tekne Dental (TKD®)      **Garantía:** 12 meses

**Longitud:** 160cm  
**Color:** Gris medio (RAL 7035)  
**Diámetro:** 9mm (STANDARD)  
**Regulación de spray**

**Ref.:** 40-71A6500

208<sup>00</sup>€

**Mangueras para Ultrasonidos KaVo®: Conector a equipo KaVo®**

RUMAR

**Mangueras para Ultrasonidos KaVo®: Conector a equipo KaVo®**

**Características**

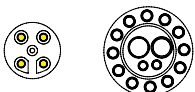

**Conexión instrumento:** KaVo® PiezoSOFT y PiezoLED, con luz  
**Conexión equipo:** KaVo® E30S, E30T, E50S y E70S, excepto E50T, E70T y E80T (Serie 2: sin sensor magnético)  
**Origen:** Italia      **Fabricante:** Tekne Dental (TKD®)      **Garantía:** 12 meses

**Longitud:** 120cm  
**Color:** Gris medio (RAL 7035)

**Ref.:** 40-72G6600

188<sup>00</sup>€

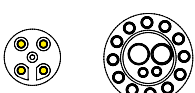

**Conexión instrumento:** KaVo® PiezoSOFT y PiezoLED, con luz  
**Conexión equipo:** KaVo® E30S, E30T, E50S y E70S, excepto E50T, E70T y E80T (Serie 2: sin sensor magnético)  
**Origen:** Italia      **Fabricante:** Tekne Dental (TKD®)      **Garantía:** 12 meses

**Longitud:** 135cm  
**Color:** Gris medio (RAL 7035)

**Ref.:** 40-72E6600

188<sup>00</sup>€

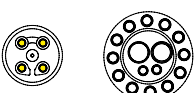

**Conexión instrumento:** KaVo® PiezoSOFT y PiezoLED, con luz  
**Conexión equipo:** KaVo® E30S, E30T, E50S y E70S, excepto E50T, E70T y E80T (Serie 2: sin sensor magnético)  
**Origen:** Italia      **Fabricante:** Tekne Dental (TKD®)      **Garantía:** 12 meses

**Longitud:** 120cm  
**Color:** Gris medio (RAL 7035)  
**Regulación de spray**

**Ref.:** 40-72G6500

298<sup>00</sup>€

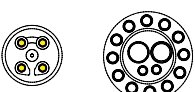

**Conexión instrumento:** KaVo® PiezoSOFT y PiezoLED, con luz  
**Conexión equipo:** KaVo® E30S, E30T, E50S y E70S, excepto E50T, E70T y E80T (Serie 2: sin sensor magnético)  
**Origen:** Italia      **Fabricante:** Tekne Dental (TKD®)      **Garantía:** 12 meses

**Longitud:** 135cm  
**Color:** Gris medio (RAL 7035)  
**Regulación de spray**

**Ref.:** 40-72E6500

298<sup>00</sup>€

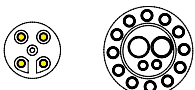

**Conexión instrumento:** KaVo® PiezoSOFT y PiezoLED, con luz  
**Conexión equipo:** KaVo® E50T, E70T, E80T y KaVo® 1058 Life + (Serie 3) (Con sensor magnético y con resistencia)  
**Origen:** Italia      **Fabricante:** Tekne Dental (TKD®)      **Garantía:** 12 meses

**Longitud:** 120cm  
**Color:** Gris medio (RAL 7035)

**Ref.:** 40-72G6601

238<sup>80</sup>€

BAJO PEDIDO

**Mangueras para Ultrasonidos KaVo®: Conector a equipo KaVo®**

**Características**

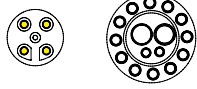

**Conexión instrumento:** KaVo® PiezoSOFT y PiezoLED, con luz  
**Conexión equipo:** KaVo® E50T, E70T, E80T y KaVo® 1058 Life + (Serie 3) (Con sensor magnético y con resistencia)

**Longitud:** 135cm  
**Color:** Gris medio (RAL 7035)

**Origen:** Italia **Fabricante:** Tekne Dental (TKD®) **Garantía:** 12 meses

**Ref.:** 40-72E6601

243<sup>80</sup>€

BAJO PEDIDO

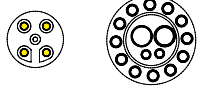

**Conexión instrumento:** KaVo® PiezoSOFT y PiezoLED, con luz  
**Conexión equipo:** KaVo® E50T, E70T, E80T y KaVo® 1058 Life + (Serie 3) (Con sensor magnético y con resistencia)

**Longitud:** 120cm  
**Color:** Gris medio (RAL 7035)  
**Regulación de spray**

**Origen:** Italia **Fabricante:** Tekne Dental (TKD®) **Garantía:** 12 meses

**Ref.:** 40-72G6501

345<sup>80</sup>€

BAJO PEDIDO

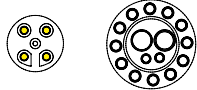

**Conexión instrumento:** KaVo® PiezoSOFT y PiezoLED, con luz  
**Conexión equipo:** KaVo® E50T, E70T, E80T y KaVo® 1058 Life + (Serie 3) (Con sensor magnético y con resistencia)

**Longitud:** 135cm  
**Color:** Gris medio (RAL 7035)  
**Regulación de spray**

**Origen:** Italia **Fabricante:** Tekne Dental (TKD®) **Garantía:** 12 meses

**Ref.:** 40-72E6501

349<sup>80</sup>€

BAJO PEDIDO

## Mangueras para Ultrasonidos MECTRON®

Conexión a equipo: **Abierta / Open end** > Cefla® > KaVo® > Planmeca® > Sirona®

### Mangueras para Ultrasonidos MECTRON®: Conexión Abierta / Open End

RUMAR

**Mangueras para Ultrasonidos MECTRON®: Conexión Abierta / Open End**

**Características**



**Conexión instrumento:** Mectron y Bien Air® Powercare, sin luz  
**Conexión equipo:** Abierta

**Longitud:** 200cm  
**Color:** Gris oscuro (RAL 7038)  
**Diámetro:** 9mm (STANDARD)

**Origen:** Italia **Fabricante:** Tekne Dental (TKD®) **Garantía:** 12 meses

**Ref.:** 40-71N2300

108<sup>00</sup>€

## Mangueras Ultrasonidos TKD®

Conexión a equipo: **Abierta / Open end** > Cefla® > KaVo® > Planmeca® > Sirona®

### Mangueras Ultrasonidos TKD®: Conexión Abierta / Open End

RUMAR

**Mangueras Ultrasonidos TKD®: Conexión Abierta / Open End**

**Características**



**Conexión instrumento:** TKD® (conexión TKD), sin luz  
**Conexión equipo:** Abierta

**Longitud:** 160cm  
**Color:** Gris oscuro (RAL 7038)

**Origen:** Italia **Fabricante:** Tekne Dental (TKD®) **Garantía:** 12 meses

**Ref.:** 40-71A2400

64<sup>80</sup>€

## MANGUERAS PARA MICROMOTORES

### Mangueras para micromotores **Bien Air®**

Conexión a equipo: **Abierta/Open end** > Cefla® > KaVo® > Planmeca® > Sirona®

### Mangueras para micromotores **Cefla®**

Conexión a equipo: **Abierta/Open end** > Cefla® > KaVo® > Planmeca® > Sirona®

### Mangueras para micromotores **Chirana®**

Conexión a equipo: **Abierta/Open end** > Cefla® > KaVo® > Planmeca® > Sirona®

### Mangueras para micromotores **KaVo®**

Conexión a equipo: **Abierta/Open end** > Cefla® > KaVo® > Planmeca® > Sirona®

### Mangueras para micromotores **NSK®**

Conexión a equipo: **Abierta/Open end** > Cefla® > KaVo® > Planmeca® > Sirona®

### Mangueras para micromotores **Sirona®**





Conexión a equipo: **Abierta/Open end** > Cefla® > KaVo® > Planmeca® > Sirona®

## Mangueras para Micromotores **Bien Air®**

Conexión a equipo: **Abierta/Open end** > Cefla® > KaVo® > Planmeca® > Sirona®

### Mangueras para Micromotores Bien Air®: Conexión Abierta / Open End

RUMAR 

	Mangueras para Micromotores Bien Air®: Conexión Abierta / Open End	Características
	<p><b>Conexión instrumento:</b> MC2, Isolite/LED, ISO300 con luz <b>Conexión equipo:</b> Abierta</p> <p><b>Origen:</b> Italia      <b>Fabricante:</b> Tekne Dental (TKD®)      <b>Garantía:</b> 12 meses</p> <p><b>Ref.:</b> <b>40-51B1006**</b>      <b>106<sup>80</sup>€</b></p>	<p><b>Longitud:</b> 200cm <b>Color:</b> Gris claro (RAL 9002) ** Adquiriendo casquillo Ref: 40-010 se transforma en versión s/luz = "2 EN 1"</p> <p><b>BAJO PEDIDO</b></p>
	<p><b>Conexión instrumento:</b> MC2, Isolite/LED, ISO300 con luz <b>Conexión equipo:</b> Abierta</p> <p><b>Origen:</b> Italia      <b>Fabricante:</b> Tekne Dental (TKD®)      <b>Garantía:</b> 12 meses</p> <p><b>Ref.:</b> <b>40-51A1006**</b>      <b>98<sup>00</sup>€</b></p>	<p><b>Longitud:</b> 160cm <b>Color:</b> Gris claro (RAL 9002) ** Adquiriendo casquillo Ref: 40-010 se transforma en versión s/luz = "2 EN 1"</p>
	<p><b>Conexión instrumento:</b> MC2, Isolite/LED, ISO300 con luz <b>Conexión equipo:</b> Abierta</p> <p><b>Origen:</b> Italia      <b>Fabricante:</b> Tekne Dental (TKD®)      <b>Garantía:</b> 12 meses</p> <p><b>Ref.:</b> <b>40-51B2006**</b>      <b>106<sup>80</sup>€</b></p>	<p><b>Longitud:</b> 200cm <b>Color:</b> Gris oscuro (RAL 7038) ** Adquiriendo casquillo Ref: 40-010 se transforma en versión s/luz = "2 EN 1"</p> <p><b>BAJO PEDIDO</b></p>
	<p><b>Conexión instrumento:</b> MC2, Isolite/LED, ISO300 con luz <b>Conexión equipo:</b> Abierta</p> <p><b>Origen:</b> Italia      <b>Fabricante:</b> Tekne Dental (TKD®)      <b>Garantía:</b> 12 meses</p> <p><b>Ref.:</b> <b>40-51A2006**</b>      <b>98<sup>00</sup>€</b></p>	<p><b>Longitud:</b> 160cm <b>Color:</b> Gris oscuro (RAL 7038) ** Adquiriendo casquillo Ref: 40-010 se transforma en versión s/luz = "2 EN 1"</p>
	<p><b>Conexión instrumento:</b> MC2, Isolite/LED, ISO300 con luz <b>Conexión equipo:</b> Abierta</p> <p><b>Origen:</b> Italia      <b>Fabricante:</b> Tekne Dental (TKD®)      <b>Garantía:</b> 12 meses</p> <p><b>Ref.:</b> <b>40-51A1001**</b>      <b>138<sup>80</sup>€</b></p>	<p><b>Longitud:</b> 160cm <b>Color:</b> Gris claro (RAL 9002) <b>Terminal giratorio:</b> 540° ** Adquiriendo casquillo Ref: 40-010 se transforma en versión s/luz = "2 EN 1"</p>

## Mangueras para Micromotores Bien Air®: Conexión Abierta / Open End

## Características

	<p><b>Conexión instrumento:</b> MC2, Isolite/LED, ISO300 con luz <b>Conexión equipo:</b> Abierta</p> <p><b>Origen:</b> Italia      <b>Fabricante:</b> Tekne Dental (TKD®)      <b>Garantía:</b> 12 meses</p> <p><b>Ref.:</b> <b>40-51A2001**</b></p>	<p><b>Longitud:</b> 160cm <b>Color:</b> Gris oscuro (RAL 7038) <b>Terminal giratorio:</b> 540° ** Adquiriendo casquillo Ref. 40-010 se transforma en versión s/luz = "2 EN 1"</p> <p><b>138<sup>80</sup>€</b></p>
	<p><b>Conexión instrumento:</b> MC2 IR, sin luz <b>Conexión equipo:</b> Abierta</p> <p><b>Origen:</b> Italia      <b>Fabricante:</b> Tekne Dental (TKD®)      <b>Garantía:</b> 12 meses</p> <p><b>Ref.:</b> <b>40-51B1002</b></p>	<p><b>Longitud:</b> 200cm <b>Color:</b> Gris claro (RAL 9002)</p> <p><b>102<sup>80</sup>€</b></p> <p><b>BAJO PEDIDO</b></p>
	<p><b>Conexión instrumento:</b> MC2 IR, sin luz <b>Conexión equipo:</b> Abierta</p> <p><b>Origen:</b> Italia      <b>Fabricante:</b> Tekne Dental (TKD®)      <b>Garantía:</b> 12 meses</p> <p><b>Ref.:</b> <b>40-51A1002</b></p>	<p><b>Longitud:</b> 160cm <b>Color:</b> Gris claro (RAL 9002)</p> <p><b>93<sup>80</sup>€</b></p>
	<p><b>Conexión instrumento:</b> MC2 IR, sin luz <b>Conexión equipo:</b> Abierta</p> <p><b>Origen:</b> Italia      <b>Fabricante:</b> Tekne Dental (TKD®)      <b>Garantía:</b> 12 meses</p> <p><b>Ref.:</b> <b>40-51A2002</b></p>	<p><b>Longitud:</b> 160cm <b>Color:</b> Gris oscuro (RAL 7038)</p> <p><b>93<sup>80</sup>€</b></p>
	<p><b>Conexión instrumento:</b> MC3/LK/LED + turbina, Polivalente, con y sin luz <b>Conexión equipo:</b> Abierta</p> <p><b>Origen:</b> Italia      <b>Fabricante:</b> Tekne Dental (TKD®)      <b>Garantía:</b> 12 meses</p> <p><b>Ref.:</b> <b>40-51B1003</b></p>	<p><b>Longitud:</b> 200cm <b>Color:</b> Gris claro (RAL 9002)</p> <p><b>103<sup>80</sup>€</b></p> <p><b>BAJO PEDIDO</b></p>
	<p><b>Conexión instrumento:</b> MC3/LK/LED + turbina, Polivalente, con y sin luz <b>Conexión equipo:</b> Abierta</p> <p><b>Origen:</b> Italia      <b>Fabricante:</b> Tekne Dental (TKD®)      <b>Garantía:</b> 12 meses</p> <p><b>Ref.:</b> <b>40-51A1003</b></p>	<p><b>Longitud:</b> 160cm <b>Color:</b> Gris claro (RAL 9002)</p> <p><b>94<sup>80</sup>€</b></p>
	<p><b>Conexión instrumento:</b> MC3/LK/LED + turbina, Polivalente, con y sin luz <b>Conexión equipo:</b> Abierta</p> <p><b>Origen:</b> Italia      <b>Fabricante:</b> Tekne Dental (TKD®)      <b>Garantía:</b> 12 meses</p> <p><b>Ref.:</b> <b>40-51B2003</b></p>	<p><b>Longitud:</b> 200cm <b>Color:</b> Gris oscuro (RAL 7038)</p> <p><b>103<sup>80</sup>€</b></p>
	<p><b>Conexión instrumento:</b> MC3/LK/LED + turbina, Polivalente, con y sin luz <b>Conexión equipo:</b> Abierta</p> <p><b>Origen:</b> Italia      <b>Fabricante:</b> Tekne Dental (TKD®)      <b>Garantía:</b> 12 meses</p> <p><b>Ref.:</b> <b>40-51A2003</b></p>	<p><b>Longitud:</b> 160cm <b>Color:</b> Gris oscuro (RAL 7038)</p> <p><b>94<sup>80</sup>€</b></p>
	<p><b>Conexión instrumento:</b> MC3/LK/LED, con y sin luz <b>Conexión equipo:</b> Abierta</p> <p><b>Origen:</b> Italia      <b>Fabricante:</b> Tekne Dental (TKD®)      <b>Garantía:</b> 12 meses</p> <p><b>Ref.:</b> <b>40-51A2005</b></p>	<p><b>Longitud:</b> 160cm <b>Color:</b> Gris oscuro (RAL 7038)</p> <p><b>87<sup>80</sup>€</b></p>
	<p><b>Conexión instrumento:</b> MC3/LK/LED, con y sin luz + TKD® micromotor DEFINITIVE con y sin luz <b>Conexión equipo:</b> Abierta</p> <p><b>Origen:</b> Italia      <b>Fabricante:</b> Tekne Dental (TKD®)      <b>Garantía:</b> 12 meses</p> <p><b>Ref.:</b> <b>40-51A2009</b></p>	<p><b>Longitud:</b> 160cm <b>Color:</b> Gris oscuro (RAL 7038) <b>Terminal giratorio</b></p> <p><b>118<sup>00</sup>€</b></p> <p><b>BAJO PEDIDO</b></p>

**Mangueras para Micromotores Bien Air®: Conexión Abierta / Open End**

**Características**

	<p>Conexión instrumento: MC3/LK/LED con y sin luz                  Conexión equipo: Abierta</p>	<p>Longitud: 160cm                  Color: Gris oscuro (RAL 7038)                  Regulación de spray</p>
	<p>Origen: Italia      Fabricante: Tekne Dental (TKD®)      Garantía: 12 meses</p>	
	<p>Ref.: <b>40-51A2004</b></p>	<p><b>198<sup>00</sup>€</b></p>
		<p>BAJO PEDIDO</p>
	<p>Conexión instrumento: MCX LED                  Conexión equipo: Abierta</p>	<p>Longitud: 160cm                  Color: Gris claro (RAL 9002)</p>
	<p>Origen: Italia      Fabricante: Tekne Dental (TKD®)      Garantía: 12 meses</p>	
	<p>Ref.: <b>40-51A1007</b></p>	<p><b>148<sup>00</sup>€</b></p>
	<p>Conexión instrumento: MCX LED                  Conexión equipo: Abierta</p>	<p>Longitud: 160cm                  Color: Gris oscuro (RAL 7038)</p>
	<p>Origen: Italia      Fabricante: Tekne Dental (TKD®)      Garantía: 12 meses</p>	
	<p>Ref.: <b>40-51A2007</b></p>	<p><b>148<sup>00</sup>€</b></p>
	<p>Conexión instrumento: MCX LED                  Conexión equipo: Abierta</p>	<p>Longitud: 160cm                  Color: Gris claro (RAL 9002)                  Terminal giratorio: 540°</p>
	<p>Origen: Italia      Fabricante: Tekne Dental (TKD®)      Garantía: 12 meses</p>	
	<p>Ref.: <b>40-51A1008</b></p>	<p><b>168<sup>00</sup>€</b></p>
		<p>BAJO PEDIDO</p>
	<p>Conexión instrumento: MCX LED                  Conexión equipo: Abierta</p>	<p>Longitud: 160cm                  Color: Gris oscuro (RAL 7038)                  Terminal giratorio: 540°</p>
	<p>Origen: Italia      Fabricante: Tekne Dental (TKD®)      Garantía: 12 meses</p>	
	<p>Ref.: <b>40-51A2008</b></p>	<p><b>168<sup>00</sup>€</b></p>
		<p>BAJO PEDIDO</p>

**Mangueras para Micromotores Bien Air®: Conector a equipo Cefla® (desde 2006) Anthos, Stern Weber, Castellini**



**Mangueras para Micromotores Bien Air®: Conector a equipo Cefla® (desde 2006)**

**Características**

	<p>Conexión instrumento: Bien Air® MC2 IR                  Conexión equipo Cefla® (desde 2006):                  Anthos®: A3, A5, A6, A7, A9, L6, L9, R7; Stern Weber®: S200, S220TR S250, S280TRC, S300, 320TR, S320TR, S380TRC;                  Castellini®: SKEMA 5, SKEMA 6, SKEMA 8, PUMA ELI</p>	<p>Longitud: 135cm                  Color: Gris oscuro (RAL 7038)</p>
	<p>Origen: Italia      Fabricante: Tekne Dental (TKD®)      Garantía: 12 meses</p>	
	<p>Ref.: <b>40-52E2002</b></p>	<p><b>149<sup>80</sup>€</b></p>
	<p>Conexión instrumento: Bien Air® MC2 IR                  Conexión equipo Cefla® (desde 2006):                  Anthos®: A3, A5, A6, A7, A9, L6, L9, R7; Stern Weber®: S200, S220TR S250, S280TRC, S300, 320TR, S320TR, S380TRC;                  Castellini®: SKEMA 5, SKEMA 6, SKEMA 8, PUMA ELI</p>	<p>Longitud: 120cm                  Color: Gris oscuro (RAL 7038)</p>
	<p>Origen: Italia      Fabricante: Tekne Dental (TKD®)      Garantía: 12 meses</p>	
	<p>Ref.: <b>40-52G2002</b></p>	<p><b>149<sup>80</sup>€</b></p>
	<p>Conexión instrumento: Bien Air® MC2 Isolite/LED                  Conexión equipo Cefla® (desde 2006):                  Anthos®: A3, A5, A6, A7, A9, L6, L9, R7; Stern Weber®: S200, S220TR S250, S280TRC, S300, 320TR, S320TR, S380TRC;                  Castellini®: SKEMA 5, SKEMA 6, SKEMA 8, PUMA ELI</p>	<p>Longitud: 135cm                  Color: Gris oscuro (RAL 7038)</p>
	<p>Origen: Italia      Fabricante: Tekne Dental (TKD®)      Garantía: 12 meses</p>	
	<p>Ref.: <b>40-52E2006</b></p>	<p><b>174<sup>80</sup>€</b></p>
		<p>BAJO PEDIDO</p>
	<p>Conexión instrumento: Bien Air® MC2 Isolite/LED                  Conexión equipo Cefla® (desde 2006):                  Anthos®: A3, A5, A6, A7, A9, L6, L9, R7; Stern Weber®: S200, S220TR S250, S280TRC, S300, 320TR, S320TR, S380TRC;                  Castellini®: SKEMA 5, SKEMA 6, SKEMA 8, PUMA ELI</p>	<p>Longitud: 120cm                  Color: Gris oscuro (RAL 7038)</p>
	<p>Origen: Italia      Fabricante: Tekne Dental (TKD®)      Garantía: 12 meses</p>	
	<p>Ref.: <b>40-52G2006</b></p>	<p><b>185<sup>80</sup>€</b></p>





















Mangueras para Micromotores Bien Air®: Conector a equipo Cefla® (desde 2006)

Características

	<p>Conexión instrumento: Bien Air® MC2 Isolite/LED  <b>Conexión equipo Cefla® (desde 2006):</b>                      Anthos®: A3, A5, A6, A7, A9, L6, L9, R7; <b>Stern Weber®:</b> S200, S220TR S250, S280TRC, S300, 320TR, S320TR, S380TRC;                      Castellini®: SKEMA 5, SKEMA 6, SKEMA 8, PUMA ELI                      Origen: Italia      Fabricante: Tekne Dental (TKD®)      Garantía: 12 meses</p>	<p>Longitud: 135cm                      Color: Gris oscuro (RAL 7038)                      Terminal giratorio</p>
<p>Ref.: <b>40-52E2010</b></p>	<p><b>216<sup>80</sup>€</b></p>	<p>BAJO PEDIDO</p>
	<p>Conexión instrumento: Bien Air® MC2 Isolite/LED  <b>Conexión equipo Cefla® (desde 2006):</b>                      Anthos®: A3, A5, A6, A7, A9, L6, L9, R7; <b>Stern Weber®:</b> S200, S220TR S250, S280TRC, S300, 320TR, S320TR, S380TRC;                      Castellini®: SKEMA 5, SKEMA 6, SKEMA 8, PUMA ELI                      Origen: Italia      Fabricante: Tekne Dental (TKD®)      Garantía: 12 meses</p>	<p>Longitud: 120cm                      Color: Gris oscuro (RAL 7038)                      Terminal giratorio</p>
<p>Ref.: <b>40-52G2010</b></p>	<p><b>211<sup>80</sup>€</b></p>	<p>BAJO PEDIDO</p>
	<p>Conexión instrumento: Bien Air® MC3, MC3LK, MC3 LED, con y sin luz.  <b>Conexión equipo Cefla® (desde 2006):</b>                      Anthos®: A3, A5, A6, A7, A9, L6, L9, R7; <b>Stern Weber®:</b> S200, S220TR S250, S280TRC, S300, 320TR, S320TR, S380TRC;                      Castellini®: SKEMA 5, SKEMA 6, SKEMA 8, PUMA ELI                      Origen: Italia      Fabricante: Tekne Dental (TKD®)      Garantía: 12 meses</p>	<p>Longitud: 135cm                      Color: Gris oscuro (RAL 7038)</p>
<p>Ref.: <b>40-52E2005</b></p>	<p><b>164<sup>80</sup>€</b></p>	
	<p>Conexión instrumento: Bien Air® MC3, MC3LK, MC3 LED, con y sin luz.  <b>Conexión equipo Cefla® (desde 2006):</b>                      Anthos®: A3, A5, A6, A7, A9, L6, L9, R7; <b>Stern Weber®:</b> S200, S220TR S250, S280TRC, S300, 320TR, S320TR, S380TRC;                      Castellini®: SKEMA 5, SKEMA 6, SKEMA 8, PUMA ELI                      Origen: Italia      Fabricante: Tekne Dental (TKD®)      Garantía: 12 meses</p>	<p>Longitud: 120cm                      Color: Gris oscuro (RAL 7038)</p>
<p>Ref.: <b>40-52G2005</b></p>	<p><b>178<sup>00</sup>€</b></p>	
	<p>Conexión instrumento: Bien Air® MC3, MC3LK, MC3 LED, con y sin luz.  <b>Conexión equipo Cefla® (desde 2006):</b>                      Anthos®: A3, A5, A6, A7, A9, L6, L9, R7; <b>Stern Weber®:</b> S200, S220TR S250, S280TRC, S300, 320TR, S320TR, S380TRC;                      Castellini®: SKEMA 5, SKEMA 6, SKEMA 8, PUMA ELI                      Origen: Italia      Fabricante: Tekne Dental (TKD®)      Garantía: 12 meses</p>	<p>Longitud: 135cm                      Color: Gris oscuro (RAL 7038)                      Terminal giratorio</p>
<p>Ref.: <b>40-52E2004</b></p>	<p><b>184<sup>80</sup>€</b></p>	
	<p>Conexión instrumento: Bien Air® MC3, MC3LK, MC3 LED, con y sin luz.  <b>Conexión equipo Cefla® (desde 2006):</b>                      Anthos®: A3, A5, A6, A7, A9, L6, L9, R7; <b>Stern Weber®:</b> S200, S220TR S250, S280TRC, S300, 320TR, S320TR, S380TRC;                      Castellini®: SKEMA 5, SKEMA 6, SKEMA 8, PUMA ELI                      Origen: Italia      Fabricante: Tekne Dental (TKD®)      Garantía: 12 meses</p>	<p>Longitud: 120cm                      Color: Gris oscuro (RAL 7038)                      Terminal giratorio</p>
<p>Ref.: <b>40-52G2004</b></p>	<p><b>196<sup>80</sup>€</b></p>	
	<p>Conexión instrumento: Bien Air® MC3/LK/LED + turbina, polivalente con y sin luz  <b>Conexión equipo Cefla® (desde 2006):</b>                      Anthos®: A3, A5, A6, A7, A9, L6, L9, R7; <b>Stern Weber®:</b> S200, S220TR S250, S280TRC, S300, 320TR, S320TR, S380TRC;                      Castellini®: SKEMA 5, SKEMA 6, SKEMA 8, PUMA ELI                      Origen: Italia      Fabricante: Tekne Dental (TKD®)      Garantía: 12 meses</p>	<p>Longitud: 135cm                      Color: Gris oscuro (RAL 7038)</p>
<p>Ref.: <b>40-52E2003</b></p>	<p><b>184<sup>80</sup>€</b></p>	<p>BAJO PEDIDO</p>
	<p>Conexión instrumento: Bien Air® MC3/LK/LED + turbina, polivalente con y sin luz  <b>Conexión equipo Cefla® (desde 2006):</b>                      Anthos®: A3, A5, A6, A7, A9, L6, L9, R7; <b>Stern Weber®:</b> S200, S220TR S250, S280TRC, S300, 320TR, S320TR, S380TRC;                      Castellini®: SKEMA 5, SKEMA 6, SKEMA 8, PUMA ELI                      Origen: Italia      Fabricante: Tekne Dental (TKD®)      Garantía: 12 meses</p>	<p>Longitud: 120cm                      Color: Gris oscuro (RAL 7038)</p>
<p>Ref.: <b>40-52G2003</b></p>	<p><b>196<sup>80</sup>€</b></p>	
	<p>Conexión instrumento: MCX LED  <b>Conexión equipo Cefla® (desde 2006):</b>                      Anthos®: A3, A5, A6, A7, A9, L6, L9, R7; <b>Stern Weber®:</b> S200, S220TR S250, S280TRC, S300, 320TR, S320TR, S380TRC;                      Castellini®: SKEMA 5, SKEMA 6, SKEMA 8, PUMA ELI                      Origen: Italia      Fabricante: Tekne Dental (TKD®)      Garantía: 12 meses</p>	<p>Longitud: 135cm                      Color: Gris oscuro (RAL 7038)</p>
<p>Ref.: <b>40-52E2007</b></p>	<p><b>245<sup>80</sup>€</b></p>	<p>BAJO PEDIDO</p>
	<p>Conexión instrumento: MCX LED  <b>Conexión equipo Cefla® (desde 2006):</b>                      Anthos®: A3, A5, A6, A7, A9, L6, L9, R7; <b>Stern Weber®:</b> S200, S220TR S250, S280TRC, S300, 320TR, S320TR, S380TRC;                      Castellini®: SKEMA 5, SKEMA 6, SKEMA 8, PUMA ELI                      Origen: Italia      Fabricante: Tekne Dental (TKD®)      Garantía: 12 meses</p>	<p>Longitud: 120cm                      Color: Gris oscuro (RAL 7038)</p>
<p>Ref.: <b>40-52G2007</b></p>	<p><b>239<sup>80</sup>€</b></p>	<p>BAJO PEDIDO</p>



Mangueras para Micromotores Bien Air®: Conector a equipo KaVo®

Características

 	<p>Conexión instrumento: MC2 IR, sin luz Conexión equipo: KaVo® 1057 y 1060</p> <p>Origen: Italia      Fabricante: Tekne Dental (TKD®)      Garantía: 12 meses</p> <p><b>Ref.: 40-52G6002</b> <span style="float: right;"><b>168<sup>00</sup>€</b></span></p>	<p>Longitud: 120cm Color: Gris medio (RAL 7035)</p> <p style="text-align: right;"><b>BAJO PEDIDO</b></p>
 	<p>Conexión instrumento: MC2 IR, sin luz Conexión equipo: KaVo® 1057 y 1060</p> <p>Origen: Italia      Fabricante: Tekne Dental (TKD®)      Garantía: 12 meses</p> <p><b>Ref.: 40-52E6002</b> <span style="float: right;"><b>173<sup>80</sup>€</b></span></p>	<p>Longitud: 135cm Color: Gris medio (RAL 7035)</p> <p style="text-align: right;"><b>BAJO PEDIDO</b></p>
 	<p>Conexión instrumento: MC2 IR, sin luz Conexión equipo: KaVo® 1057, 1058*, 1060, 1062, 1063, 1065, 1066, 1078, 1080 (*Excepto 1058 Primus Life) (Serie 1)</p> <p>Origen: Italia      Fabricante: Tekne Dental (TKD®)      Garantía: 12 meses</p> <p><b>Ref.: 40-52G6012</b> <span style="float: right;"><b>168<sup>00</sup>€</b></span></p>	<p>Longitud: 120cm Color: Gris medio (RAL 7035)</p> <p style="text-align: right;"><b>BAJO PEDIDO</b></p>
 	<p>Conexión instrumento: MC2 IR, sin luz Conexión equipo: KaVo® 1057, 1058*, 1060, 1062, 1063, 1065, 1066, 1078, 1080 (*Excepto 1058 Primus Life) (Serie 1)</p> <p>Origen: Italia      Fabricante: Tekne Dental (TKD®)      Garantía: 12 meses</p> <p><b>Ref.: 40-52E6012</b> <span style="float: right;"><b>173<sup>80</sup>€</b></span></p>	<p>Longitud: 135cm Color: Gris medio (RAL 7035)</p> <p style="text-align: right;"><b>BAJO PEDIDO</b></p>
 	<p>Conexión instrumento: MC2 IR, sin luz Conexión equipo: KaVo® E30S, E30T, E50S, Y E70S, excepto: E50T, E70T y E80T (Serie 2: sin sensor magnético)</p> <p>Origen: Italia      Fabricante: Tekne Dental (TKD®)      Garantía: 12 meses</p> <p><b>Ref.: 40-52G6022</b> <span style="float: right;"><b>165<sup>80</sup>€</b></span></p>	<p>Longitud: 120cm Color: Gris medio (RAL 7035)</p> <p style="text-align: right;"><b>BAJO PEDIDO</b></p>
 	<p>Conexión instrumento: MC2 IR, sin luz Conexión equipo: KaVo® E30S, E30T, E50S, Y E70S, excepto: E50T, E70T y E80T (Serie 2: sin sensor magnético)</p> <p>Origen: Italia      Fabricante: Tekne Dental (TKD®)      Garantía: 12 meses</p> <p><b>Ref.: 40-52E6022</b> <span style="float: right;"><b>171<sup>80</sup>€</b></span></p>	<p>Longitud: 135cm Color: Gris medio (RAL 7035)</p> <p style="text-align: right;"><b>BAJO PEDIDO</b></p>
 	<p>Conexión instrumento: MC2, Isolite/LED, ISO300 con luz Conexión equipo: KaVo® 1057 y 1060</p> <p>Origen: Italia      Fabricante: Tekne Dental (TKD®)      Garantía: 12 meses</p> <p><b>Ref.: 40-52G6006</b> <span style="float: right;"><b>182<sup>80</sup>€</b></span></p>	<p>Longitud: 120cm Color: Gris medio (RAL 7035)</p> <p style="text-align: right;"><b>BAJO PEDIDO</b></p>
 	<p>Conexión instrumento: MC2, Isolite/LED, ISO300 con luz Conexión equipo: KaVo® 1057 y 1060</p> <p>Origen: Italia      Fabricante: Tekne Dental (TKD®)      Garantía: 12 meses</p> <p><b>Ref.: 40-52E6006</b> <span style="float: right;"><b>188<sup>00</sup>€</b></span></p>	<p>Longitud: 135cm Color: Gris medio (RAL 7035)</p> <p style="text-align: right;"><b>BAJO PEDIDO</b></p>
 	<p>Conexión instrumento: MC2, Isolite/LED, ISO300 con luz Conexión equipo: KaVo® 1057 y 1060</p> <p>Origen: Italia      Fabricante: Tekne Dental (TKD®)      Garantía: 12 meses</p> <p><b>Ref.: 40-52G6016</b> <span style="float: right;"><b>210<sup>80</sup>€</b></span></p>	<p>Longitud: 120cm Color: Gris medio (RAL 7035) Terminal giratorio</p> <p style="text-align: right;"><b>BAJO PEDIDO</b></p>
 	<p>Conexión instrumento: MC2, Isolite/LED, ISO300 con luz Conexión equipo: KaVo® 1057 y 1060</p> <p>Origen: Italia      Fabricante: Tekne Dental (TKD®)      Garantía: 12 meses</p> <p><b>Ref.: 40-52E6016</b> <span style="float: right;"><b>216<sup>80</sup>€</b></span></p>	<p>Longitud: 135cm Color: Gris medio (RAL 7035) Terminal giratorio</p> <p style="text-align: right;"><b>BAJO PEDIDO</b></p>



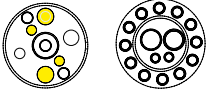
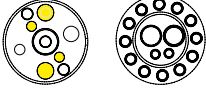
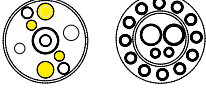
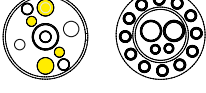
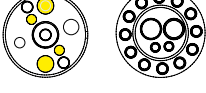
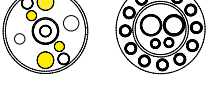
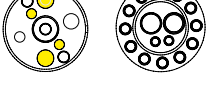
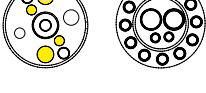

















**Mangueras para Micromotores Bien Air®: Conector a equipo KaVo®**

**Características**

	<p><b>Conexión instrumento:</b> MC2, Isolite/LED, ISO300 con luz  <b>Conexión equipo:</b> KaVo® 1057, 1058*, 1060, 1062, 1063, 1065, 1066, 1078, 1080 (*Excepto 1058 Primus Life) (Serie 1)</p> <p><b>Origen:</b> Italia      <b>Fabricante:</b> Tekne Dental (TKD®)      <b>Garantía:</b> 12 meses</p> <p><b>Ref.:</b> <b>40-52G6026</b>      <b>182<sup>80</sup>€</b></p>	<p><b>Longitud:</b> 120cm  <b>Color:</b> Gris medio (RAL 7035)</p> <p><b>BAJO PEDIDO</b></p>
	<p><b>Conexión instrumento:</b> MC2, Isolite/LED, ISO300 con luz  <b>Conexión equipo:</b> KaVo® 1057, 1058*, 1060, 1062, 1063, 1065, 1066, 1078, 1080 (*Excepto 1058 Primus Life) (Serie 1)</p> <p><b>Origen:</b> Italia      <b>Fabricante:</b> Tekne Dental (TKD®)      <b>Garantía:</b> 12 meses</p> <p><b>Ref.:</b> <b>40-52E6026</b>      <b>188<sup>00</sup>€</b></p>	<p><b>Longitud:</b> 135cm  <b>Color:</b> Gris medio (RAL 7035)</p> <p><b>BAJO PEDIDO</b></p>
	<p><b>Conexión instrumento:</b> MC2, Isolite/LED, ISO300 con luz  <b>Conexión equipo:</b> KaVo® 1057, 1058*, 1060, 1062, 1063, 1065, 1066, 1078, 1080 (*Excepto 1058 Primus Life) (Serie 1)</p> <p><b>Origen:</b> Italia      <b>Fabricante:</b> Tekne Dental (TKD®)      <b>Garantía:</b> 12 meses</p> <p><b>Ref.:</b> <b>40-52G6036</b>      <b>210<sup>80</sup>€</b></p>	<p><b>Longitud:</b> 120cm  <b>Color:</b> Gris medio (RAL 7035)  <b>Terminal giratorio</b></p> <p><b>BAJO PEDIDO</b></p>
	<p><b>Conexión instrumento:</b> MC2, Isolite/LED, ISO300 con luz  <b>Conexión equipo:</b> KaVo® 1057, 1058*, 1060, 1062, 1063, 1065, 1066, 1078, 1080 (*Excepto 1058 Primus Life) (Serie 1)</p> <p><b>Origen:</b> Italia      <b>Fabricante:</b> Tekne Dental (TKD®)      <b>Garantía:</b> 12 meses</p> <p><b>Ref.:</b> <b>40-52E6036</b>      <b>216<sup>80</sup>€</b></p>	<p><b>Longitud:</b> 135cm  <b>Color:</b> Gris medio (RAL 7035)  <b>Terminal giratorio</b></p> <p><b>BAJO PEDIDO</b></p>
	<p><b>Conexión instrumento:</b> MC2, Isolite/LED, ISO300 con luz  <b>Conexión equipo:</b> KaVo® E30S, E30T, E50S, Y E70S, excepto: E50T, E70T y E80T (Serie 2: sin sensor magnético)</p> <p><b>Origen:</b> Italia      <b>Fabricante:</b> Tekne Dental (TKD®)      <b>Garantía:</b> 12 meses</p> <p><b>Ref.:</b> <b>40-52G6046</b>      <b>198<sup>00</sup>€</b></p>	<p><b>Longitud:</b> 120cm  <b>Color:</b> Gris medio (RAL 7035)</p> <p><b>BAJO PEDIDO</b></p>
	<p><b>Conexión instrumento:</b> MC2, Isolite/LED, ISO300 con luz  <b>Conexión equipo:</b> KaVo® E30S, E30T, E50S, Y E70S, excepto: E50T, E70T y E80T (Serie 2: sin sensor magnético)</p> <p><b>Origen:</b> Italia      <b>Fabricante:</b> Tekne Dental (TKD®)      <b>Garantía:</b> 12 meses</p> <p><b>Ref.:</b> <b>40-52E6046</b>      <b>203<sup>80</sup>€</b></p>	<p><b>Longitud:</b> 135cm  <b>Color:</b> Gris medio (RAL 7035)</p> <p><b>BAJO PEDIDO</b></p>
	<p><b>Conexión instrumento:</b> MC2, Isolite/LED, ISO300 con luz  <b>Conexión equipo:</b> KaVo® E30S, E30T, E50S, Y E70S, excepto: E50T, E70T y E80T (Serie 2: sin sensor magnético)</p> <p><b>Origen:</b> Italia      <b>Fabricante:</b> Tekne Dental (TKD®)      <b>Garantía:</b> 12 meses</p> <p><b>Ref.:</b> <b>40-52G6056</b>      <b>222<sup>80</sup>€</b></p>	<p><b>Longitud:</b> 120cm  <b>Color:</b> Gris medio (RAL 7035)  <b>Terminal giratorio</b></p> <p><b>BAJO PEDIDO</b></p>
	<p><b>Conexión instrumento:</b> MC2, Isolite/LED, ISO300 con luz  <b>Conexión equipo:</b> KaVo® E30S, E30T, E50S, Y E70S, excepto: E50T, E70T y E80T (Serie 2: sin sensor magnético)</p> <p><b>Origen:</b> Italia      <b>Fabricante:</b> Tekne Dental (TKD®)      <b>Garantía:</b> 12 meses</p> <p><b>Ref.:</b> <b>40-52E6056</b>      <b>227<sup>80</sup>€</b></p>	<p><b>Longitud:</b> 135cm  <b>Color:</b> Gris medio (RAL 7035)  <b>Terminal giratorio</b></p> <p><b>BAJO PEDIDO</b></p>
	<p><b>Conexión instrumento:</b> MC3/LK/LED, con y sin luz  <b>Conexión equipo:</b> KaVo® 1057 y 1060</p> <p><b>Origen:</b> Italia      <b>Fabricante:</b> Tekne Dental (TKD®)      <b>Garantía:</b> 12 meses</p> <p><b>Ref.:</b> <b>40-52G6005</b>      <b>168<sup>00</sup>€</b></p>	<p><b>Longitud:</b> 120cm  <b>Color:</b> Gris medio (RAL 7035)</p> <p><b>BAJO PEDIDO</b></p>
	<p><b>Conexión instrumento:</b> MC3/LK/LED, con y sin luz  <b>Conexión equipo:</b> KaVo® 1057 y 1060</p> <p><b>Origen:</b> Italia      <b>Fabricante:</b> Tekne Dental (TKD®)      <b>Garantía:</b> 12 meses</p> <p><b>Ref.:</b> <b>40-52E6005</b>      <b>173<sup>80</sup>€</b></p>	<p><b>Longitud:</b> 135cm  <b>Color:</b> Gris medio (RAL 7035)</p> <p><b>BAJO PEDIDO</b></p>





















**Mangueras para Micromotores Bien Air®: Conector a equipo KaVo®**

**Características**

 	<p><b>Conexión instrumento:</b> MC3/LK/LED, con y sin luz  <b>Conexión equipo:</b> KaVo® 1057 y 1060</p> <p><b>Origen:</b> Italia      <b>Fabricante:</b> Tekne Dental (TKD®)      <b>Garantía:</b> 12 meses</p> <p><b>Ref.:</b> <b>40-52G6015</b>      <b>198<sup>00</sup>€</b></p>	<p><b>Longitud:</b> 120cm  <b>Color:</b> Gris medio (RAL 7035)  <b>Terminal giratorio</b></p> <p><b>BAJO PEDIDO</b></p>
 	<p><b>Conexión instrumento:</b> MC3/LK/LED, con y sin luz  <b>Conexión equipo:</b> KaVo® 1057 y 1060</p> <p><b>Origen:</b> Italia      <b>Fabricante:</b> Tekne Dental (TKD®)      <b>Garantía:</b> 12 meses</p> <p><b>Ref.:</b> <b>40-52E6015</b>      <b>203<sup>80</sup>€</b></p>	<p><b>Longitud:</b> 135cm  <b>Color:</b> Gris medio (RAL 7035)  <b>Terminal giratorio</b></p> <p><b>BAJO PEDIDO</b></p>
 	<p><b>Conexión instrumento:</b> MC3/LK/LED, con y sin luz  <b>Conexión equipo:</b> KaVo® 1057 y 1060</p> <p><b>Origen:</b> Italia      <b>Fabricante:</b> Tekne Dental (TKD®)      <b>Garantía:</b> 12 meses</p> <p><b>Ref.:</b> <b>40-52G6025</b>      <b>268<sup>00</sup>€</b></p>	<p><b>Longitud:</b> 120cm  <b>Color:</b> Gris medio (RAL 7035)  <b>Regulación de spray</b></p> <p><b>BAJO PEDIDO</b></p>
 	<p><b>Conexión instrumento:</b> MC3/LK/LED, con y sin luz  <b>Conexión equipo:</b> KaVo® 1057 y 1060</p> <p><b>Origen:</b> Italia      <b>Fabricante:</b> Tekne Dental (TKD®)      <b>Garantía:</b> 12 meses</p> <p><b>Ref.:</b> <b>40-52E6025</b>      <b>273<sup>80</sup>€</b></p>	<p><b>Longitud:</b> 135cm  <b>Color:</b> Gris medio (RAL 7035)  <b>Regulación de spray</b></p> <p><b>BAJO PEDIDO</b></p>
 	<p><b>Conexión instrumento:</b> MC3/LK/LED, con y sin luz  <b>Conexión equipo:</b> KaVo® 1057, 1058*, 1060, 1062, 1063, 1065, 1066, 1078, 1080 (*Excepto 1058 Primus Life) (Serie 1)</p> <p><b>Origen:</b> Italia      <b>Fabricante:</b> Tekne Dental (TKD®)      <b>Garantía:</b> 12 meses</p> <p><b>Ref.:</b> <b>40-52G6035</b>      <b>168<sup>00</sup>€</b></p>	<p><b>Longitud:</b> 120cm  <b>Color:</b> Gris medio (RAL 7035)</p> <p><b>BAJO PEDIDO</b></p>
 	<p><b>Conexión instrumento:</b> MC3/LK/LED, con y sin luz  <b>Conexión equipo:</b> KaVo® 1057, 1058*, 1060, 1062, 1063, 1065, 1066, 1078, 1080 (*Excepto 1058 Primus Life) (Serie 1)</p> <p><b>Origen:</b> Italia      <b>Fabricante:</b> Tekne Dental (TKD®)      <b>Garantía:</b> 12 meses</p> <p><b>Ref.:</b> <b>40-52E6035</b>      <b>173<sup>80</sup>€</b></p>	<p><b>Longitud:</b> 135cm  <b>Color:</b> Gris medio (RAL 7035)</p> <p><b>BAJO PEDIDO</b></p>
 	<p><b>Conexión instrumento:</b> MC3/LK/LED, con y sin luz  <b>Conexión equipo:</b> KaVo® 1057, 1058*, 1060, 1062, 1063, 1065, 1066, 1078, 1080 (*Excepto 1058 Primus Life) (Serie 1)</p> <p><b>Origen:</b> Italia      <b>Fabricante:</b> Tekne Dental (TKD®)      <b>Garantía:</b> 12 meses</p> <p><b>Ref.:</b> <b>40-52G6045</b>      <b>198<sup>00</sup>€</b></p>	<p><b>Longitud:</b> 120cm  <b>Color:</b> Gris medio (RAL 7035)  <b>Terminal giratorio</b></p> <p><b>BAJO PEDIDO</b></p>
 	<p><b>Conexión instrumento:</b> MC3/LK/LED, con y sin luz  <b>Conexión equipo:</b> KaVo® 1057, 1058*, 1060, 1062, 1063, 1065, 1066, 1078, 1080 (*Excepto 1058 Primus Life) (Serie 1)</p> <p><b>Origen:</b> Italia      <b>Fabricante:</b> Tekne Dental (TKD®)      <b>Garantía:</b> 12 meses</p> <p><b>Ref.:</b> <b>40-52E6045</b>      <b>203<sup>80</sup>€</b></p>	<p><b>Longitud:</b> 135cm  <b>Color:</b> Gris medio (RAL 7035)  <b>Terminal giratorio</b></p> <p><b>BAJO PEDIDO</b></p>
 	<p><b>Conexión instrumento:</b> MC3/LK/LED, con y sin luz  <b>Conexión equipo:</b> KaVo® 1057, 1058*, 1060, 1062, 1063, 1065, 1066, 1078, 1080 (*Excepto 1058 Primus Life) (Serie 1)</p> <p><b>Origen:</b> Italia      <b>Fabricante:</b> Tekne Dental (TKD®)      <b>Garantía:</b> 12 meses</p> <p><b>Ref.:</b> <b>40-52G6055</b>      <b>268<sup>00</sup>€</b></p>	<p><b>Longitud:</b> 120cm  <b>Color:</b> Gris medio (RAL 7035)  <b>Regulación de spray</b></p> <p><b>BAJO PEDIDO</b></p>
 	<p><b>Conexión instrumento:</b> MC3/LK/LED, con y sin luz  <b>Conexión equipo:</b> KaVo® 1057, 1058*, 1060, 1062, 1063, 1065, 1066, 1078, 1080 (*Excepto 1058 Primus Life) (Serie 1)</p> <p><b>Origen:</b> Italia      <b>Fabricante:</b> Tekne Dental (TKD®)      <b>Garantía:</b> 12 meses</p> <p><b>Ref.:</b> <b>40-52E6055</b>      <b>273<sup>80</sup>€</b></p>	<p><b>Longitud:</b> 135cm  <b>Color:</b> Gris medio (RAL 7035)  <b>Regulación de spray</b></p> <p><b>BAJO PEDIDO</b></p>

**Mangueras para Micromotores Bien Air®: Conector a equipo KaVo®**

**Características**

 	<p><b>Conexión instrumento:</b> MC3/LK/LED, con y sin luz  <b>Conexión equipo:</b> KaVo® E30S, E30T, E50S, Y E70S, excepto: E50T, E70T y E80T (Serie 2: sin sensor magnético)</p> <p><b>Origen:</b> Italia      <b>Fabricante:</b> Tekne Dental (TKD®)      <b>Garantía:</b> 12 meses</p> <p><b>Ref.:</b> <b>40-52G6065</b>      <b>178<sup>00</sup>€</b></p>	<p><b>Longitud:</b> 120cm  <b>Color:</b> Gris medio (RAL 7035)</p> <p><b>BAJO PEDIDO</b></p>
 	<p><b>Conexión instrumento:</b> MC3/LK/LED, con y sin luz  <b>Conexión equipo:</b> KaVo® E30S, E30T, E50S, Y E70S, excepto: E50T, E70T y E80T (Serie 2: sin sensor magnético)</p> <p><b>Origen:</b> Italia      <b>Fabricante:</b> Tekne Dental (TKD®)      <b>Garantía:</b> 12 meses</p> <p><b>Ref.:</b> <b>40-52E6065</b>      <b>183<sup>80</sup>€</b></p>	<p><b>Longitud:</b> 135cm  <b>Color:</b> Gris medio (RAL 7035)</p> <p><b>BAJO PEDIDO</b></p>
 	<p><b>Conexión instrumento:</b> MC3/LK/LED, con y sin luz  <b>Conexión equipo:</b> KaVo® E30S, E30T, E50S, Y E70S, excepto: E50T, E70T y E80T (Serie 2: sin sensor magnético)</p> <p><b>Origen:</b> Italia      <b>Fabricante:</b> Tekne Dental (TKD®)      <b>Garantía:</b> 12 meses</p> <p><b>Ref.:</b> <b>40-52G6075</b>      <b>206<sup>80</sup>€</b></p>	<p><b>Longitud:</b> 120cm  <b>Color:</b> Gris medio (RAL 7035)  <b>Terminal giratorio</b></p> <p><b>BAJO PEDIDO</b></p>
 	<p><b>Conexión instrumento:</b> MC3/LK/LED, con y sin luz  <b>Conexión equipo:</b> KaVo® E30S, E30T, E50S, Y E70S, excepto: E50T, E70T y E80T (Serie 2: sin sensor magnético)</p> <p><b>Origen:</b> Italia      <b>Fabricante:</b> Tekne Dental (TKD®)      <b>Garantía:</b> 12 meses</p> <p><b>Ref.:</b> <b>40-52E6075</b>      <b>212<sup>80</sup>€</b></p>	<p><b>Longitud:</b> 135cm  <b>Color:</b> Gris medio (RAL 7035)  <b>Terminal giratorio</b></p> <p><b>BAJO PEDIDO</b></p>
 	<p><b>Conexión instrumento:</b> MC3/LK/LED, con y sin luz  <b>Conexión equipo:</b> KaVo® E30S, E30T, E50S, Y E70S, excepto: E50T, E70T y E80T (Serie 2: sin sensor magnético)</p> <p><b>Origen:</b> Italia      <b>Fabricante:</b> Tekne Dental (TKD®)      <b>Garantía:</b> 12 meses</p> <p><b>Ref.:</b> <b>40-52G6085</b>      <b>294<sup>80</sup>€</b></p>	<p><b>Longitud:</b> 120cm  <b>Color:</b> Gris medio (RAL 7035)  <b>Regulación de spray</b></p> <p><b>BAJO PEDIDO</b></p>
 	<p><b>Conexión instrumento:</b> MC3/LK/LED, con y sin luz  <b>Conexión equipo:</b> KaVo® E30S, E30T, E50S, Y E70S, excepto: E50T, E70T y E80T (Serie 2: sin sensor magnético)</p> <p><b>Origen:</b> Italia      <b>Fabricante:</b> Tekne Dental (TKD®)      <b>Garantía:</b> 12 meses</p> <p><b>Ref.:</b> <b>40-52E6085</b>      <b>299<sup>80</sup>€</b></p>	<p><b>Longitud:</b> 135cm  <b>Color:</b> Gris medio (RAL 7035)  <b>Regulación de spray</b></p> <p><b>BAJO PEDIDO</b></p>
 	<p><b>Conexión instrumento:</b> MC3/LK/LED + turbina, Polivalente, con y sin luz  <b>Conexión equipo:</b> KaVo® 1057 y 1060</p> <p><b>Origen:</b> Italia      <b>Fabricante:</b> Tekne Dental (TKD®)      <b>Garantía:</b> 12 meses</p> <p><b>Ref.:</b> <b>40-52G6003</b>      <b>198<sup>00</sup>€</b></p>	<p><b>Longitud:</b> 120cm  <b>Color:</b> Gris medio (RAL 7035)</p> <p><b>BAJO PEDIDO</b></p>
 	<p><b>Conexión instrumento:</b> MC3/LK/LED + turbina, Polivalente, con y sin luz  <b>Conexión equipo:</b> KaVo® 1057 y 1060</p> <p><b>Origen:</b> Italia      <b>Fabricante:</b> Tekne Dental (TKD®)      <b>Garantía:</b> 12 meses</p> <p><b>Ref.:</b> <b>40-52E6003</b>      <b>203<sup>80</sup>€</b></p>	<p><b>Longitud:</b> 135cm  <b>Color:</b> Gris medio (RAL 7035)</p> <p><b>BAJO PEDIDO</b></p>
 	<p><b>Conexión instrumento:</b> MC3/LK/LED + turbina, Polivalente, con y sin luz  <b>Conexión equipo:</b> KaVo® 1057, 1058*, 1060, 1062, 1063, 1065, 1066, 1078, 1080 (*Excepto 1058 Primus Life) (Serie 1)</p> <p><b>Origen:</b> Italia      <b>Fabricante:</b> Tekne Dental (TKD®)      <b>Garantía:</b> 12 meses</p> <p><b>Ref.:</b> <b>40-52G6013</b>      <b>198<sup>00</sup>€</b></p>	<p><b>Longitud:</b> 120cm  <b>Color:</b> Gris medio (RAL 7035)</p> <p><b>BAJO PEDIDO</b></p>
 	<p><b>Conexión instrumento:</b> MC3/LK/LED + turbina, Polivalente, con y sin luz  <b>Conexión equipo:</b> KaVo® 1057, 1058*, 1060, 1062, 1063, 1065, 1066, 1078, 1080 (*Excepto 1058 Primus Life) (Serie 1)</p> <p><b>Origen:</b> Italia      <b>Fabricante:</b> Tekne Dental (TKD®)      <b>Garantía:</b> 12 meses</p> <p><b>Ref.:</b> <b>40-52E6013</b>      <b>203<sup>80</sup>€</b></p>	<p><b>Longitud:</b> 135cm  <b>Color:</b> Gris medio (RAL 7035)</p> <p><b>BAJO PEDIDO</b></p>

		Mangueras para Micromotores Bien Air®: Conector a equipo KaVo®	Características
		<p><b>Conexión instrumento:</b> MC3/LK/LED + turbina, Polivalente, con y sin luz</p> <p><b>Conexión equipo:</b> KaVo® E30S, E30T, E50S, Y E70S, excepto: E50T, E70T y E80T (Serie 2: sin sensor magnético)</p> <p><b>Origen:</b> Italia      <b>Fabricante:</b> Tekne Dental (TKD®)      <b>Garantía:</b> 12 meses</p> <p><b>Ref.:</b> <b>40-52G6023</b>      <b>206<sup>80</sup>€</b></p>	<p><b>Longitud:</b> 120cm</p> <p><b>Color:</b> Gris medio (RAL 7035)</p> <p><b>BAJO PEDIDO</b></p>
		<p><b>Conexión instrumento:</b> MC3/LK/LED + turbina, Polivalente, con y sin luz</p> <p><b>Conexión equipo:</b> KaVo® E30S, E30T, E50S, Y E70S, excepto: E50T, E70T y E80T (Serie 2: sin sensor magnético)</p> <p><b>Origen:</b> Italia      <b>Fabricante:</b> Tekne Dental (TKD®)      <b>Garantía:</b> 12 meses</p> <p><b>Ref.:</b> <b>40-52E6023</b>      <b>212<sup>80</sup>€</b></p>	<p><b>Longitud:</b> 135cm</p> <p><b>Color:</b> Gris medio (RAL 7035)</p> <p><b>BAJO PEDIDO</b></p>

**Mangueras para Micromotores Bien Air®: Conector a equipo Planmeca®** RUMAR

		Mangueras para Micromotores Bien Air®: Conector a equipo Planmeca®	Características
		<p><b>Conexión instrumento:</b> Bien Air® MC2 e ISOLITE 300, con luz</p> <p><b>Conexión equipo:</b> Planmeca®</p> <p><b>Origen:</b> Italia      <b>Fabricante:</b> Tekne Dental (TKD®)      <b>Garantía:</b> 12 meses</p> <p><b>Ref.:</b> <b>40-52M1001</b> (Ref. Planmeca®: 2600282-2)      <b>278<sup>00</sup>€</b></p>	<p><b>Longitud:</b> 103cm</p> <p><b>Color:</b> Gris claro (RAL 9002)</p> <p><b>Terminal giratorio:</b> 143 Ohm</p> <p><b>Resistencia:</b> 143 Ohm</p> <p><b>BAJO PEDIDO</b></p>
		<p><b>Conexión instrumento:</b> Bien Air® MC3</p> <p><b>Conexión equipo:</b> Planmeca®</p> <p><b>Origen:</b> Italia      <b>Fabricante:</b> Tekne Dental (TKD®)      <b>Garantía:</b> 12 meses</p> <p><b>Ref.:</b> <b>40-52M1009</b> (Ref. Planmeca®: J10044908-1)      <b>228<sup>00</sup>€</b></p>	<p><b>Longitud:</b> 100cm</p> <p><b>Color:</b> Gris claro (RAL9002)</p> <p><b>Terminal giratorio:</b> 400°</p> <p><b>Resistencia:</b> 82 Ohm</p>
		<p><b>Conexión instrumento:</b> Bien Air® MC3</p> <p><b>Conexión equipo:</b> Planmeca®</p> <p><b>Origen:</b> Italia      <b>Fabricante:</b> Tekne Dental (TKD®)      <b>Garantía:</b> 12 meses</p> <p><b>Ref.:</b> <b>40-52D1009</b>      <b>259<sup>80</sup>€</b></p>	<p><b>Longitud:</b> 150cm</p> <p><b>Color:</b> Gris claro (RAL9002)</p> <p><b>Terminal giratorio:</b> 400°</p> <p><b>Resistencia:</b> 82 Ohm</p> <p><b>BAJO PEDIDO</b></p>
		<p><b>Conexión instrumento:</b> Polivalente Bien Air® MC3 + Turbina, Polivalente</p> <p><b>Conexión equipo:</b> Planmeca®</p> <p><b>Origen:</b> Italia      <b>Fabricante:</b> Tekne Dental (TKD®)      <b>Garantía:</b> 12 meses</p> <p><b>Ref.:</b> <b>40-52M1003</b> (Ref. Planmeca®: J10044909-1)      <b>238<sup>00</sup>€</b></p>	<p><b>Longitud:</b> 98cm</p> <p><b>Color:</b> Gris claro (RAL9002)</p> <p><b>Resistencia:</b> 82 Ohm</p> <p><b>BAJO PEDIDO</b></p>
		<p><b>Conexión instrumento:</b> Polivalente Bien Air® MC3 + Turbina, Polivalente</p> <p><b>Conexión equipo:</b> Planmeca®</p> <p><b>Origen:</b> Italia      <b>Fabricante:</b> Tekne Dental (TKD®)      <b>Garantía:</b> 12 meses</p> <p><b>Ref.:</b> <b>40-52K1003</b>      <b>238<sup>00</sup>€</b></p>	<p><b>Longitud:</b> 90cm</p> <p><b>Color:</b> Gris claro (RAL 9002)</p> <p><b>Resistencia:</b> 82 Ohm</p> <p><b>BAJO PEDIDO</b></p>
		<p><b>Conexión instrumento:</b> Polivalente Bien Air® MC3 + Turbina, Polivalente</p> <p><b>Conexión equipo:</b> Planmeca®</p> <p><b>Origen:</b> Italia      <b>Fabricante:</b> Tekne Dental (TKD®)      <b>Garantía:</b> 12 meses</p> <p><b>Ref.:</b> <b>40-52D1003</b>      <b>230<sup>80</sup>€</b></p>	<p><b>Longitud:</b> 150cm</p> <p><b>Color:</b> Gris claro (RAL 9002)</p> <p><b>Resistencia:</b> 82 Ohm</p> <p><b>BAJO PEDIDO</b></p>

## Mangueras para Micromotores Bien Air®: Conector a equipo Sirona®

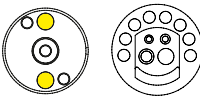
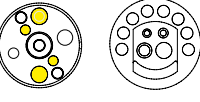
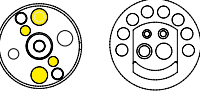
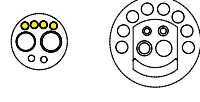
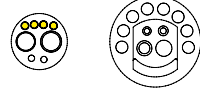
Mangueras para Micromotores Bien Air®: Conector a equipo Sirona®		Características
	<p><b>Conexión instrumento:</b> Bien Air® MC2 IR <b>Conexión equipo:</b> A1, A2, A4, A5, AC, C1, C1+, C2, C2+, C4.</p> <p><b>Origen:</b> Italia      <b>Fabricante:</b> Tekne Dental (TKD®)      <b>Garantía:</b> 12 meses</p> <p><b>Ref.:</b> <b>40-52L1002</b>      <b>195<sup>80</sup>€</b></p>	<p><b>Longitud:</b> 137cm <b>Color:</b> Gris claro (RAL 9002)</p> <p><b>BAJO PEDIDO</b></p>
	<p><b>Conexión instrumento:</b> Bien Air® MC2 e Isolite 300, con luz <b>Conexión equipo:</b> A1, A2, A4, A5, AC, C1, C1+, C2, C2+, C4.</p> <p><b>Origen:</b> Italia      <b>Fabricante:</b> Tekne Dental (TKD®)      <b>Garantía:</b> 12 meses</p> <p><b>Ref.:</b> <b>40-52L1006</b>      <b>258<sup>00</sup>€</b></p>	<p><b>Longitud:</b> 137cm <b>Color:</b> Gris claro (RAL 9002)</p>
	<p><b>Conexión instrumento:</b> Bien Air® MC2 e Isolite 300, con luz <b>Conexión equipo:</b> A1, A2, A4, A5, AC, C1, C1+, C2, C2+, C4.</p> <p><b>Origen:</b> Italia      <b>Fabricante:</b> Tekne Dental (TKD®)      <b>Garantía:</b> 12 meses</p> <p><b>Ref.:</b> <b>40-52L1007</b>      <b>252<sup>80</sup>€</b></p>	<p><b>Longitud:</b> 137cm <b>Color:</b> Gris claro (RAL 9002) <b>Terminal giratorio</b></p> <p><b>BAJO PEDIDO</b></p>
	<p><b>Conexión instrumento:</b> Bien Air® MC3 <b>Conexión equipo:</b> A1, A2, A4, A5, AC, C1, C1+, C2, C2+, C4, C4+, C5+, C8, C8+, E1, E2, E4, EC, M1, M1+, PROFEEL, SPIRIT, SI, S2.</p> <p><b>Origen:</b> Italia      <b>Fabricante:</b> Tekne Dental (TKD®)      <b>Garantía:</b> 12 meses</p> <p><b>Ref.:</b> <b>40-52L1008</b>      <b>298<sup>00</sup>€</b></p>	<p><b>Longitud:</b> 137cm <b>Color:</b> Gris claro (RAL 9002) <b>Regulación de spray</b></p>
	<p><b>Conexión instrumento:</b> Bien Air® MC3 <b>Conexión equipo:</b> M1, C6 y E3, M1+, MI96, C3, C3+.</p> <p><b>Origen:</b> Italia      <b>Fabricante:</b> Tekne Dental (TKD®)      <b>Garantía:</b> 12 meses</p> <p><b>Ref.:</b> <b>40-52L1005</b>      <b>268<sup>00</sup>€</b></p>	<p><b>Longitud:</b> 137cm <b>Color:</b> Gris claro (RAL 9002) <b>Terminal giratorio:</b> 400°</p>

## Mangueras para Micromotores Cefla®

Conexión a equipo: **Abierta / Open end** > **Cefla®** > **KaVo®** > **Planmeca®** > **Sirona®**

## Mangueras para Micromotores Cefla®: Conexión Abierta / Open End

Mangueras para Micromotores Cefla®: Conexión Abierta / Open End		Características
	<p><b>Conexión instrumento:</b> Anthos® iMMrL, iMMr; Stern Weber® iXR3L, iXR3; Castellini® Handy Power y Handy Power LED <b>Conexión equipo:</b> Abierta</p> <p><b>Origen:</b> Italia      <b>Fabricante:</b> Tekne Dental (TKD®)      <b>Garantía:</b> 12 meses</p> <p><b>Ref.:</b> <b>40-51A2901</b>      <b>189<sup>80</sup>€</b></p>	<p><b>Longitud:</b> 160cm <b>Color:</b> Gris oscuro (RAL 7038)</p>
	<p><b>Conexión instrumento:</b> Anthos® iMMrL, iMMr; Stern Weber® iXR3L, iXR3; Castellini® Handy Power y Handy Power LED <b>Conexión equipo:</b> Abierta</p> <p><b>Origen:</b> Italia      <b>Fabricante:</b> Tekne Dental (TKD®)      <b>Garantía:</b> 12 meses</p> <p><b>Ref.:</b> <b>40-51A2902</b>      <b>228<sup>00</sup>€</b></p>	<p><b>Longitud:</b> 160cm <b>Color:</b> Gris oscuro (RAL 7038) <b>Terminal giratorio</b></p> <p><b>BAJO PEDIDO</b></p>
	<p><b>Conexión instrumento:</b> Anthos® iMMs, Stern Weber® iXS4, Castellini® Implantor LED (Equipos hasta 2015, conector micromotor negro) <b>Conexión equipo:</b> Abierta</p> <p><b>Origen:</b> Italia      <b>Fabricante:</b> Tekne Dental (TKD®)      <b>Garantía:</b> 12 meses</p> <p><b>Ref.:</b> <b>40-51A2905</b>      <b>214<sup>80</sup>€</b></p>	<p><b>Longitud:</b> 160cm <b>Color:</b> Gris oscuro (RAL 7038)</p> <p><b>BAJO PEDIDO</b></p>

**Mangueras para Micromotores Cefla®: Conexión Abierta / Open End**

**Características**

	<p><b>Conexión instrumento:</b> Anthos® iMMs, Stern Weber® iXS4, Castellini® Implantor LED (Equipos hasta 2015, conector micromotor negro)</p> <p><b>Conexión equipo:</b> Abierta</p> <p><b>Origen:</b> Italia      <b>Fabricante:</b> Tekne Dental (TKD®)      <b>Garantía:</b> 12 meses</p>	<p><b>Longitud:</b> 160cm <b>Color:</b> Gris oscuro (RAL 7038) <b>Terminal giratorio</b></p>
	<p><b>Ref.:</b> <b>40-51A2906</b></p>	<p><b>228<sup>00</sup>€</b> <span style="float: right; background-color: green; color: white; padding: 2px 5px;">BAJO PEDIDO</span></p>
	<p><b>Conexión instrumento:</b> Anthos® iMMs, Stern Weber® iXS4, Castellini® Implantor LED (Equipos desde 2016, conector micromotor blanco)</p> <p><b>Conexión equipo:</b> Abierta</p> <p><b>Origen:</b> Italia      <b>Fabricante:</b> Tekne Dental (TKD®)      <b>Garantía:</b> 12 meses</p>	<p><b>Longitud:</b> 160cm <b>Color:</b> Gris oscuro (RAL 7038)</p>
	<p><b>Ref.:</b> <b>40-51A2903</b></p>	<p><b>238<sup>00</sup>€</b> <span style="float: right; background-color: green; color: white; padding: 2px 5px;">BAJO PEDIDO</span></p>
	<p><b>Conexión instrumento:</b> Anthos® iMMs, Stern Weber® iXS4, Castellini® Implantor LED (Equipos desde 2016, conector micromotor blanco)</p> <p><b>Conexión equipo:</b> Abierta</p> <p><b>Origen:</b> Italia      <b>Fabricante:</b> Tekne Dental (TKD®)      <b>Garantía:</b> 12 meses</p>	<p><b>Longitud:</b> 160cm <b>Color:</b> Gris oscuro (RAL 7038) <b>Terminal giratorio</b></p>
	<p><b>Ref.:</b> <b>40-51A2904</b></p>	<p><b>258<sup>00</sup>€</b> <span style="float: right; background-color: green; color: white; padding: 2px 5px;">BAJO PEDIDO</span></p>

**Mangueras para Micromotores Cefla®: Conector a equipo Cefla® (desde 2006) Anthos, Stern Weber, Castellini**















**Mangueras para Micromotores Cefla®: Conector a equipo Cefla® (desde 2006)**

**Características**

		<p><b>Conexión instrumento:</b> Anthos® iMMs, Stern Weber® iXS4, Castellini® Implantor LED (Equipos hasta 2015, conector micromotor negro)</p> <p><b>Conexión equipo:</b> Cefla®: Anthos®: A7 Plus, L9 y R7 ; Stern Weber®: S320TR, S280TRC, S300 y S380TRC; Castellini®: SKEMA 5, SKEMA 6, SKEMA 8, PUMA ELI</p> <p><b>Origen:</b> Italia      <b>Fabricante:</b> Tekne Dental (TKD®)      <b>Garantía:</b> 12 meses</p>	<p><b>Longitud:</b> 135cm <b>Color:</b> Gris oscuro (RAL 7038)</p>
		<p><b>Ref.:</b> <b>40-52E2905</b></p>	<p><b>288<sup>00</sup>€</b></p>
		<p><b>Conexión instrumento:</b> Anthos® iMMs, Stern Weber® iXS4, Castellini® Implantor LED (Equipos hasta 2015, conector micromotor negro)</p> <p><b>Conexión equipo:</b> Cefla®: Anthos®: A7 Plus, L9 y R7 ; Stern Weber®: S320TR, S280TRC, S300 y S380TRC; Castellini®: SKEMA 5, SKEMA 6, SKEMA 8, PUMA ELI</p> <p><b>Origen:</b> Italia      <b>Fabricante:</b> Tekne Dental (TKD®)      <b>Garantía:</b> 12 meses</p>	<p><b>Longitud:</b> 120cm <b>Color:</b> Gris oscuro (RAL 7038)</p>
		<p><b>Ref.:</b> <b>40-52G2905</b></p>	<p><b>278<sup>00</sup>€</b></p>
		<p><b>Conexión instrumento:</b> Anthos® iMMs, Stern Weber® iXS4, Castellini® Implantor LED (Equipos hasta 2015, conector micromotor negro)</p> <p><b>Conexión equipo:</b> Cefla®: Anthos®: A7 Plus, L9 y R7 ; Stern Weber®: S320TR, S280TRC, S300 y S380TRC; Castellini®: SKEMA 5, SKEMA 6, SKEMA 8, PUMA ELI</p> <p><b>Origen:</b> Italia      <b>Fabricante:</b> Tekne Dental (TKD®)      <b>Garantía:</b> 12 meses</p>	<p><b>Longitud:</b> 135cm <b>Color:</b> Gris oscuro (RAL 7038) <b>Terminal giratorio</b></p>
		<p><b>Ref.:</b> <b>40-52E2906</b></p>	<p><b>314<sup>80</sup>€</b> <span style="float: right; background-color: green; color: white; padding: 2px 5px;">BAJO PEDIDO</span></p>
		<p><b>Conexión instrumento:</b> Anthos® iMMs, Stern Weber® iXS4, Castellini® Implantor LED (Equipos hasta 2015, conector micromotor negro)</p> <p><b>Conexión equipo:</b> Cefla®: Anthos®: A7 Plus, L9 y R7 ; Stern Weber®: S320TR, S280TRC, S300 y S380TRC; Castellini®: SKEMA 5, SKEMA 6, SKEMA 8, PUMA ELI</p> <p><b>Origen:</b> Italia      <b>Fabricante:</b> Tekne Dental (TKD®)      <b>Garantía:</b> 12 meses</p>	<p><b>Longitud:</b> 120cm <b>Color:</b> Gris oscuro (RAL 7038) <b>Terminal giratorio</b></p>
		<p><b>Ref.:</b> <b>40-52G2906</b></p>	<p><b>309<sup>80</sup>€</b> <span style="float: right; background-color: green; color: white; padding: 2px 5px;">BAJO PEDIDO</span></p>
		<p><b>Conexión instrumento:</b> Anthos® iMMs, Stern Weber® iXS4, Castellini® Implantor LED (Equipos desde 2016, conector micromotor blanco)</p> <p><b>Conexión equipo:</b> Cefla®: Anthos®: A7 Plus, L9 y R7 ; Stern Weber®: S320TR, S280TRC, S300 y S380TRC; Castellini®: SKEMA 5, SKEMA 6, SKEMA 8, PUMA ELI</p> <p><b>Origen:</b> Italia      <b>Fabricante:</b> Tekne Dental (TKD®)      <b>Garantía:</b> 12 meses</p>	<p><b>Longitud:</b> 135cm <b>Color:</b> Gris oscuro (RAL 7038)</p>
		<p><b>Ref.:</b> <b>40-52E2903</b></p>	<p><b>294<sup>80</sup>€</b></p>
		<p><b>Conexión instrumento:</b> Anthos® iMMs, Stern Weber® iXS4, Castellini® Implantor LED (Equipos desde 2016, conector micromotor blanco)</p> <p><b>Conexión equipo:</b> Cefla®: Anthos®: A7 Plus, L9 y R7 ; Stern Weber®: S320TR, S280TRC, S300 y S380TRC; Castellini®: SKEMA 5, SKEMA 6, SKEMA 8, PUMA ELI</p> <p><b>Origen:</b> Italia      <b>Fabricante:</b> Tekne Dental (TKD®)      <b>Garantía:</b> 12 meses</p>	<p><b>Longitud:</b> 120cm <b>Color:</b> Gris oscuro (RAL 7038)</p>
		<p><b>Ref.:</b> <b>40-52G2903</b></p>	<p><b>288<sup>00</sup>€</b></p>

## Mangueras para Micromotores Cefla®: Conector a equipo Cefla® (desde 2006)

## Características

 	<p><b>Conexión instrumento:</b> Anthos® iMMs, Stern Weber® iXS4, Castellini® Implantor LED (Equipos desde 2016, conector micromotor blanco)</p> <p><b>Conexión equipo:</b> Cefla®: Anthos®: A7 Plus, L9 y R7 ; Stern Weber®: S320TR, S280TRC, S300 y S380TRC; Castellini®: SKEMA 5, SKEMA 6, SKEMA 8, PUMA ELI</p> <p><b>Origen:</b> Italia      <b>Fabricante:</b> Tekne Dental (TKD®)      <b>Garantía:</b> 12 meses</p> <p><b>Ref.:</b> <b>40-52E2904</b> <span style="float: right;"><b>334<sup>80</sup>€</b></span></p>	<p><b>Longitud:</b> 135cm <b>Color:</b> Gris oscuro (RAL 7038) <b>Terminal giratorio</b></p> <p style="text-align: right;"><b>BAJO PEDIDO</b></p>
 	<p><b>Conexión instrumento:</b> Anthos® iMMs, Stern Weber® iXS4, Castellini® Implantor LED (Equipos desde 2016, conector micromotor blanco)</p> <p><b>Conexión equipo:</b> Cefla®: Anthos®: A7 Plus, L9 y R7 ; Stern Weber®: S320TR, S280TRC, S300 y S380TRC; Castellini®: SKEMA 5, SKEMA 6, SKEMA 8, PUMA ELI</p> <p><b>Origen:</b> Italia      <b>Fabricante:</b> Tekne Dental (TKD®)      <b>Garantía:</b> 12 meses</p> <p><b>Ref.:</b> <b>40-52G2904</b> <span style="float: right;"><b>328<sup>00</sup>€</b></span></p>	<p><b>Longitud:</b> 120cm <b>Color:</b> Gris oscuro (RAL 7038) <b>Terminal giratorio</b></p> <p style="text-align: right;"><b>BAJO PEDIDO</b></p>
 	<p><b>Conexión instrumento:</b> Anthos® iMMrL, iMMr; Stern Weber® iXR3L, iXR3; Castellini® Handy Power y Handy Power LED (Equipos desde 2016, conector micromotor blanco)</p> <p><b>Conexión equipo:</b> Cefla®: Anthos®: A3 Plus, A5, A6 Plus, L6 y R7 ; Stern Weber®: S200, S220TR, S280TRC y S300; Castellini®: SKEMA 5, SKEMA 6 cart</p> <p><b>Origen:</b> Italia      <b>Fabricante:</b> Tekne Dental (TKD®)      <b>Garantía:</b> 12 meses</p> <p><b>Ref.:</b> <b>40-52E2901</b> <span style="float: right;"><b>264<sup>80</sup>€</b></span></p>	<p><b>Longitud:</b> 135cm <b>Color:</b> Gris oscuro (RAL 7038)</p> <p style="text-align: right;"><b>BAJO PEDIDO</b></p>
 	<p><b>Conexión instrumento:</b> Anthos® iMMrL, iMMr; Stern Weber® iXR3L, iXR3; Castellini® Handy Power y Handy Power LED (Equipos desde 2016, conector micromotor blanco)</p> <p><b>Conexión equipo:</b> Cefla®: Anthos®: A3 Plus, A5, A6 Plus, L6 y R7 ; Stern Weber®: S200, S220TR, S280TRC y S300; Castellini®: SKEMA 5, SKEMA 6 cart</p> <p><b>Origen:</b> Italia      <b>Fabricante:</b> Tekne Dental (TKD®)      <b>Garantía:</b> 12 meses</p> <p><b>Ref.:</b> <b>40-52G2901</b> <span style="float: right;"><b>259<sup>80</sup>€</b></span></p>	<p><b>Longitud:</b> 120cm <b>Color:</b> Gris oscuro (RAL 7038)</p>
 	<p><b>Conexión instrumento:</b> Anthos® iMMrL, iMMr; Stern Weber® iXR3L, iXR3; Castellini® Handy Power y Handy Power LED (Equipos desde 2016, conector micromotor blanco)</p> <p><b>Conexión equipo:</b> Cefla®: Anthos®: A3 Plus, A5, A6 Plus, L6 y R7 ; Stern Weber®: S200, S220TR, S280TRC y S300; Castellini®: SKEMA 5, SKEMA 6 cart</p> <p><b>Origen:</b> Italia      <b>Fabricante:</b> Tekne Dental (TKD®)      <b>Garantía:</b> 12 meses</p> <p><b>Ref.:</b> <b>40-52E2902</b> <span style="float: right;"><b>284<sup>80</sup>€</b></span></p>	<p><b>Longitud:</b> 135cm <b>Color:</b> Gris oscuro (RAL 7038) <b>Terminal giratorio</b></p> <p style="text-align: right;"><b>BAJO PEDIDO</b></p>
 	<p><b>Conexión instrumento:</b> Anthos® iMMrL, iMMr; Stern Weber® iXR3L, iXR3; Castellini® Handy Power y Handy Power LED (Equipos desde 2016, conector micromotor blanco)</p> <p><b>Conexión equipo:</b> Cefla®: Anthos®: A3 Plus, A5, A6 Plus, L6 y R7 ; Stern Weber®: S200, S220TR, S280TRC y S300; Castellini®: SKEMA 5, SKEMA 6 cart</p> <p><b>Origen:</b> Italia      <b>Fabricante:</b> Tekne Dental (TKD®)      <b>Garantía:</b> 12 meses</p> <p><b>Ref.:</b> <b>40-52G2902</b> <span style="float: right;"><b>279<sup>80</sup>€</b></span></p>	<p><b>Longitud:</b> 120cm <b>Color:</b> Gris oscuro (RAL 7038) <b>Terminal giratorio</b></p> <p style="text-align: right;"><b>BAJO PEDIDO</b></p>

## Mangueras para Micromotores Chirana®

CONSULTAR sección Mangueras para Micromotores KaVo®

# Mangueras para Micromotores KaVo®

Conexión a equipo: **Abierta / Open end** > Cefla® > KaVo® > Planmecca® > Sirona®

## Mangueras para Micromotores KaVo®: Conexión Abierta / Open End

RUMAR



### Mangueras para Micromotores KaVo®: Conexión Abierta / Open End

### Características

	<p><b>Conexión instrumento:</b> Micromotor KaVo® K190, K196, K197 y K200 y Chirana® Medical CH660 L</p> <p><b>Conexión equipo:</b> Abierta</p> <p><b>Origen:</b> Italia      <b>Fabricante:</b> Tekne Dental (TKD®)      <b>Garantía:</b> 12 meses</p> <p><b>Ref.:</b> <b>40-51B1200</b>      <b>128<sup>00</sup>€</b></p>	<p><b>Longitud:</b> 200cm</p> <p><b>Color:</b> Gris claro (RAL 9002)</p>
	<p><b>Conexión instrumento:</b> Micromotor KaVo® K190, K196, K197 y K200 y Chirana® Medical CH660 L</p> <p><b>Conexión equipo:</b> Abierta</p> <p><b>Origen:</b> Italia      <b>Fabricante:</b> Tekne Dental (TKD®)      <b>Garantía:</b> 12 meses</p> <p><b>Ref.:</b> <b>40-51B1201</b>      <b>161<sup>80</sup>€</b></p>	<p><b>Longitud:</b> 200cm</p> <p><b>Color:</b> Gris claro (RAL 9002)</p> <p><b>Terminal giratorio</b></p>
	<p><b>Conexión instrumento:</b> KaVo® K700, KL700, KL701 y KL703</p> <p><b>Conexión equipo:</b> Abierta</p> <p><b>Garantía:</b> 6 meses</p> <p><b>Ref.:</b> <b>40-51N1206</b>      <b>148<sup>00</sup>€</b></p>	<p><b>Longitud:</b> 190cm</p> <p><b>Color:</b> Gris claro (RAL 9002)</p>
	<p><b>Conexión instrumento:</b> KaVo® K700, KL700, KL701 y KL703</p> <p><b>Conexión equipo:</b> Abierta</p> <p><b>Origen:</b> Italia      <b>Fabricante:</b> Tekne Dental (TKD®)      <b>Garantía:</b> 12 meses</p> <p><b>Ref.:</b> <b>40-51B1202</b>      <b>218<sup>00</sup>€</b></p>	<p><b>Longitud:</b> 200cm</p> <p><b>Color:</b> Gris claro (RAL 9002)</p> <p><b>Regulación de spray</b></p>

HASTA AGOTAR

## Mangueras para Micromotores KaVo®: Conector a equipo KaVo®

RUMAR



### Mangueras para Micromotores KaVo®: Conector a equipo KaVo®

### Características

	<p><b>Conexión instrumento:</b> KaVo® K190, K196 y K200 + Chirana® Medical CH660 L</p> <p><b>Conexión equipo:</b> KaVo® 1057 y 1060</p> <p><b>Origen:</b> Italia      <b>Fabricante:</b> Tekne Dental (TKD®)      <b>Garantía:</b> 12 meses</p> <p><b>Ref.:</b> <b>40-52G6201</b>      <b>218<sup>00</sup>€</b></p>	<p><b>Longitud:</b> 120cm</p> <p><b>Color:</b> Gris medio (RAL 7035)</p> <p><b>Terminal giratorio</b></p>
	<p><b>Conexión instrumento:</b> KaVo® K190, K196 y K200 + Chirana® Medical CH660 L</p> <p><b>Conexión equipo:</b> KaVo® 1057 y 1060</p> <p><b>Origen:</b> Italia      <b>Fabricante:</b> Tekne Dental (TKD®)      <b>Garantía:</b> 12 meses</p> <p><b>Ref.:</b> <b>40-52E6201</b>      <b>218<sup>00</sup>€</b></p>	<p><b>Longitud:</b> 135cm</p> <p><b>Color:</b> Gris medio (RAL 7035)</p> <p><b>Terminal giratorio</b></p>
	<p><b>Conexión instrumento:</b> KaVo® K190, K196 y K200 + Chirana® Medical CH660 L</p> <p><b>Conexión equipo:</b> KaVo® 1057 y 1060</p> <p><b>Origen:</b> Italia      <b>Fabricante:</b> Tekne Dental (TKD®)      <b>Garantía:</b> 12 meses</p> <p><b>Ref.:</b> <b>40-52G6211</b>      <b>318<sup>00</sup>€</b></p>	<p><b>Longitud:</b> 120cm</p> <p><b>Color:</b> Gris medio (RAL 7035)</p> <p><b>Regulación de spray</b></p>
	<p><b>Conexión instrumento:</b> KaVo® K190, K196 y K200 + Chirana® Medical CH660 L</p> <p><b>Conexión equipo:</b> KaVo® 1057 y 1060</p> <p><b>Origen:</b> Italia      <b>Fabricante:</b> Tekne Dental (TKD®)      <b>Garantía:</b> 12 meses</p> <p><b>Ref.:</b> <b>40-52E6211</b>      <b>324<sup>80</sup>€</b></p>	<p><b>Longitud:</b> 135cm</p> <p><b>Color:</b> Gris medio (RAL 7035)</p> <p><b>Regulación de spray</b></p>

BAJO PEDIDO

BAJO PEDIDO

SI NO ENCUENTRAS EL REPUESTO QUE BUSCAS, ¡CONSÚLTANOS!  
Precios: impuestos, portes y mano de obra no incluidos.





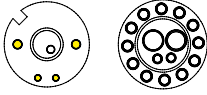
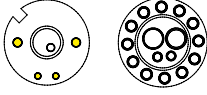
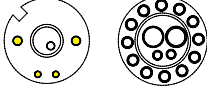
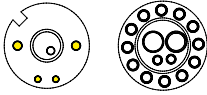
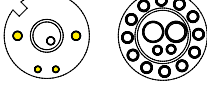
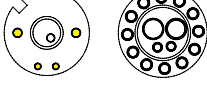
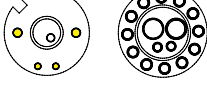
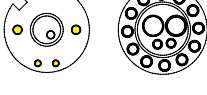
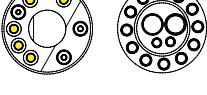
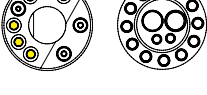















**Mangueras para Micromotores KaVo®: Conector a equipo KaVo®**



**Características**

	<p><b>Conexión instrumento:</b> KaVo® K190, K196 y K200 + Chirana® Medical CH660 L  <b>Conexión equipo:</b> KaVo® 1057, 1058*, 1060, 1062, 1063, 1065, 1066, 1078, 1080 (*Excepto 1058 Primus Life) (Serie 1)</p> <p><b>Origen:</b> Italia      <b>Fabricante:</b> Tekne Dental (TKD®)      <b>Garantía:</b> 12 meses</p> <p><b>Ref.:</b> <b>40-52G6221</b>      <b>208<sup>00</sup>€</b></p>	<p><b>Longitud:</b> 120cm  <b>Color:</b> Gris medio (RAL 7035)  <b>Terminal giratorio</b></p> <p><b>BAJO PEDIDO</b></p>
	<p><b>Conexión instrumento:</b> KaVo® K190, K196 y K200 + Chirana® Medical CH660 L  <b>Conexión equipo:</b> KaVo® 1057, 1058*, 1060, 1062, 1063, 1065, 1066, 1078, 1080 (*Excepto 1058 Primus Life) (Serie 1)</p> <p><b>Origen:</b> Italia      <b>Fabricante:</b> Tekne Dental (TKD®)      <b>Garantía:</b> 12 meses</p> <p><b>Ref.:</b> <b>40-52E6221</b>      <b>214<sup>80</sup>€</b></p>	<p><b>Longitud:</b> 135cm  <b>Color:</b> Gris medio (RAL 7035)  <b>Terminal giratorio</b></p>
	<p><b>Conexión instrumento:</b> KaVo® K190, K196 y K200 + Chirana® Medical CH660 L  <b>Conexión equipo:</b> KaVo® 1057, 1058*, 1060, 1062, 1063, 1065, 1066, 1078, 1080 (*Excepto 1058 Primus Life) (Serie 1)</p> <p><b>Origen:</b> Italia      <b>Fabricante:</b> Tekne Dental (TKD®)      <b>Garantía:</b> 12 meses</p> <p><b>Ref.:</b> <b>40-52G6231</b>      <b>350<sup>80</sup>€</b></p>	<p><b>Longitud:</b> 120cm  <b>Color:</b> Gris medio (RAL 7035)  <b>Regulación de spray</b></p> <p><b>BAJO PEDIDO</b></p>
	<p><b>Conexión instrumento:</b> KaVo® K190, K196 y K200 + Chirana® Medical CH660 L  <b>Conexión equipo:</b> KaVo® 1057, 1058*, 1060, 1062, 1063, 1065, 1066, 1078, 1080 (*Excepto 1058 Primus Life) (Serie 1)</p> <p><b>Origen:</b> Italia      <b>Fabricante:</b> Tekne Dental (TKD®)      <b>Garantía:</b> 12 meses</p> <p><b>Ref.:</b> <b>40-52E6231</b>      <b>350<sup>80</sup>€</b></p>	<p><b>Longitud:</b> 135cm  <b>Color:</b> Gris medio (RAL 7035)  <b>Regulación de spray</b></p> <p><b>BAJO PEDIDO</b></p>
	<p><b>Conexión instrumento:</b> KaVo® K190, K196 y K200 + Chirana® Medical CH660 L  <b>Conexión equipo:</b> KaVo® E30S, E30T, E50S, Y E70S, excepto: E50T, E70T y E80T (Serie 2: sin sensor magnético)</p> <p><b>Origen:</b> Italia      <b>Fabricante:</b> Tekne Dental (TKD®)      <b>Garantía:</b> 12 meses</p> <p><b>Ref.:</b> <b>40-52G6241</b>      <b>219<sup>80</sup>€</b></p>	<p><b>Longitud:</b> 120cm  <b>Color:</b> Gris medio (RAL 7035)  <b>Terminal giratorio</b></p> <p><b>BAJO PEDIDO</b></p>
	<p><b>Conexión instrumento:</b> KaVo® K190, K196 y K200 + Chirana® Medical CH660 L  <b>Conexión equipo:</b> KaVo® E30S, E30T, E50S, Y E70S, excepto: E50T, E70T y E80T (Serie 2: sin sensor magnético)</p> <p><b>Origen:</b> Italia      <b>Fabricante:</b> Tekne Dental (TKD®)      <b>Garantía:</b> 12 meses</p> <p><b>Ref.:</b> <b>40-52E6241</b>      <b>225<sup>80</sup>€</b></p>	<p><b>Longitud:</b> 135cm  <b>Color:</b> Gris medio (RAL 7035)  <b>Terminal giratorio</b></p> <p><b>BAJO PEDIDO</b></p>
	<p><b>Conexión instrumento:</b> KaVo® K190, K196 y K200 + Chirana® Medical CH660 L  <b>Conexión equipo:</b> KaVo® E30S, E30T, E50S, Y E70S, excepto: E50T, E70T y E80T (Serie 2: sin sensor magnético)</p> <p><b>Origen:</b> Italia      <b>Fabricante:</b> Tekne Dental (TKD®)      <b>Garantía:</b> 12 meses</p> <p><b>Ref.:</b> <b>40-52G6251</b>      <b>304<sup>80</sup>€</b></p>	<p><b>Longitud:</b> 120cm  <b>Color:</b> Gris medio (RAL 7035)  <b>Regulación de spray</b></p> <p><b>BAJO PEDIDO</b></p>
	<p><b>Conexión instrumento:</b> KaVo® K190, K196 y K200 + Chirana® Medical CH660 L  <b>Conexión equipo:</b> KaVo® E30S, E30T, E50S, Y E70S, excepto: E50T, E70T y E80T (Serie 2: sin sensor magnético)</p> <p><b>Origen:</b> Italia      <b>Fabricante:</b> Tekne Dental (TKD®)      <b>Garantía:</b> 12 meses</p> <p><b>Ref.:</b> <b>40-52E6251</b>      <b>309<sup>80</sup>€</b></p>	<p><b>Longitud:</b> 135cm  <b>Color:</b> Gris medio (RAL 7035)  <b>Regulación de spray</b></p> <p><b>BAJO PEDIDO</b></p>
	<p><b>Conexión instrumento:</b> KaVo® K700, KL700, KL701 y KL703  <b>Conexión equipo:</b> KaVo® 1057 y 1060</p> <p><b>Origen:</b> Italia      <b>Fabricante:</b> Tekne Dental (TKD®)      <b>Garantía:</b> 12 meses</p> <p><b>Ref.:</b> <b>40-52G6330</b>      <b>321<sup>80</sup>€</b></p>	<p><b>Longitud:</b> 120cm  <b>Color:</b> Gris medio (RAL 7035)</p> <p><b>BAJO PEDIDO</b></p>
	<p><b>Conexión instrumento:</b> KaVo® K700, KL700, KL701 y KL703  <b>Conexión equipo:</b> KaVo® 1057 y 1060</p> <p><b>Origen:</b> Italia      <b>Fabricante:</b> Tekne Dental (TKD®)      <b>Garantía:</b> 12 meses</p> <p><b>Ref.:</b> <b>40-52E6330</b>      <b>326<sup>80</sup>€</b></p>	<p><b>Longitud:</b> 135cm  <b>Color:</b> Gris medio (RAL 7035)</p> <p><b>BAJO PEDIDO</b></p>

## Mangueras para Micromotores KaVo®: Conector a equipo KaVo®







## Características

		<p><b>Conexión instrumento:</b> KaVo® K700, KL700, KL701 y KL703</p> <p><b>Conexión equipo:</b> KaVo® 1057, 1058*, 1060, 1062, 1063, 1065, 1066, 1078, 1080 (*Excepto 1058 Primus Life) (Serie 1)</p> <p><b>Origen:</b> Italia      <b>Fabricante:</b> Tekne Dental (TKD®)      <b>Garantía:</b> 12 meses</p> <p><b>Ref.:</b> <b>40-52G6300</b>      <b>211<sup>80</sup>€</b></p>	<p><b>Longitud:</b> 120cm</p> <p><b>Color:</b> Gris medio (RAL 7035)</p> <p><b>BAJO PEDIDO</b></p>
		<p><b>Conexión instrumento:</b> KaVo® K700, KL700, KL701 y KL703</p> <p><b>Conexión equipo:</b> KaVo® 1057, 1058*, 1060, 1062, 1063, 1065, 1066, 1078, 1080 (*Excepto 1058 Primus Life) (Serie 1)</p> <p><b>Origen:</b> Italia      <b>Fabricante:</b> Tekne Dental (TKD®)      <b>Garantía:</b> 12 meses</p> <p><b>Ref.:</b> <b>40-52E6300</b>      <b>216<sup>80</sup>€</b></p>	<p><b>Longitud:</b> 135cm</p> <p><b>Color:</b> Gris medio (RAL 7035)</p>
		<p><b>Conexión instrumento:</b> KaVo® K700, KL700, KL701 y KL703</p> <p><b>Conexión equipo:</b> KaVo® 1057, 1058*, 1060, 1062, 1063, 1065, 1066, 1078, 1080 (*Excepto 1058 Primus Life) (Serie 1)</p> <p><b>Origen:</b> Italia      <b>Fabricante:</b> Tekne Dental (TKD®)      <b>Garantía:</b> 12 meses</p> <p><b>Ref.:</b> <b>40-52G6301</b>      <b>375<sup>80</sup>€</b></p>	<p><b>Longitud:</b> 120cm</p> <p><b>Color:</b> Gris medio (RAL 7035)</p> <p><b>Regulación de spray</b></p> <p><b>BAJO PEDIDO</b></p>
		<p><b>Conexión instrumento:</b> KaVo® K700, KL700, KL701 y KL703</p> <p><b>Conexión equipo:</b> KaVo® 1057, 1058*, 1060, 1062, 1063, 1065, 1066, 1078, 1080 (*Excepto 1058 Primus Life) (Serie 1)</p> <p><b>Origen:</b> Italia      <b>Fabricante:</b> Tekne Dental (TKD®)      <b>Garantía:</b> 12 meses</p> <p><b>Ref.:</b> <b>40-52E6301</b>      <b>381<sup>80</sup>€</b></p>	<p><b>Longitud:</b> 135cm</p> <p><b>Color:</b> Gris medio (RAL 7035)</p> <p><b>Regulación de spray</b></p> <p><b>BAJO PEDIDO</b></p>
		<p><b>Conexión instrumento:</b> KaVo® K700, KL700, KL701 y KL703</p> <p><b>Conexión equipo:</b> KaVo® E30S, E30T, E50S y E70S, excepto E50T, E70T y E80T (Serie 2: sin sensor magnético)</p> <p><b>Origen:</b> Italia      <b>Fabricante:</b> Tekne Dental (TKD®)      <b>Garantía:</b> 12 meses</p> <p><b>Ref.:</b> <b>40-52G6310</b>      <b>222<sup>80</sup>€</b></p>	<p><b>Longitud:</b> 120cm</p> <p><b>Color:</b> Gris medio (RAL 7035)</p> <p><b>BAJO PEDIDO</b></p>
		<p><b>Conexión instrumento:</b> KaVo® K700, KL700, KL701 y KL703</p> <p><b>Conexión equipo:</b> KaVo® E30S, E30T, E50S y E70S, excepto E50T, E70T y E80T (Serie 2: sin sensor magnético)</p> <p><b>Origen:</b> Italia      <b>Fabricante:</b> Tekne Dental (TKD®)      <b>Garantía:</b> 12 meses</p> <p><b>Ref.:</b> <b>40-52E6310</b>      <b>228<sup>00</sup>€</b></p>	<p><b>Longitud:</b> 135cm</p> <p><b>Color:</b> Gris medio (RAL 7035)</p> <p><b>BAJO PEDIDO</b></p>
		<p><b>Conexión instrumento:</b> KaVo® K700, KL700, KL701 y KL703</p> <p><b>Conexión equipo:</b> KaVo® E30S, E30T, E50S y E70S, excepto E50T, E70T y E80T (Serie 2: sin sensor magnético)</p> <p><b>Origen:</b> Italia      <b>Fabricante:</b> Tekne Dental (TKD®)      <b>Garantía:</b> 12 meses</p> <p><b>Ref.:</b> <b>40-52G6311</b>      <b>308<sup>00</sup>€</b></p>	<p><b>Longitud:</b> 120cm</p> <p><b>Color:</b> Gris medio (RAL 7035)</p> <p><b>Regulación de spray</b></p> <p><b>BAJO PEDIDO</b></p>
		<p><b>Conexión instrumento:</b> KaVo® K700, KL700, KL701 y KL703</p> <p><b>Conexión equipo:</b> KaVo® E30S, E30T, E50S y E70S, excepto E50T, E70T y E80T (Serie 2: sin sensor magnético)</p> <p><b>Origen:</b> Italia      <b>Fabricante:</b> Tekne Dental (TKD®)      <b>Garantía:</b> 12 meses</p> <p><b>Ref.:</b> <b>40-52E6311</b>      <b>318<sup>00</sup>€</b></p>	<p><b>Longitud:</b> 135cm</p> <p><b>Color:</b> Gris medio (RAL 7035)</p> <p><b>Regulación de spray</b></p>
		<p><b>Conexión instrumento:</b> KaVo® K700, KL700, KL701 y KL703</p> <p><b>Conexión equipo:</b> KaVo® E50T, E70T, E80T y Kavo® 1058 Life + (Serie 3) (Con sensor magnético y con resistencia)</p> <p><b>Origen:</b> Italia      <b>Fabricante:</b> Tekne Dental (TKD®)      <b>Garantía:</b> 12 meses</p> <p><b>Ref.:</b> <b>40-52G6320</b>      <b>238<sup>00</sup>€</b></p>	<p><b>Longitud:</b> 120cm</p> <p><b>Color:</b> Gris medio (RAL 7035)</p> <p><b>BAJO PEDIDO</b></p>
		<p><b>Conexión instrumento:</b> KaVo® K700, KL700, KL701 y KL703</p> <p><b>Conexión equipo:</b> KaVo® E50T, E70T, E80T y Kavo® 1058 Life + (Serie 3) (Con sensor magnético y con resistencia)</p> <p><b>Origen:</b> Italia      <b>Fabricante:</b> Tekne Dental (TKD®)      <b>Garantía:</b> 12 meses</p> <p><b>Ref.:</b> <b>40-52E6320</b>      <b>242<sup>80</sup>€</b></p>	<p><b>Longitud:</b> 135cm</p> <p><b>Color:</b> Gris medio (RAL 7035)</p> <p><b>BAJO PEDIDO</b></p>

Mangueras para Micromotores KaVo®: Conector a equipo KaVo®		Características
 	<p><b>Conexión instrumento:</b> KaVo® K700, KL700, KL701 y KL703  <b>Conexión equipo:</b> KaVo® E50T, E70T, E80T y KaVo® 1058 Life + (Serie 3) (Con sensor magnético y con resistencia)</p> <p>Origen: Italia      Fabricante: Tekne Dental (TKD®)      Garantía: 12 meses</p> <p><b>Ref.: 40-52G6321</b> <span style="float: right;"><b>353<sup>80</sup>€</b></span></p>	<p><b>Longitud:</b> 120cm  <b>Color:</b> Gris medio (RAL 7035)  <b>Regulación de spray</b></p> <p style="text-align: right;"><b>BAJO PEDIDO</b></p>
	<p><b>Conexión instrumento:</b> KaVo® K700, KL700, KL701 y KL703  <b>Conexión equipo:</b> KaVo® E50T, E70T, E80T y KaVo® 1058 Life + (Serie 3) (Con sensor magnético y con resistencia)</p> <p>Origen: Italia      Fabricante: Tekne Dental (TKD®)      Garantía: 12 meses</p> <p><b>Ref.: 40-52E6321</b> <span style="float: right;"><b>358<sup>00</sup>€</b></span></p>	<p><b>Longitud:</b> 135cm  <b>Color:</b> Gris medio (RAL 7035)  <b>Regulación de spray</b></p> <p style="text-align: right;"><b>BAJO PEDIDO</b></p>

**Mangueras para Micromotores KaVo®: Conector a equipo Planmeca®**



Mangueras para Micromotores KaVo®: Conector a equipo Planmeca®		Características
 	<p><b>Conexión instrumento:</b> KaVo® K190, K196 y K200 y Chirana® Medical CH660, con luz  <b>Conexión equipo:</b> Planmeca®</p> <p>Origen: Italia      Fabricante: Tekne Dental (TKD®)      Garantía: 12 meses</p> <p><b>Ref.: 40-52M1201</b> (Ref. Planmeca®: J10007954-4) <span style="float: right;"><b>198<sup>00</sup>€</b></span></p>	<p><b>Longitud:</b> 101cm  <b>Color:</b> Gris claro (RAL 9002)  <b>Resistencia:</b> 270 Ohm</p>
	<p><b>Conexión instrumento:</b> KaVo® K190, K196 y K200 y Chirana® Medical CH660, con luz  <b>Conexión equipo:</b> Planmeca®</p> <p>Origen: Italia      Fabricante: Tekne Dental (TKD®)      Garantía: 12 meses</p> <p><b>Ref.: 40-52M1204</b> (Ref. Planmeca®: J10007954-4) <span style="float: right;"><b>268<sup>00</sup>€</b></span></p>	<p><b>Longitud:</b> 101cm  <b>Color:</b> Gris claro (RAL 9002)  <b>Terminal giratorio:</b> 400°  <b>Resistencia:</b> 270 Ohm</p> <p style="text-align: right;"><b>BAJO PEDIDO</b></p>
 	<p><b>Conexión instrumento:</b> KaVo® K190, K196 y K200 y Chirana® Medical CH660, con luz  <b>Conexión equipo:</b> Planmeca®</p> <p>Origen: Italia      Fabricante: Tekne Dental (TKD®)      Garantía: 12 meses</p> <p><b>Ref.: 40-52M1202</b> <span style="float: right;"><b>226<sup>80</sup>€</b></span></p>	<p><b>Longitud:</b> 101cm  <b>Color:</b> Gris claro (RAL 9002)  <b>Sin resistencia</b></p> <p style="text-align: right;"><b>BAJO PEDIDO</b></p>
	<p><b>Conexión instrumento:</b> KaVo® K190, K196 y K200 y Chirana® Medical CH660, con luz  <b>Conexión equipo:</b> Planmeca®</p> <p>Origen: Italia      Fabricante: Tekne Dental (TKD®)      Garantía: 12 meses</p> <p><b>Ref.: 40-52M1207</b> <span style="float: right;"><b>255<sup>80</sup>€</b></span></p>	<p><b>Longitud:</b> 101cm  <b>Color:</b> Gris claro (RAL 9002)  <b>Terminal giratorio:</b> 400°  <b>Sin resistencia</b></p> <p style="text-align: right;"><b>BAJO PEDIDO</b></p>
 	<p><b>Conexión instrumento:</b> KaVo® K190, K196 y K200, con luz  <b>Conexión equipo:</b> Planmeca®</p> <p>Garantía: 6 meses</p> <p><b>Ref.: 40-52M1203</b> <span style="float: right;"><b>282<sup>80</sup>€</b></span></p>	<p><b>Longitud:</b> 101cm  <b>Color:</b> Gris claro (RAL 9002)  <b>Terminal giratorio:</b> 400°  <b>Resistencia:</b> 270 Ohm  <b>(Especial Kart)</b></p> <p style="text-align: right;"><b>HASTA AGOTAR</b></p>

**PARA EQUIPOS SWIDENT® U OMS® CONTACTE CON NOSOTROS**

## Mangueras para Micromotores KaVo®: Conector a equipo Sirona®

RUMAR



## Mangueras para Micromotores KaVo®: Conector a equipo Sirona®

## Características

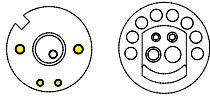

**Conexión instrumento:** KaVo® K190, K196 y K200 + Chirana® Medical CH660 L  
**Conexión equipo:** A1, A2, A4, A5, AC, C1, C1+, C2, C2+, C4, C4+, C5+, C8, C8+, E1, E2, E4, EC, M1, M1+, PROFEEL, SPIRIT, S1, S2.

**Origen:** Italia **Fabricante:** Tekne Dental (TKD®) **Garantía:** 12 meses

**Ref.:** 40-52L1201

219<sup>80</sup>€

BAJO PEDIDO

**Longitud:** 137cm  
**Color:** Gris claro (RAL 9002)

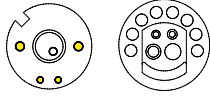

**Conexión instrumento:** KaVo® K190, K196 y K200 + Chirana® Medical CH660 L  
**Conexión equipo:** A1, A2, A4, A5, AC, C1, C1+, C2, C2+, C4, C4+, C5+, C8, C8+, E1, E2, E4, EC, M1, M1+, PROFEEL, SPIRIT, S1, S2.

**Origen:** Italia **Fabricante:** Tekne Dental (TKD®) **Garantía:** 12 meses

**Ref.:** 40-52L1202

249<sup>80</sup>€

BAJO PEDIDO

**Longitud:** 137cm  
**Color:** Gris claro (RAL 9002)  
**Terminal giratorio**

## Mangueras para Micromotores NSK®

Conexión a equipo: **Abierta / Open end** **Cefla®** **KaVo®** **Planmeca®** **Sirona®**

## Mangueras para Micromotores NSK®: Conexión Abierta / Open End

RUMAR



## Mangueras para Micromotores NSK®: Conexión Abierta / Open End

## Características



**Conexión instrumento:** Micromotor NSK® M40  
**Conexión equipo:** Abierta

**Origen:** Italia **Fabricante:** Tekne Dental (TKD®) **Garantía:** 12 meses

**Ref.:** 40-51A1003

94<sup>80</sup>€

**Longitud:** 160cm  
**Color:** Gris claro (RAL 9002)



**Conexión instrumento:** Micromotor NSK® M40  
**Conexión equipo:** Abierta

**Origen:** Italia **Fabricante:** Tekne Dental (TKD®) **Garantía:** 12 meses

**Ref.:** 40-51A2003

94<sup>80</sup>€

**Longitud:** 160cm  
**Color:** Gris oscuro (RAL 7038)



**Conexión instrumento:** Micromotor NSK® M40\*  
**Conexión equipo:** Abierta

**Origen:** Italia **Fabricante:** Tekne Dental (TKD®) **Garantía:** 12 meses

**Ref.:** 40-51A2004

198<sup>00</sup>€

**Longitud:** 160cm  
**Color:** Gris oscuro (RAL 7038)  
**Regulación de spray**  
 \*Necesario adaptador 40-006

BAJO PEDIDO



**Conexión instrumento:** Micromotor NSK® M40\*  
**Conexión equipo:** Abierta

**Origen:** Italia **Fabricante:** Tekne Dental (TKD®) **Garantía:** 12 meses

**Ref.:** 40-51A2009

118<sup>00</sup>€

**Longitud:** 160cm  
**Color:** Gris oscuro (RAL 7038)  
**Terminal giratorio**  
 \*Necesario adaptador 40-006

BAJO PEDIDO

Mangueras para Micromotores NSK®: **Conexión Cefla®**

RUMAR

Mangueras para Micromotores NSK®: **Conexión Cefla®**

## Características

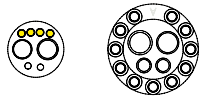

**Conexión instrumento:** NSK M40 + turbina, **polivalente** con y sin luz  
**Conexión equipo Cefla® (desde 2006):**  
**Anthos®:** A3, A5, A6, A7, A9, L6, L9, R7; **Stern Weber®:** S200, S220TR S250, S280TRC, S300, 320TR, S320TR, S380TRC;  
**Castellini®:** SKEMA 5, SKEMA 6, SKEMA 8, PUMA ELI

**Origen:** Italia **Fabricante:** Tekne Dental (TKD®) **Garantía:** 12 meses

Ref.: **40-52E2003****184<sup>80</sup>€**

BAJO PEDIDO

**Longitud:** 135cm  
**Color:** Gris oscuro (RAL 7038)

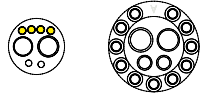

**Conexión instrumento:** NSK M40 + turbina, **polivalente** con y sin luz  
**Conexión equipo Cefla® (desde 2006):**  
**Anthos®:** A3, A5, A6, A7, A9, L6, L9, R7; **Stern Weber®:** S200, S220TR S250, S280TRC, S300, 320TR, S320TR, S380TRC;  
**Castellini®:** SKEMA 5, SKEMA 6, SKEMA 8, PUMA ELI

**Origen:** Italia **Fabricante:** Tekne Dental (TKD®) **Garantía:** 12 meses

Ref.: **40-52G2003****196<sup>80</sup>€**

**Longitud:** 120cm  
**Color:** Gris oscuro (RAL 7038)

Mangueras para Micromotores NSK®: **Conexión Planmeca®**

RUMAR

Mangueras para Micromotores NSK®: **Conexión Planmeca®**

## Características

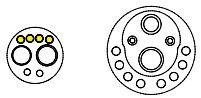

**Conexión instrumento:** NSK M40 + Turbina, **Polivalente**  
**Conexión equipo:** Planmeca®

**Origen:** Italia **Fabricante:** Tekne Dental (TKD®) **Garantía:** 12 meses

Ref.: **40-52M1003** (Ref. Planmeca®: J10044909-1)**238<sup>00</sup>€**

BAJO PEDIDO

**Longitud:** 98cm  
**Color:** Gris claro (RAL9002)  
**Resistencia:** 82 Ohm

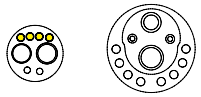

**Conexión instrumento:** NSK M40 + Turbina, **Polivalente**  
**Conexión equipo:** Planmeca®

**Origen:** Italia **Fabricante:** Tekne Dental (TKD®) **Garantía:** 12 meses

Ref.: **40-52K1003****238<sup>00</sup>€**

BAJO PEDIDO

**Longitud:** 90cm  
**Color:** Gris claro (RAL 9002)  
**Resistencia:** 82 Ohm

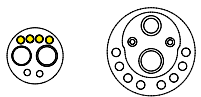

**Conexión instrumento:** NSK M40 + Turbina, **Polivalente**  
**Conexión equipo:** Planmeca®

**Origen:** Italia **Fabricante:** Tekne Dental (TKD®) **Garantía:** 12 meses

Ref.: **40-52D1003****230<sup>80</sup>€**

BAJO PEDIDO

**Longitud:** 150cm  
**Color:** Gris claro (RAL 9002)  
**Resistencia:** 82 Ohm

Mangueras para Micromotores NSK®: **Conexión Sirona®**

RUMAR

Mangueras para Micromotores NSK®: **Conexión Planmeca®**

## Características

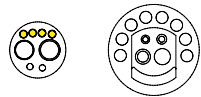

**Conexión instrumento:** NSK® M40  
**Conexión equipo:** M1, C6 y E3, M1+, M196, C3, C3+.

**Origen:** Italia **Fabricante:** Tekne Dental (TKD®) **Garantía:** 12 meses

Ref.: **40-52L1005****268<sup>00</sup>€**

**Longitud:** 137cm  
**Color:** Gris claro (RAL 9002)  
**Terminal giratorio:** 400°

PARA EL RESTO DE MANGUERAS VER SECCIÓN MANGUERAS MICROMOTORES BIEN AIR®

# Mangueras para Micromotores Sirona®

Conexión a equipo: **Abierta / Open end** Cefla® KaVo® Planmeca® Sirona®

## Mangueras para Micromotores Sirona®: Conexión Abierta / Open End

RUMAR 

	Mangueras para Micromotores Sirona®: Conexión Abierta / Open End	Características
	<p><b>Conexión instrumento:</b> Micromotor Sirona® BL ISO C con luz (Conector micromotor verde)</p> <p><b>Conexión equipo:</b> Abierta</p> <p><b>Origen:</b> Italia      <b>Fabricante:</b> Tekne Dental (TKD®)      <b>Garantía:</b> 12 meses</p> <p><b>Ref.:</b> <b>40-51A1401</b>      <b>178<sup>00</sup>€</b></p>	<p><b>Longitud:</b> 160cm</p> <p><b>Color:</b> Gris claro (RAL 9002)</p> <p><b>BAJO PEDIDO</b></p>
	<p><b>Conexión instrumento:</b> Micromotor Sirona® BL con luz (Conector micromotor azul)</p> <p><b>Conexión equipo:</b> Abierta</p> <p><b>Origen:</b> Italia      <b>Fabricante:</b> Tekne Dental (TKD®)      <b>Garantía:</b> 12 meses</p> <p><b>Ref.:</b> <b>40-51A1402</b>      <b>178<sup>00</sup>€</b></p>	<p><b>Longitud:</b> 160cm</p> <p><b>Color:</b> Gris claro (RAL 9002)</p> <p><b>BAJO PEDIDO</b></p>
	<p><b>Conexión instrumento:</b> Micromotor Sirona® BL ISO con luz (Conector micromotor negro)</p> <p><b>Conexión equipo:</b> Abierta</p> <p><b>Origen:</b> Italia      <b>Fabricante:</b> Tekne Dental (TKD®)      <b>Garantía:</b> 12 meses</p> <p><b>Ref.:</b> <b>40-51A1403</b>      <b>178<sup>00</sup>€</b></p>	<p><b>Longitud:</b> 160cm</p> <p><b>Color:</b> Gris claro (RAL 9002)</p> <p><b>BAJO PEDIDO</b></p>

## Mangueras para Micromotores Sirona®: Conector a equipo Sirona®

RUMAR 

	Mangueras para Micromotores Sirona®: Conector a equipo Sirona®	Características
 	<p><b>Conexión instrumento:</b> Sirona® BL (Conector azul)</p> <p><b>Conexión equipo:</b> Sirona® Teneo y Sinius</p> <p><b>Origen:</b> Italia      <b>Fabricante:</b> Tekne Dental (TKD®)      <b>Garantía:</b> 12 meses</p> <p><b>Ref.:</b> <b>40-52F1401</b> (Ref. Sirona®: 6383118)      <b>282<sup>80</sup>€</b></p>	<p>*Medición apical no disponible</p> <p><b>Longitud:</b> 135cm</p> <p><b>Color:</b> Gris claro (RAL 9002)</p> <p><b>Terminal giratorio:</b> 540°</p> <p><b>BAJO PEDIDO</b></p>
 	<p><b>Conexión instrumento:</b> Sirona® BL ISO (Conector negro)</p> <p><b>Conexión equipo:</b> Sirona® Teneo</p> <p><b>Origen:</b> Italia      <b>Fabricante:</b> Tekne Dental (TKD®)      <b>Garantía:</b> 12 meses</p> <p><b>Ref.:</b> <b>40-52F1402</b> (Ref. Sirona®: 6336860)      <b>282<sup>80</sup>€</b></p>	<p>*Medición apical no disponible</p> <p><b>Longitud:</b> 135cm</p> <p><b>Color:</b> Gris claro (RAL 9002)</p> <p><b>Terminal giratorio:</b> 540°</p> <p><b>BAJO PEDIDO</b></p>
 	<p><b>Conexión instrumento:</b> Sirona® BL ISO C (Conector verde)</p> <p><b>Conexión equipo:</b> Sirona® Teneo, Sinius Intego e Intego Pro</p> <p><b>Origen:</b> Italia      <b>Fabricante:</b> Tekne Dental (TKD®)      <b>Garantía:</b> 12 meses</p> <p><b>Ref.:</b> <b>40-52F1403</b> (Ref. Sirona®: 6336700)      <b>279<sup>80</sup>€</b></p>	<p>*Medición apical no disponible</p> <p><b>Longitud:</b> 135cm</p> <p><b>Color:</b> Gris claro (RAL 9002)</p> <p><b>Terminal giratorio:</b> 540°</p> <p><b>BAJO PEDIDO</b></p>

## MANGUERAS PARA JERINGAS

Conexión a equipo: **Abierta / Open end** Cefla® KaVo® Planmeca® Sirona®

### Mangueras para Jeringas: Conexión Abierta / Open End

RUMAR 

#### Mangueras para jeringas: Conexión Abierta / Open End



**Conexión instrumento:** Manguera para jeringa, sin luz

**Conexión equipo:** Abierta

**Origen:** Italia

**Fabricante:** Tekne Dental (TKD®)

**Garantía:** 12 meses

**Ref.:** 40-61A2000

38'00€

#### Características

**Longitud:** 160cm

**Color:** Gris oscuro (RAL 7038)

### Mangueras para Jeringas: Conector a equipo KaVo®

RUMAR 

#### Mangueras para jeringas: Conector a equipo KaVo®

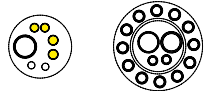

**Conexión instrumento:** Manguera para jeringas KaVo® 3F

**Conexión equipo:** KaVo® 1057, 1058\*, 1060, 1062, 1063, 1065, 1066, 1078, 1080 (\*Excepto 1058 Primus Life) (Serie 1)

**Origen:** Italia

**Fabricante:** Tekne Dental (TKD®)

**Garantía:** 12 meses

**Ref.:** 40-61G6000

118'00€

BAJO PEDIDO

#### Características

**Longitud:** 120cm

**Color:** Gris medio (RAL 7035)

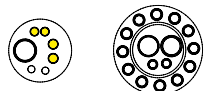

**Conexión instrumento:** Manguera para jeringas KaVo® 3F

**Conexión equipo:** KaVo® 1057, 1058\*, 1060, 1062, 1063, 1065, 1066, 1078, 1080 (\*Excepto 1058 Primus Life) (Serie 1)

**Origen:** Italia

**Fabricante:** Tekne Dental (TKD®)

**Garantía:** 12 meses

**Ref.:** 40-61E6000

124'80€

BAJO PEDIDO

**Longitud:** 135cm

**Color:** Gris medio (RAL 7035)

#### Para mangueras jeringas KaVo® 3F Y 4F con conectores a equipo KaVo®:

**Serie 1:** KaVo® 1057, 1058\*, 1060, 1062, 1063, 1065, 1066, 1078, 1080 (\*Excepto 1058 Primus Life) (Serie 1)

**Serie 2:** KaVo® E30S, E30T, E50S y E70S, excepto E50T, E70T y E80T (Serie 2: sin sensor magnético)

**Serie 3:** KaVo® E50T, E70T, E80T y KaVo® 1058 Life + (Serie 3) (Con sensor magnético y con resistencia)

CONSÚLTANOS

## MANGUERAS PARA LÁMPARAS FOTOCURADO

Conexión a equipo: **Abierta / Open end** Cefla® KaVo® Planmeca® Sirona®

### Mangueras para Lámparas Fotocurado: Conexión Abierta / Open End

RUMAR 

#### Mangueras para Lámparas Fotocurado: Conexión Abierta / Open End



**Conexión instrumento:** Lámpara TKD® Moon, compatible lámpara Castellini T-LED

**Conexión equipo:** Abierta

**Origen:** Italia

**Fabricante:** Tekne Dental (TKD®)

**Garantía:** 12 meses

**Ref.:** 40-91A2000

52'80€

#### Características

**Longitud:** 160cm

**Color:** Gris oscuro (RAL 7038)

## MANGUERAS PARA PEDALES

Conexión a equipo: Sin conectores

### Mangueras para pedales: Sin conectores

RUMAR



#### Mangueras para pedales: Sin conectores

#### Características



Manguera para pedales con control de agua y sin chip blower, 3 vías.

Sin conectores

Funda de silicona

Origen: Italia

Fabricante: Tekne Dental (TKD®)

Garantía: 12 meses

Ref.: 37-241

50'80€

HASTA AGOTAR

Longitud: 180cm

Color: Gris claro (RAL 9002)



Manguera para pedales con control de agua y chip blower, 4 tubos paralelos.

Sin conectores

Ref.: 44-850

14'80€/metro

Color: Gris oscuro (RAL 7035+)

Aséptico

**NO ADMITEN DEVOLUCIÓN**

Venta en múltiplos de 1 metro

## ACCESORIOS Y CONECTORES PARA MANGUERAS

### Accesorios y conectores: para mangueras

RUMAR



#### Descripción

#### Características



Casquillo metálico adaptador para mangueras MC2

Ref.: 40-010

12'80€



Casquillo metálico adaptador para convertir mangueras MC3 a turbina

Ref.: 40-006

15'80€



Kit conector manguera a unidades KaVo® (Serie 1)

Ref.: 40-020

53'80€

## RV ▶ REPUESTOS VARIOS

- Repuestos Micron® scaler SSS
- Repuestos pulidor bicarbonato Micron® Quick Jet
- Repuestos y accesorios ultrasonidos, micromotores y lámparas TKD®
- Repuestos lámparas quirófano Derungs®
- Repuestos Nouvag®
- Repuestos Woodpecker® y DTE®
- Repuestos lámparas fotocurado







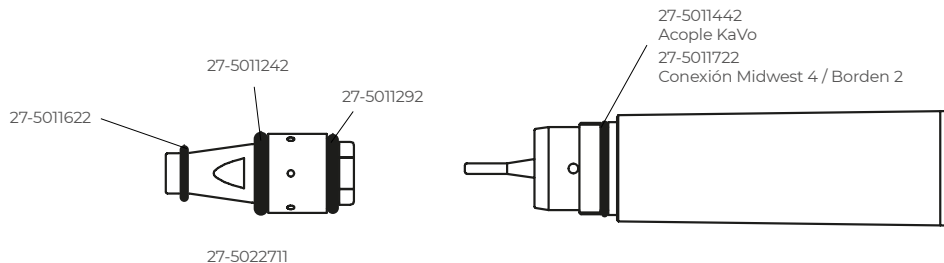

# REPUESTOS ULTRASONIDOS MICRON® SSS

Ultrasonidos Micron® SSS

MICRON®





	Descripción	Observaciones
	Cartucho cuerpo de oscilación  <b>Ref.: 27-5022711</b>	<b>348<sup>00</sup>€</b>
	Anillo tórico  <b>Ref.: 27-5011622</b>	<b>3<sup>80</sup>€</b>
	Anillo tórico  <b>Ref.: 27-5011242</b>	<b>3<sup>80</sup>€</b>
	Anillo tórico  <b>Ref.: 27-5011292</b>	<b>3<sup>80</sup>€</b>
	Anillo tórico (SSS acople KaVo®)  <b>Ref.: 27-5011442</b>	<b>3<sup>80</sup>€</b>
	Anillo tórico (SSS conexión Midwest 4 / Borden 2)  <b>Ref.: 27-5011722</b>	<b>3<sup>80</sup>€</b>

Las PUNTAS y LLAVES se consideran accesorios y se encuentran en el catálogo de APARATOLOGÍA

SI NO ENCUENTRAS EL REPUESTO QUE BUSCAS, ¡CONSÚLTANOS!  
Precios: impuestos, portes y mano de obra no incluidos.

## Pulidor bicarbonato ECO PULIMAX

	Descripción	Observaciones
	Punta pulidor ECO PULIMAX  <b>Ref.: 44-231</b>	<b>21<sup>80</sup>€</b>
	Kit 2 anillos tóricos conexión punta pulidor ECO PULIMAX  <b>Ref.: OR-232</b>	<b>1<sup>50</sup>€</b>

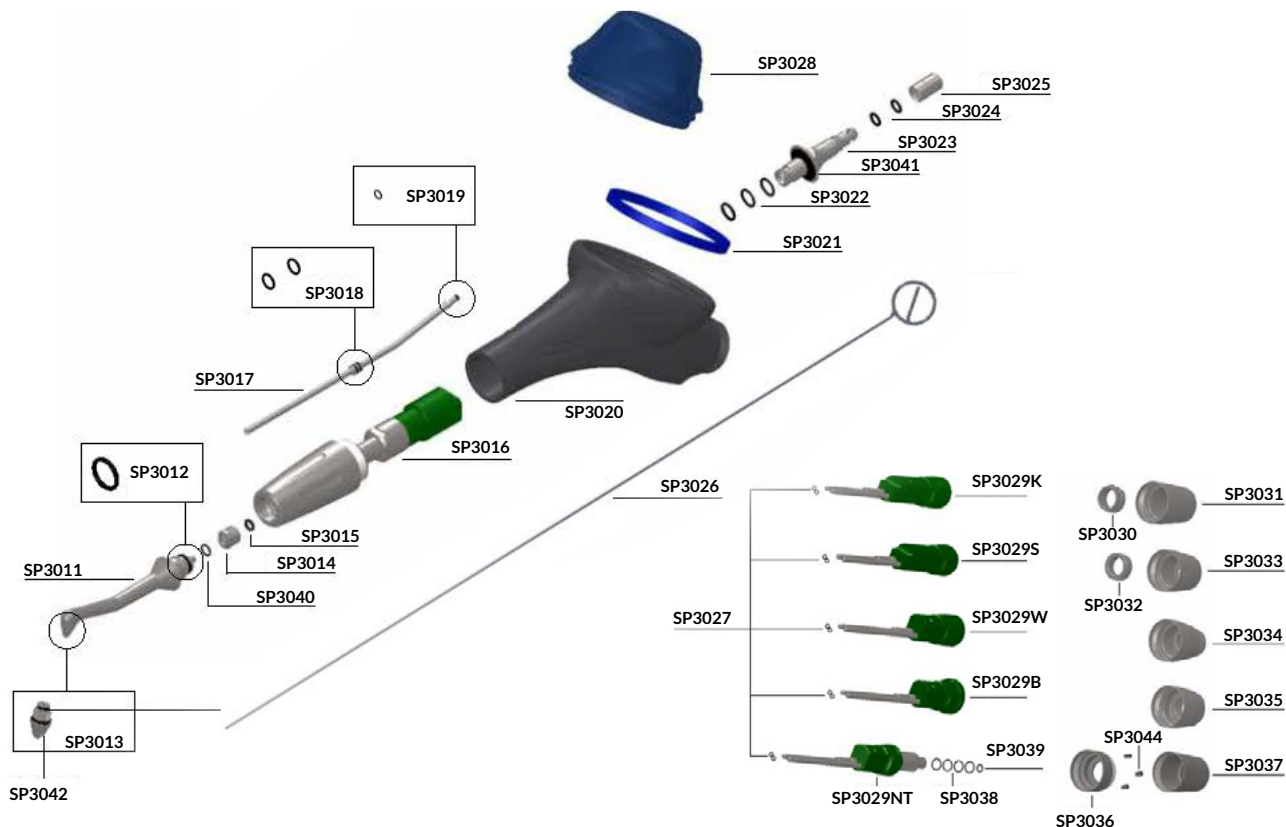

	Descripción	Observaciones
	Punta  Ref.: <b>APX-SP3011</b>	178 <sup>00</sup> €
	Anillo tórico  Ref.: <b>OR-SP3012</b>	2 <sup>80</sup> €
	Anillo tórico  Ref.: <b>OR-SP3015</b>	3 <sup>00</sup> €
	Anillo tórico  Ref.: <b>OR-SP3018</b>	2 <sup>80</sup> €
	Anillo tórico  Ref.: <b>OR-SP3019</b>	2 <sup>80</sup> €

	Descripción	Observaciones
	Junta sellado depósito bicarbonato  <b>Ref.: OR-SP3021</b>	<b>10'80€</b>
	Anillo tórico  <b>Ref.: OR-SP3022</b>	<b>2'80€</b>
	Anillo tórico  <b>Ref.: OR-SP3024</b>	<b>2'80€</b>
	Anillo tórico  <b>Ref.: OR-SP3027</b>	<b>2'80€</b>
	Anillo tórico  <b>Ref.: OR-SP3040</b>	<b>3'00€</b>
	Anillo tórico  <b>Ref.: OR-SP3041</b>	<b>3'00€</b>
	Anillo tórico  <b>Ref.: OR-SP3042</b>	<b>3'00€</b>
	Alambre de desatascó  <b>Ref.: HE-3026</b>	<b>7'00€</b>

## Scaler ECO S2



RUMAR

	Descripción	Observaciones
	<p>Cuerpo vibrador</p> <p>Ref.: SCX-ECOS2CV</p>	<p>Incluye: Anillos tóricos</p> <p>128<sup>00</sup>€</p>

## REPUESTOS LÁMPARAS DE QUIRÓFANO DERUNGS®



## Modelo Xerus

Derungs 

	Descripción	Observaciones
	<p>Asa central D99205000</p> <p>Ref.: 09-910</p>	<p>69<sup>30</sup>€</p>
	<p>Pantalla D99278000</p> <p>Ref.: 09-916</p>	<p>141<sup>60</sup>€</p>

## Modelo Iris / Isis 50

Derungs 

	Descripción	Observaciones
	<p>Bombilla D68615000</p> <p>Ref.: 09-920</p>	<p>26<sup>80</sup>€</p>
	<p>Asa central D55234000</p> <p>Ref.: 09-921</p>	<p>98<sup>30</sup>€</p>

## REPUESTOS NOUVAG®

### Implantología / Cirugía



**NOUVAG+**

	Descripción		Observaciones
	Micromotor 31-ESS para MD20		Con cable: 3m
	Ref.: 48-2064	1.398 <sup>00</sup> €	BAJO PEDIDO
	Micromotor 31-ESS para MD10		Con cable: 2m
	Ref.: 48-2063	1.398 <sup>00</sup> €	BAJO PEDIDO
	Micromotor 21 para MD30 / MD11		Con cable: 2m *Hasta agotar existencias, después cambia PVP a 1.398,00€ y bajo pedido.
	Ref.: 48-2097	1.108 <sup>00</sup> €	
	Varilla soporte suero motores Nouvag® MD10, MD11, MD20, MD30		
	Ref.: 48-1770	32 <sup>80</sup> €	

## REPUESTOS TKD®





### Repuestos lámparas fotocurado



	Descripción		Observaciones
	Guía de luz / Fibra óptica TKD® Moon Ø8mm.		Campo Fotocurado: 8mm
	Ref.: 40-53001	118 <sup>00</sup> €	
	Manguera lámpara TKD® Moon		Open end Longitud: 160cm Color: Gris oscuro (RAL 7038) Regulación de spray Compatible lámpara Castellini T-LED
	Ref.: 40-91A2000	52 <sup>80</sup> €	

## Accesorios ultrasonidos y micromotores

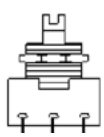

	Descripción	Observaciones
	Convertidor CONV24 de 24V AC/CA a 32V DC/CC  <b>Ref.: 40-39400</b>	24V AC/CA +/- 10%; 8A. <b>Dimensiones:</b> 60x50mm  <b>56<sup>80</sup>€</b>
	Potenciometro neumático PPOT  <b>Ref.: 40-39500</b>	<b>51<sup>80</sup>€</b>
	Potenciometro eléctrico  <b>Ref.: 40-03520</b>	<b>22<sup>80</sup>€</b>
	Selector MOT2 2 micromotores DEFINITIVE / DEFINITIVE LED  <b>Ref.: 40-39600</b>	<b>80<sup>80</sup>€</b>
	Panel de control DUOPAD  <b>Ref.: 40-39200</b>	13V DC/CC +/- 20%; 22mA <b>Dimensiones:</b> 73x117x24mm  Puede controlar 2 micromotores DEFINITIVE/LED y 1 ultrasonidos TITANUS.  <b>338<sup>00</sup>€</b>

## Repuestos ultrasonidos



	Descripción	Observaciones
	Placa electrónica TKD USC60 SCALERS TITANUS  <b>Ref.: 40-38700</b>	Dimensiones:  <b>248<sup>00</sup>€</b>

## Repuestos micromotores





















	Descripción	Observaciones
	Placa electrónica TKD BMC40 MM DEFINITIVE Todos los modelos  <b>Ref.: 40-39000</b>	<b>358<sup>00</sup>€</b>











# REPUESTOS WOODPECKER® Y DTE®











## Repuestos Ultrasonidos























	Descripción	Observaciones
	Placa electrónica Kit <b>UDS-N3</b> y <b>UDS-N3 LED</b>  <b>Ref.: 28-PCB005</b>	112 <sup>80</sup> €
	Placa electrónica Kit <b>DTE-V3</b> y <b>DTE-V3 LED</b>  <b>Ref.: 28-PCB001</b>	112 <sup>80</sup> €
	Válvula solenoide ultrasonidos Woodpecker® <b>UDS-P, UDS-E, U600*</b> y compatibles Válvula solenoide ultrasonidos DTE® <b>D3, D5, D600*</b> y compatibles Válvula solenoide micromotor Woodpecker® <b>M2 PRO</b>  <b>Ref.: 28-U013</b>	* Llevan dos modelos de solenoide, para la otra ver 28-U035  22 <sup>80</sup> €
	Válvula solenoide ultrasonidos Woodpecker® <b>U600*</b> y compatibles Válvula solenoide ultrasonidos DTE® <b>D600*</b> y compatibles  <b>Ref.: 28-U035</b>	* Llevan dos modelos de solenoide, para la otra ver 28-U013  22 <sup>80</sup> €
	Válvula solenoide ultrasonidos DTE® <b>D7</b> y compatibles  <b>Ref.: 28-U025</b>	22 <sup>80</sup> €
	Válvula solenoide ultrasonidos Woodpecker® <b>U6</b> y DTE® <b>S6</b>  <b>Ref.: 28-U043</b>	22 <sup>80</sup> €
	Fusible ultrasonidos Woodpecker® <b>UDS-P, UDS-E; DTE® D3, D5, D7</b> y compatibles  <b>Ref.: 28-U014</b>	Voltaje: 250V Tensión: 5K Amperaje: 0,5A  12 <sup>80</sup> €
	Tubo gris ultrasonidos Woodpecker® <b>UDS-P, UDS-E, U600; DTE® D5, D7, D600</b> y compatibles  <b>Ref.: 28-U015</b>	Largo: 250cm  12 <sup>80</sup> €
	Transformador ultrasonidos Woodpecker® <b>UDS-P, UDS-E y U6; DTE® D5, D7, S6</b> y compatibles  <b>Ref.: 28-TRA005</b>	38 <sup>00</sup> €









	Descripción	Observaciones
	<p>Pedal ultrasonidos Woodpecker® <b>UDS-P, UDS-E y U6</b>; DTE® <b>D5, D7, S6 y D600</b> y compatibles</p> <p>Ref.: <b>28-U016</b> <span style="float: right;"><b>30´80€</b></span></p>	
	<p>Botella con tapa 500ml DTE® <b>D7</b> y Woodpecker® <b>UDS-E</b></p> <p>Ref.: <b>28-U017</b> <span style="float: right;"><b>13´80€</b></span></p>	
	<p>Conector espigas entrada ultrasonidos DTE® <b>D7</b></p> <p>Ref.: <b>28-U018</b> <span style="float: right;"><b>11´80€</b></span></p>	
	<p>Conectores receptor hembra botella ultrasonidos Woodpecker® <b>UDS-E</b> y DTE® <b>D7</b></p> <p>Ref.: <b>28-U019</b> <span style="float: right;"><b>10´80€</b></span></p>	
	<p>Potenciometro regulación caudal ultrasonidos Woodpecker® <b>UDS-E</b> y DTE® <b>D7</b> y compatibles</p> <p>Ref.: <b>28-U020</b> <span style="float: right;"><b>10´80€</b></span></p>	
	<p>Regulador caudal ultrasonidos Woodpecker® <b>UDS-P</b> y DTE® <b>D5</b> y compatibles</p> <p>Ref.: <b>28-U030</b> <span style="float: right;"><b>13´80€</b></span></p>	
	<p>Soporte pieza de mano ultrasonidos Woodpecker® <b>UDS-E</b> y DTE® <b>D7, D5, D3</b> y compatibles</p> <p>Ref.: <b>28-U022</b> <span style="float: right;"><b>12´80€</b></span></p>	
	<p>Conexión entrada agua ultrasonidos Woodpecker® <b>UDS-P</b> y DTE® <b>D5</b> y compatibles</p> <p>Ref.: <b>28-U023</b> <span style="float: right;"><b>2´80€</b></span></p>	
	<p>Anillo tórico conexión botella suministro agua ultrasonidos Woodpecker® <b>UDS-E</b> y DTE® <b>D7</b></p> <p>Ref.: <b>28-U027</b> <span style="float: right;"><b>0´90€</b></span></p>	
	<p>Placa electrónica central ultrasonidos DTE <b>D7, D7 LED, D5 y D5 LED</b></p> <p>Ref.: <b>28-PCB002</b> <span style="float: right;"><b>118´00€</b></span></p>	



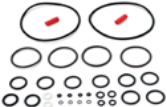





	Descripción	Observaciones
	<p>Panel botonera ultrasonidos DTE <b>D7</b></p> <p>Ref.: <b>28-U028</b> <span style="float: right;"><b>50<sup>80</sup>€</b></span></p>	
	<p>Manguera ultrasonidos <b>UDS-E, UDS-P, UDS-A, UDS-K y UDS-N3</b></p> <p>Ref.: <b>28-U007</b> <span style="float: right;"><b>39<sup>80</sup>€</b></span></p>	<p>Longitud: 200cm                      Color: Gris claro (RAL 9002)                      Color del terminal: Crema                      Diámetro: 7mm (FINA)</p>
	<p>Manguera ultrasonidos <b>U600 LED, U6 LED, UDS-E LED, UDS-P LED, UDS-A LED, UDS-K LED y UDS-N3 LED</b></p> <p>Ref.: <b>28-U010</b> <span style="float: right;"><b>50<sup>80</sup>€</b></span></p>	<p>Longitud: 200cm                      Color: Gris claro (RAL 9002)                      Color del terminal: Crema                      Diámetro: 7mm (FINA)</p>
	<p>Manguera ultrasonidos <b>D3, D5, D7, D600 y V3</b></p> <p>Ref.: <b>28-U008</b> <span style="float: right;"><b>39<sup>80</sup>€</b></span></p>	<p>Longitud: 200cm                      Color: Gris claro (RAL 9002)                      Color del terminal: Crema                      Diámetro: 7mm (FINA)</p>
	<p>Manguera ultrasonidos <b>D3 LED, D5 LED, D7 LED y V3 LED</b></p> <p>Ref.: <b>28-U009</b> <span style="float: right;"><b>50<sup>80</sup>€</b></span></p>	<p>Longitud: 200cm                      Color: Gris claro (RAL 9002)                      Color del terminal: Crema                      Diámetro: 7mm (FINA)</p>
	<p>Manguera ultrasonidos <b>U600 y U6</b></p> <p>Ref.: <b>28-U046</b> <span style="float: right;"><b>50<sup>80</sup>€</b></span></p>	<p>Longitud: 200cm                      Color: Gris claro (RAL 9002)                      Color del terminal: Dorado                      Diámetro: 7mm</p>
	<p>Manguera ultrasonidos DTE <b>D600 LED y S6 LED</b></p> <p>Ref.: <b>28-U044</b> <span style="float: right;"><b>50<sup>80</sup>€</b></span></p>	<p>Longitud: 200cm                      Color: Gris claro (RAL 9002)                      Color del terminal: Plateado                      Diámetro: 7mm</p>
	<p>Potenciómetro regulación caudal ultrasonidos para <b>suministro interno</b> Woodpecker® <b>U600 y DTE® D600</b></p> <p>Ref.: <b>28-U021</b> <span style="float: right;"><b>13<sup>80</sup>€</b></span></p>	
	<p>Regulador caudal ultrasonidos para <b>suministro externo</b> Woodpecker® <b>U6 y U600, DTE® S6 y D600</b></p> <p>Ref.: <b>28-U031</b> <span style="float: right;"><b>13<sup>80</sup>€</b></span></p>	
	<p>Tanque con tapa ultrasonidos Woodpecker® <b>U600 y DTE® D600</b></p> <p>Ref.: <b>28-U032</b> <span style="float: right;"><b>18<sup>80</sup>€</b></span></p>	

	Descripción	Observaciones
	Bomba de agua ultrasonidos Woodpecker® <b>U600, UDS-E, AP-B, PT-A</b> y DTE® <b>D600</b> y <b>D7</b>  <b>Ref.: 28-U026</b>	42´80€
	Cable alimentación ultrasonidos Woodpecker® <b>U600</b> y DTE® <b>D600</b>  <b>Ref.: 28-TRA014</b>	16´80€
	Manguera aeropulidor <b>AP-B, AP-A</b> y <b>PT-A</b>  <b>Ref.: 28-U033</b>	Terminal dorado  128´00€
	Manguera ultrasonidos <b>AP-B</b>  <b>Ref.: 28-U034</b>	48´00€
	Pedal <b>AP-A, AP-B</b> y <b>COMP</b>  <b>Ref.: 28-U016</b>	30´80€
	Soporte pieza de mano aeropulidor <b>AP-B</b> (Naranja)  <b>Ref.: 28-U064</b>	13´80€
	Soporte pieza de mano ultrasonidos <b>AP-B</b> (Naranja)  <b>Ref.: 28-U065</b>	13´80€
	Válvula solenoide unidad de profilaxis <b>AP-B, PT-A*</b> y compatibles  <b>Ref.: 28-U035</b>	* Llevan dos modelos de solenoide, para la otra ver 28-U013  22´80€
	Bloque válvulas solenoide aeropulidor <b>AP-B</b> y <b>AP-A</b>  <b>Ref.: 28-U036</b>	64´80€
	Placa electrónica central <b>AP-B</b>  <b>Ref.: 28-PCB004</b>	548´00€











	Descripción	Observaciones
	<p>Fuente alimentación <b>AP-B</b> y <b>AP-A</b></p> <p>Ref.: <b>28-TRA015</b></p> <p><b>54<sup>80</sup>€</b></p>	
	<p>Depósito con tapa dorada para polvos de tratamiento <b>subgingival AP-B</b> (Naranja)*</p> <p>Ref.: <b>28-U038</b></p> <p><b>78<sup>00</sup>€</b></p>	<p>*Dispositivos con N/S &lt; AP23A0071PB <b>Anillos tóricos conexión Ref: 28-U045</b></p>
	<p>Depósito con tapa dorada para polvos de tratamiento <b>supragingival AP-B</b> (Naranja)*</p> <p>Ref.: <b>28-U039</b></p> <p><b>78<sup>00</sup>€</b></p>	<p>*Dispositivos con N/S &lt; AP23A0071PB <b>Anillos tóricos conexión Ref: 28-U045</b></p>
 <p>Imagen no disponible</p>	<p>Kit 2 anillos tóricos conexión depósitos polvo <b>AP-B, AP-A, PT-A y PT-B</b></p> <p>Ref.: <b>28-U045</b></p> <p><b>2<sup>80</sup>€</b></p>	
	<p>Anillo tórico conexiones botellas agua <b>AP-B, AP-A, PT-A y PT-B</b></p> <p>Ref.: <b>28-U071</b></p> <p><b>0<sup>80</sup>€</b></p>	<p><b>Nota:</b> La conexión requiere de 2 anillos tóricos</p>
	<p>Kit 2 tubos paso/corte polvos <b>PT-A, AP-B y AP-A</b></p> <p>Ref.: <b>28-U072</b></p> <p><b>2<sup>80</sup>€</b></p>	
	<p>Botella 700ml <b>AP-B</b> (Naranja) con tapa dorada</p> <p>Ref.: <b>28-U040</b></p> <p><b>38<sup>00</sup>€</b></p>	
	<p>Botella 700ml <b>AP-B</b> y <b>AP-A</b> (Blanco) con tapa plateada</p> <p>Ref.: <b>28-U068</b></p> <p><b>38<sup>00</sup>€</b></p>	
	<p>Conector rápido compatible entrada aire comprimido <b>AP-B, AP-A y PT-A</b></p> <p>Ref.: <b>28-U041</b></p> <p><b>28<sup>00</sup>€</b></p>	
	<p>Filtro aire <b>AP-B</b> y <b>AP-A</b></p> <p>Ref.: <b>28-U042</b></p> <p><b>20<sup>80</sup>€</b></p>	







	Descripción	Observaciones
	Depósito con tapa plateada para polvo tratamiento Supragingival <b>PT-A*</b> , <b>AP-A*</b> y <b>AP-B*</b> (Blanco)  <b>Ref.: 28-PB0013</b> <span style="float: right;"><b>78<sup>00</sup>€</b></span>	*Dispositivos con N/S > AP23A0540A
	Depósito con tapa plateada para polvo tratamiento Subgingival <b>PT-A*</b> , <b>AP-A*</b> y <b>AP-B*</b> (Blanco)  <b>Ref.: 28-PB0014</b> <span style="float: right;"><b>78<sup>00</sup>€</b></span>	*Dispositivos con N/S > AP23A0540A
	Depósito 600 ml <b>PT-A</b> y <b>PT-B</b>  <b>Ref.: 28-U057</b> <span style="float: right;"><b>22<sup>80</sup>€</b></span>	
	Depósito 1400 ml <b>AP-B</b> , <b>PT-A</b> y <b>PT-B</b>  <b>Ref.: 28-U058</b> <span style="float: right;"><b>44<sup>80</sup>€</b></span>	
	Soporte pieza de mano ultrasonidos <b>YZ-2L / PT-A</b> y pieza de mano ultrasonidos <b>AP-B</b> (Blanco)  <b>Ref.: 28-U050</b> <span style="float: right;"><b>13<sup>80</sup>€</b></span>	
	Soporte pieza de mano aeropulidor <b>PT-A</b> , <b>AP-B</b> (Blanco) y <b>AP-A</b>  <b>Ref.: 28-U059</b> <span style="float: right;"><b>13<sup>80</sup>€</b></span>	
	Manguera ultrasonidos <b>YZ-2L</b> , <b>PT-A</b>  <b>Ref.: 28-U051</b> <span style="float: right;"><b>188<sup>00</sup>€</b></span>	
	Válvula solenoide unidades de profilaxis Woodpecker® <b>PTA*</b> y compatibles  <b>Ref.: 28-U013</b> <span style="float: right;"><b>22<sup>80</sup>€</b></span>	*Llevar dos modelos de solenoide, para la otra ver 28-U035
	Toma aire <b>PT-A</b>  <b>Ref.: 28-U073</b> <span style="float: right;"><b>9<sup>80</sup>€</b></span>	
	Bloque válvulas solenoide <b>PT-A</b> y <b>PT-B</b>  <b>Ref.: 28-U060</b> <span style="float: right;"><b>54<sup>80</sup>€</b></span>	*Confirmar antes PT-A tiene tres solenoides distintas

	Descripción	Observaciones
	<p>Válvula regulación polvos <b>PT-A</b> y <b>PT-B</b></p> <p>Ref.: <b>28-U074</b></p> <p><b>42<sup>80</sup>€</b></p>	
	<p>Regulador caudal para <b>suministro externo</b> <b>PT-A</b></p> <p>Ref.: <b>28-U031</b></p> <p><b>13<sup>80</sup>€</b></p>	
	<p>Sistema calentador <b>PT-A</b></p> <p>Ref.: <b>28-U053</b></p> <p><b>138<sup>00</sup>€</b></p>	
	<p>Kit completo 32 anillos tóricos <b>PT-A</b> y <b>AP-B</b></p> <p>Ref.: <b>28-U056</b></p> <p><b>22<sup>80</sup>€</b></p>	
	<p>Pedal multifunción <b>PT-A</b></p> <p>Ref.: <b>28-U061</b></p> <p><b>22<sup>80</sup>€</b></p>	
	<p>Transformador <b>PT-A</b></p> <p>Ref.: <b>28-TRA016</b></p> <p><b>42<sup>80</sup>€</b></p>	
	<p>Filtro de aire <b>PT-A</b></p> <p>Ref.: <b>28-U062</b></p> <p><b>28<sup>00</sup>€</b></p>	
	<p>Toma de agua <b>PT-A</b></p> <p>Ref.: <b>28-U063</b></p> <p><b>6<sup>80</sup>€</b></p>	
	<p>Potenciómetro kits built in <b>V3, V3 LED, UDS-N3, UDS-N3 LED</b></p> <p>Ref.: <b>28-U001</b></p> <p><b>15<sup>80</sup>€</b></p>	
	<p>LED pieza de mano <b>YZ-2L</b></p> <p>Ref.: <b>28-U037</b></p> <p><b>6<sup>80</sup>€</b></p>	



	Descripción	Observaciones
	<p>LED pieza de mano <b>HW-5L</b></p> <p>Ref.: <b>28-U004</b></p>	<p>6'80€</p>
	<p>Soporte LED pieza de mano <b>HW-5L</b></p> <p>Ref.: <b>28-U003</b></p>	<p>3'80€</p>
	<p>Punta pieza de mano <b>HW-5L</b></p> <p>Ref.: <b>28-U049</b></p>	<p>6'80€</p>
	<p>LED pieza de mano <b>HD-7L</b> y <b>HD-8L</b></p> <p>Ref.: <b>28-U002</b></p>	<p>6'80€</p>
	<p>Soporte LED pieza de mano <b>HD-7L</b></p> <p>Ref.: <b>28-U005</b></p>	<p>3'80€</p>
	<p>Soporte LED pieza de mano <b>HD-8L</b></p> <p>Ref.: <b>28-U006</b></p>	<p>3'80€</p>
	<p>Transformador <b>AT-1</b></p> <p>Ref.: <b>28-TRA002</b></p>	<p>16'80€</p>
	<p>Tubos grises paralelos <b>AT-1</b></p> <p>Ref.: <b>28-U024</b></p>	<p>8'00€</p>

## Repuestos Aeropulidores

	Descripción	Observaciones
	Cabeza pieza de mano <b>AP-1</b>  <b>Ref.: 28-PB0001</b> <span style="float: right;"><b>138<sup>00</sup>€</b></span>	Válido para modelo actual de AP-1.  Consultar
	Cabeza pieza de mano <b>AP-2</b>  <b>Ref.: 28-PB0002</b> <span style="float: right;"><b>138<sup>00</sup>€</b></span>	
 <small>Imagen no disponible</small>	Kit 2 anillos tóricos conexión manguera piezas de mano <b>AP-1</b> y <b>AP-2</b>  <b>Ref.: 28-PB0003</b> <span style="float: right;"><b>2<sup>80</sup>€</b></span>	Válido para modelo actual de AP-1.  Consultar
	Kit 2 anillos tóricos cabeza pieza de mano <b>AP-1</b> y <b>AP-1 PLUS</b>  <b>Ref.: 28-PB0004</b> <span style="float: right;"><b>2<sup>80</sup>€</b></span>	Válido para modelo actual de AP-1.  Consultar
 <small>Imagen no disponible</small>	Kit 2 anillos tóricos cabeza pieza de mano <b>AP-2</b> y <b>AP-2 PLUS</b>  <b>Ref.: 28-PB0005</b> <span style="float: right;"><b>2<sup>80</sup>€</b></span>	
	Aguja limpieza GRANDE <b>AP-1, AP-1 PLUS, AP-2</b> y <b>AP-2 PLUS</b>  <b>Ref.: 28-WA017</b> <span style="float: right;"><b>2<sup>80</sup>€</b></span>	
	Aguja limpieza PEQUEÑA <b>AP-1, AP-1 PLUS, AP-2</b> y <b>AP-2 PLUS</b>  <b>Ref.: 28-WA018</b> <span style="float: right;"><b>2<sup>80</sup>€</b></span>	
	Conexión <b>Midwest 4 AP-H</b> y <b>AP-H PLUS</b>  <b>Ref.: 28-PB0006</b> <span style="float: right;"><b>83<sup>80</sup>€</b></span>	
	Conexión tipo <b>KaVo® AP-H</b> y <b>AP-H PLUS</b>  <b>Ref.: 28-PB0007</b> <span style="float: right;"><b>83<sup>80</sup>€</b></span>	
	Conexión tipo <b>NSK® AP-H</b> y <b>AP-H PLUS</b>  <b>Ref.: 28-PB0008</b> <span style="float: right;"><b>83<sup>80</sup>€</b></span>	

	Descripción	Observaciones
	Conexión tipo <b>Sirona® AP-H y AP-H PLUS</b>  <b>Ref.: 28-PB0009</b>	83'80.€
	Kit 2 anillos tóricos conexión <b>AP-H / AP-H PLUS</b> con piezas de mano <b>AP-1 PLUS y AP-2 PLUS</b>  <b>Ref.: 28-PB0010</b>	2'80.€
	Tapa contenedor <b>AP-H y AP-H PLUS</b>  <b>Ref.: 28-PB0011</b>	14'80.€
	Junta para contenedor <b>AP-H y AP-H PLUS</b>  <b>Ref.: 28-PB0012</b>	1'80.€
	Kit completo 18 anillos tóricos <b>AP-H y AP-H PLUS*</b>  <b>Ref.: 28-PB0023</b>	*Conexión <b>NSK®</b> : No incluye anillos tóricos conexión manguera. Ver Ref <b>28-PB0024</b>  22'80.€
	Kit 4 anillos tóricos conexión <b>NSK®</b> aeropulidores <b>AP-H y AP-H PLUS</b>  <b>Ref.: 28-PB0024</b>	2'80.€











Repuestos Motores Endodoncia y EndoActivadores 

	Descripción	Observaciones
	Pieza de mano endo activador ultrasónico <b>Woodpecker® Endo 1</b> (Blanco)  <b>Ref.: 28-PM006</b>	Roscas tipo: EMS  108'00.€
	Pieza de mano endo activador ultrasónico <b>DTE® Endo 1</b> (Violeta)  <b>Ref.: 28-PM007</b>	Roscas tipo: S  108'00.€
 <p data-bbox="119 1998 210 2016">Imagen no disponible</p>	Pieza de mano motor endo <b>Ai-Motor Terauchi® Black Edition</b>  <b>Ref.: 28-PM013</b>	Color: Negro  Sin contra ángulo  748'00.€























	Descripción	Observaciones
	Base <b>Motopex</b>  <b>Ref.: 28-BAS008</b>	78 <sup>00</sup> €
	Base <b>Endo Smart +</b>  <b>Ref.: 28-BAS017</b>	78 <sup>00</sup> €
	Base <b>Smart-A</b>  <b>Ref.: 28-BAS009</b>	<b>Color:</b> Blanca  228 <sup>00</sup> €
	Base <b>Smart-A</b>  <b>Ref.: 28-BAS010</b>	<b>Color:</b> Naranja  228 <sup>00</sup> €
	Base <b>Ai-Motor Terauchi® Black Edition</b>  <b>Ref.: 28-BAS018</b>	108 <sup>00</sup> €
	Base Endo activador <b>Endo1</b>  <b>Ref.: 28-BAS002</b>	<b>Color:</b> Blanco  28 <sup>00</sup> €
	Base Endo activador <b>Endo1</b>  <b>Ref.: 28-BAS003</b>	<b>Color:</b> Violeta  28 <sup>00</sup> €
	Base Endo activador <b>Endo3</b>  <b>Ref.: 28-BAS013</b>	98 <sup>00</sup> €
	Pedal <b>Smart-A</b>  <b>Ref.: 28-ME009</b>	<b>Color:</b> Naranja  208 <sup>00</sup> €
	Pedal <b>Smart-A</b>  <b>Ref.: 28-ME008</b>	<b>Color:</b> Blanca  208 <sup>00</sup> €

	Descripción	Observaciones
	<p>Soporte LED <b>E-com+</b></p> <p>Ref.: <b>28-U029</b></p>	<p>8<sup>00</sup>€</p>

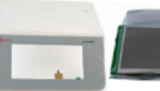
Repuestos Piezo eléctricos cirugía



	Descripción	Observaciones
	<p>Bomba Woodpecker® <b>Surgic Touch LED, Surgic X LED</b> y sus versiones sin luz</p> <p>Ref.: <b>28-MI003</b></p>	<p>139<sup>80</sup>€</p>
	<p>Cable suministro eléctrico Woodpecker® <b>Surgic Touch LED, Surgic X LED</b> y sus versiones sin luz</p> <p>Ref.: <b>28-TRA014</b></p>	<p>16<sup>80</sup>€</p>
	<p>Pedal multifuncional con cable Woodpecker® <b>Surgic Touch LED, Surgic X LED</b> y sus versiones sin luz</p> <p>Ref.: <b>28-U069</b></p>	<p>Longitud cable: 280cm</p> <p>84<sup>80</sup>€</p>
	<p>Soporte suero Woodpecker® <b>Surgic Touch LED, Surgic X LED</b> y sus versiones sin luz</p> <p>Ref.: <b>28-MI009</b></p>	<p>10<sup>80</sup>€</p>
	<p>LED pieza de mano <b>HB-1L</b></p> <p>Ref.: <b>28-U047</b></p>	<p>9<sup>80</sup>€</p>
	<p>Soporte LED pieza de mano <b>HB-1L</b></p> <p>Ref.: <b>28-U048</b></p>	<p>11<sup>80</sup>€</p>











	Descripción	Observaciones
	Cable micromotor LED SPM-58L Woodpecker® <b>Implanter LED</b> y <b>DTE® Implant X LED</b>  <b>Ref.: 28-MI001</b>	<b>Longitud:</b> 180cm <b>Conector:</b> Gris 6 pines y 2 muescas  <b>118<sup>00</sup>€</b>
	Cable micromotor LED SPM-58L Woodpecker® <b>Implanter LED PLUS</b> y <b>DTE® Implant X LED Plus</b>  <b>Ref.: 28-MI006</b>	<b>Longitud:</b> 180cm <b>Conector:</b> Azul 10 pines y 2 muescas  <b>118<sup>00</sup>€</b>
	Cable micromotor LED SPM-58L Woodpecker® <b>Implanter LED</b> y <b>DTE® Implant X LED</b> (Modelos antiguos)  <b>Ref.: 28-MI008</b>	<b>Longitud:</b> 180cm <b>Conector:</b> Negro 6 pines y 1 muesca  <b>118<sup>00</sup>€</b>
	Placa electrónica Woodpecker® <b>Implanter LED</b> y <b>DTE® Implant X LED</b>  <b>Ref.: 28-PCB003</b>	<b>280<sup>00</sup>€</b>
	Display Woodpecker® <b>Implanter LED</b> y <b>DTE® Implant X LED</b>  <b>Ref.: 28-MI002</b>	<b>218<sup>80</sup>€</b>
	Bomba Woodpecker® <b>Implanter LED, Implanter LED Plus, DTE® Implant X LED, Implant X LED Plus</b> y sus versiones sin luz  <b>Ref.: 28-MI003</b>	<b>139<sup>80</sup>€</b>
	Cable suministro eléctrico Woodpecker® <b>Implanter LED, Implanter LED Plus, DTE® Implant X LED, Implant X LED Plus</b> y sus versiones sin luz  <b>Ref.: 28-TRA014</b>	<b>16<sup>80</sup>€</b>
	Pedal multifuncional con cable Woodpecker® <b>Implanter LED, Implanter LED Plus, DTE® Implant X LED, Implant X LED Plus</b> y sus versiones sin luz  <b>Ref.: 28-MI005</b>	<b>Longitud cable:</b> 280cm  <b>84<sup>80</sup>€</b>
	Soporte goma Woodpecker® piezas de mano y micromotor  <b>Ref.: 28-U048</b>	<b>11<sup>80</sup>€</b>
	Soporte suero Woodpecker® <b>Implanter LED, Implanter LED Plus, DTE® Implant X LED, DTE® Implant X LED Plus</b> y sus versiones sin luz  <b>Ref.: 28-MI009</b>	<b>10<sup>80</sup>€</b>



Para repuestos contra ángulos Woodpecker® consultar sección repuestos rotatorio.

SI NO ENCUENTRAS EL REPUESTO QUE BUSCAS, ¡CONSÚLTANOS!  
 Precios: impuestos, portes y mano de obra no incluidos.

## Repuestos Localizador de Ápices









	Descripción	Observaciones
	<p>Gancho labial localizadores de ápices y motores Endo con localizador de ápices Woodpecker® y DTE®:</p> <p><b>Woodpex V</b> <b>Ai-PEX</b> <b>Minipex</b></p> <p><b>Endo Radar</b> <b>Endo Radar "Plus"</b> <b>Motopex</b></p> <p><b>Ai-Motor</b> <b>Smart A</b></p> <p>Ref.: <b>28-WA012</b></p> <p><b>10'80€</b></p>	<p>Pack: 2 Unidades</p> <p>Compatible con Morita Triauto</p>
	<p>Punta test pulpa <b>Ai-Pex</b>.</p> <ul style="list-style-type: none"> <li>- Fino para piezas dentales con coronas metálicas.</li> <li>- Grueso para todas las piezas dentales.</li> </ul> <p>Ref.: <b>28-WA014</b></p> <p><b>12'80€</b></p>	<p>Pack: 2 Unidades</p>
	<p>Cable medición localizadores de ápices:</p> <p><b>Woodpex I</b> <b>Woodpex III</b> <b>Woodpex V</b></p> <p><b>DPEX I</b> <b>DEPX III</b></p> <p>Ref.: <b>28-CAB001</b></p> <p><b>18'80€</b></p>	
	<p>Cable medición <b>Minipex</b>. (Antigua / conexión micro USB)</p> <p>Ref.: <b>28-CAB003</b></p> <p><b>15'80€</b></p>	<p>Conector micro USB</p>
	<p>Cable medición <b>Ai-Pex</b>.</p> <p>Cable medición <b>Minipex</b>. (Nueva / conexión USB tipo C)</p> <p>Ref.: <b>28-CAB007</b></p> <p><b>18'80€</b></p>	<p>Conector USB tipo C</p>
	<p>Cable gancho limas.</p> <p><b>Woodpex I</b> <b>Woodpex III</b> <b>Woodpex V</b></p> <p><b>DPEX I</b> <b>DEPX III</b> <b>DPEX III</b></p> <p><b>Ai-Pex</b> <b>Minipex</b></p> <p>Ref.: <b>28-CAB002</b></p> <p><b>19'80€</b></p>	
	<p>Transformador <b>Woodpex III, Woodpex V y DPEX III</b>.</p> <p>Ref.: <b>28-TRA002</b></p> <p><b>16'80€</b></p>	
	<p>Transformador <b>Minipex</b>. (Antigua / conexión micro USB)</p> <p>Ref.: <b>28-TRA004</b></p> <p><b>16'80€</b></p>	<p>Conector micro USB</p>
	<p>Transformador localizadores de ápices:</p> <p><b>Ai-Pex</b> <b>Minipex</b> (Nueva / conexión USB tipo C)</p> <p>Ref.: <b>28-TRA010</b></p> <p><b>28'00€</b></p>	<p>Conector USB tipo C</p>
	<p>Batería <b>Woodpex III, Woodpex V y DPEX III</b>.</p> <p>Ref.: <b>28-BAT004</b></p> <p><b>19'80€</b></p>	







	Descripción	Observaciones
	Batería <b>Ai-Pex</b> .  Ref.: <b>28-BAT007</b>	<b>28'80€</b>
	Batería localizador de ápices Woodpecker <b>Minipex</b> .  Ref.: <b>28-BAT012</b>	<b>19'80€</b>







## Repuestos Sistema de Inyección y obturación de Gutapercha







	Descripción	Observaciones
	Batería <b>Fi-G</b> .  Ref.: <b>28-BAT005</b>	<b>58'00€</b>
	Batería <b>Fi-P y Fi-E*</b> .  Ref.: <b>28-BAT006</b>	<b>58'00€</b> <small>*Si funda es requerida ver Ref. 28-SO008</small>
 <small>Imagen no disponible</small>	Funda batería <b>Fi-E</b> .  Ref.: <b>28-SO008</b>	<b>3'80€</b>
	Transformador <b>Fi-G, Fi-P y Fi-E</b> .  Ref.: <b>28-TRA012</b>	<b>58'00€</b>
	Martillo accionador <b>Fi-G</b> .  Ref.: <b>28-SO001</b>	<b>66'80€</b>
	Cierre y junta martillo accionador <b>Fi-G</b> .  Ref.: <b>28-SO003</b>	<b>3'80€</b> <small>Para Ref.: 28-SO001</small>
	Gatillo Woodpecker® <b>Fi-G</b> .  Ref.: <b>28-SO002</b>	<b>8'00€</b>

NUEVO

	Descripción	Observaciones
	<p>Base de carga <b>Fi-G</b>.</p> <p>Ref.: <b>28-BAS006</b></p> <p><b>58<sup>00</sup>€</b></p>	
	<p>Anillo limpiador <b>Fi-E*</b></p> <p>Ref.: <b>28-SO006</b></p> <p><b>5<sup>80</sup>€</b></p>	* Modelos hasta enero 2025
	<p>Cilindro interno <b>Fi-E*</b></p> <p>Ref.: <b>28-SO007</b></p> <p><b>3<sup>80</sup>€</b></p>	* Modelos hasta enero 2025
	<p>Base de carga <b>Fi-E</b>.</p> <p>Ref.: <b>28-BAS014</b></p> <p><b>48<sup>00</sup>€</b></p>	
	<p>Base de carga <b>Fi-P</b> blanco</p> <p>Ref.: <b>28-BAS007</b></p> <p><b>58<sup>00</sup>€</b></p>	
 No incluye batería	<p>Pieza de mano <b>Fi-E</b> Blanco</p> <p>Ref.: <b>28-PM008</b></p> <p><b>448<sup>00</sup>€</b></p>	* <b>No incluye batería</b> , para batería ver referencias 28-BAT006 y 28-SO008.
	<p>Pieza de mano <b>Fi-P</b> Blanco</p> <p>Ref.: <b>28-PM009</b></p> <p><b>248<sup>00</sup>€</b></p>	

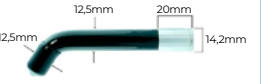
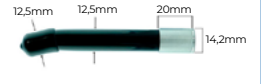
	Descripción	Observaciones
	<p>Transformador <b>i-Scan</b>.</p> <p>Ref.: <b>28-TRA011</b></p> <p><b>49<sup>80</sup>€</b></p>	
	<p>Funda silicona <b>i-Sensor H1</b>.</p> <p>Ref.: <b>28-WA009</b></p> <p><b>3<sup>80</sup>€</b></p>	
	<p>Funda silicona <b>i-Sensor H2</b>.</p> <p>Ref.: <b>28-WA010</b></p> <p><b>3<sup>80</sup>€</b></p>	
	<p>Soporte goma <b>i-Sensor H1 y H2</b>.</p> <p>Ref.: <b>28-WA015</b></p> <p><b>6<sup>80</sup>€</b></p>	
<b>NUEVO</b>  <small>Imagen no disponible</small>	<p>Cable conexión escáner intraoral DM-RUMAR <b>Swift Scan</b>.</p> <p>Ref.: <b>28-CAB008</b></p> <p><b>28<sup>00</sup>€</b></p>	
<b>NUEVO</b>  <small>Imagen no disponible</small>	<p>Punta S escáner intraoral DM-RUMAR <b>Swift Scan</b>.</p> <p>Ref.: <b>28-IM001</b></p> <p><b>99<sup>80</sup>€</b></p>	
<b>NUEVO</b>  <small>Imagen no disponible</small>	<p>Punta L escáner intraoral DM-RUMAR <b>Swift Scan</b>.</p> <p>Ref.: <b>28-IM002</b></p> <p><b>99<sup>80</sup>€</b></p>	

	Descripción	Observaciones
	<p>Guía de luz / Fibra óptica <b>Woodpecker® LED.G, LED.C, LED.D, LED.F, LED.P, LED.B y LUX E PLUS.</b></p> <p><b>Ref.: 28-FO001</b></p> <p><b>18'80€</b></p>	<p>Campo Fotocurado: 8mm</p>
	<p>Guía de luz / Fibra óptica, <b>Woodpecker® LED.H LED.H ORTHO y BA OPTIMA 10.</b></p> <p><b>Ref.: 28-FO002</b></p> <p><b>18'80€</b></p>	<p>Campo Fotocurado: 8mm</p>
	<p>Guía de luz / Fibra óptica, Biselada <b>Woodpecker® LED.H, LED.H ORTHO y BA OPTIMA 10.</b></p> <p><b>Ref.: 28-FO003</b></p> <p><b>22'80€</b></p>	<p>Campo Fotocurado: 8mm</p>
	<p>Guía de luz / Fibra óptica 8mm diám. / conector: Ø10mm</p> <p><b>Ref.: 44-225</b></p> <p><b>18'80€</b></p>	<p>Campo Fotocurado: 8mm</p>
	<p>Punta DTE® <b>iLED MAX y iLED II</b></p> <p><b>Ref.: 28-FO008</b></p> <p><b>59'80€</b></p>	<p>Metálica Campo fotocurado: 10mm</p>
	<p>Lente transparente punta Woodpecker®/DTE® <b>iLED MAX, iLED II, O-Star y O-Star PRO</b></p> <p><b>Ref.: 28-LF006</b></p> <p><b>12'80€</b></p>	
	<p>Lente transparente punta metálica DTE® <b>iLED PLUS</b> (modelo nuevo) y B-Cure Plus, 1ud.</p> <p><b>Ref.: 28-LF005</b></p> <p><b>0'90€</b></p>	<p><b>HASTA AGOTAR</b></p>
	<p>Punta DTE® <b>B-Cure Plus metálica.</b></p> <p><b>Ref.: 28-FO010</b></p> <p><b>64'80€</b></p>	<p>Metálica Campo Fotocurado: 8mm</p> <p><b>HASTA AGOTAR</b></p>
	<p>Punta DTE® <b>VV Light</b></p> <p><b>Ref.: 28-FO011</b></p> <p><b>39'80€</b></p>	<p>Metálica Campo Fotocurado: 10mm</p>
	<p>Guía de luz / Fibra óptica Woodpecker® <b>LUX VI.</b></p> <p><b>Ref.: 28-FO004</b></p> <p><b>18'80€</b></p>	<p>Campo Fotocurado: 8mm</p>





	Descripción	Observaciones
	<p>Guía de luz / Fibras ópticas Woodpecker® <b>X-cure</b> standard.</p> <p><b>Ref.: 28-FO005</b></p> <p><b>44<sup>80</sup>€</b></p>	<p>Campo Fotocurado: 10mm</p>
	<p>Guía de luz / Fibras ópticas Woodpecker® <b>X-cure</b> biselada</p> <p><b>Ref.: 28-FO007</b></p> <p><b>44<sup>80</sup>€</b></p>	<p>Campo Fotocurado: 10mm</p>
	<p>Punta Woodpecker® <b>O-Star</b></p> <p><b>Ref.: 28-FO006</b></p> <p><b>108<sup>00</sup>€</b></p>	<p>Metálica Campo Fotocurado: 10mm</p>
	<p>Punta Woodpecker® <b>O-Star PRO</b></p> <p><b>Ref.: 28-FO012</b></p> <p><b>108<sup>00</sup>€</b></p>	<p>Metálica Campo Fotocurado: 10mm</p>
	<p>Lente de cura de puntos lámpara Woodpecker®/DTE® <b>O-Star, O-Star PRO, iLED MAX y iLED II</b></p> <p><b>Ref.: 28-LF007</b></p> <p><b>19<sup>80</sup>€</b></p>	
	<p>Lente completo lámpara Woodpecker®/DTE® <b>O-Star, O-Star PRO, iLED MAX y iLED II</b></p> <p><b>Ref.: 28-LF008</b></p> <p><b>19<sup>80</sup>€</b></p>	<p>Metálica Campo Fotocurado: 10mm</p>

## Baterías lámparas de fotocurado











	Descripción	Observaciones
	Batería <b>ECO LED1</b> , Woodpecker® <b>LED.H y LED.H ORTHO</b>  <b>Ref.: 28-BAT001</b>	19´80€
	Batería Woodpecker® <b>LUX VI</b>  <b>Ref.: 28-BAT004</b>	19´80€
	Batería lámpara DTE® <b>iLED</b> todos los modelos* y Woodpecker® <b>LED.D, X-Cure y LUX E PLUS.</b>  <b>Ref.: 28-BAT002</b>	* No vale para la iLED II  19´80€
	Batería lámpara DTE® <b>iLED II</b>  <b>Ref.: 28-BAT007</b>	Distinta a la de la iLED  28´80€
	Batería lámpara Woodpecker® <b>LEDC</b>  <b>Ref.: 28-BAT003</b>	19´80€
	Batería lámpara DTE® <b>B-Cure</b>  <b>Ref.: 28-BAT011</b>	34´80€
	Batería lámpara <b>O-Star</b> (Modelo con conexión)  <b>Ref.: 28-BAT013</b>	*Estación base con conexión 28-BAS012  58´00€
	Batería lámpara <b>O-Star</b> (Modelo contactless)* y <b>O-Star PRO</b>  <b>Ref.: 28-BAT014</b>	*Estación base contactless 28-BAS020  58´00€



## Protectores vista lámparas de fotocurado



Descripción	Observaciones
 <p>Protector para vista <b>LED.L, LED.D, LED.G, LED.H, LED.H ORTHO, LED.C, LED.B, B-Cure, LUX E Plus.</b></p> <p><b>Ref.: 28-LF001</b> <b>5<sup>^</sup>80.€</b></p>	
 <p>Protector para vista <b>LUX VI</b></p> <p><b>Ref.: 28-LF003</b> <b>5<sup>^</sup>80.€</b></p>	
 <p>Protector para vista <b>iLED "todos los modelos", iLED II</b></p> <p><b>Ref.: 28-LF002</b> <b>5<sup>^</sup>80.€</b></p>	
 <p>Protector para vista <b>O-Star</b></p> <p><b>Ref.: 28-LF009</b> <b>5<sup>^</sup>80.€</b></p>	<p>Gafas protectoras modo check Ver lista aparatología.</p>
 <p>Protector para vista <b>VV Light</b></p> <p><b>Ref.: 28-LF010</b> <b>5<sup>^</sup>80.€</b></p>	

## Bases lámparas fotocurado

	Descripción	Observaciones
	Base <b>ECO LED1</b> y <b>Woodpecker® LED.H</b>  <b>Ref.: 28-BAS001</b>	<b>Color:</b> Dorado  <b>28<sup>´</sup>00.€</b>
	Base lámpara <b>DTE® iLED "todos los modelos"</b>  <b>Ref.: 28-BAS002</b>	<b>Color:</b> Blanco  <b>28<sup>´</sup>00.€</b>
	Base lámpara <b>DTE® iLED "todos los modelos"</b>  <b>Ref.: 28-BAS003</b>	<b>Color:</b> Violeta  <b>28<sup>´</sup>00.€</b>
	Base lámpara <b>Woodpecker® iLED II</b>  <b>Ref.: 28-BAS021</b>	<b>28<sup>´</sup>00.€</b>
	Base lámpara <b>Woodpecker® LED.D</b>  <b>Ref.: 28-BAS004</b>	<b>18<sup>´</sup>80.€</b>
	Base lámpara <b>Woodpecker® LED.C</b>  <b>Ref.: 28-BAS005</b>	<b>18<sup>´</sup>80.€</b>
	Base lámpara <b>Woodpecker® X-Cure "Golden"</b>  <b>Ref.: 28-BAS016</b>	<b>83<sup>´</sup>80.€</b>
	Base lámpara <b>Woodpecker® X-Cure "Silver"</b>  <b>Ref.: 28-BAS015</b>	<b>83<sup>´</sup>80.€</b>
	Base lámpara <b>DTE® B-Cure</b>  <b>Ref.: 28-BAS011</b>	<b>28<sup>´</sup>00.€</b>
	Base lámpara <b>Woodpecker® O-Star (Modelo con conexión)*</b>  <b>Ref.: 28-BAS012</b>	*Revisar tipo de conexión de carga base-pieza de mano  <b>64<sup>´</sup>80.€</b>

	Descripción	Observaciones
	Base lámpara <b>Woodpecker® O-Star</b> (Modelo contactless)*  <b>Ref.: 28-BAS020</b>	*Revisar tipo de conexión de carga base-pieza de mano  <b>98´00€</b>
	Base lámpara <b>Woodpecker® O-Star PRO</b>  <b>Ref.: 28-BAS022</b>	<b>98´00€</b>
	Base lámpara <b>Woodpecker® LUX E PLUS</b>  <b>Ref.: 28-BAS019</b>	<b>18´80€</b>



▶ Transformadores lámparas fotocurado







	Descripción	Observaciones
	Transformador <b>Woodpecker® LED.H, DTE iLED, iLED II, LED.C, LED.D, B-Cure, O-Star, Lux E Plus, y comp.</b>  <b>Ref.: 28-TRA002</b>	<b>16´80€</b>
	Transformador lámpara <b>Woodpecker® LUX VI</b>  <b>Ref.: 28-TRA001</b>	<b>16´80€</b>
	Transformador lámpara <b>Woodpecker® X-Cure</b>  <b>Ref.: 28-TRA003</b>	<b>19´80€</b>

▶ Repuestos otros aparatos





	Descripción	Observaciones
	Cable alimentación micromotor <b>Woodpecker® MT3</b>  <b>Ref.: 28-TRA014</b>	<b>16´80€</b>
	Pedal micromotor <b>Woodpecker® MT3</b>  <b>Ref.: 28-U016</b>	<b>30´80€</b>

	Descripción	Observaciones
	<p>Tanque con tapa micromotor Woodpecker® <b>MT3</b></p> <p>Ref.: <b>28-U032</b></p> <p><b>18<sup>80</sup>€</b></p>	
	<p>Bomba de agua micromotor Woodpecker® <b>MT3</b></p> <p>Ref.: <b>28-U026</b></p> <p><b>42<sup>80</sup>€</b></p>	
	<p>Válvula solenoide micromotor Woodpecker® <b>MT3</b></p> <p>Ref.: <b>28-U035</b></p> <p><b>22<sup>80</sup>€</b></p>	
<p><b>NUEVO</b></p>  <p>Imagen no disponible</p>	<p>Bomba micro diafragma Woodpecker® <b>MT3</b></p> <p>Ref.: <b>28-MM003</b></p> <p><b>49<sup>80</sup>€</b></p>	

Otros repuestos

RUMAR

	Descripción	Observaciones
	<p>Fuente de alimentación para dotar de luz a sillones dentales sin luz. Regulador de retardo apagado luz por manguera.</p> <p>Ref.: <b>44-480</b></p> <p><b>109<sup>80</sup>€</b></p>	<p>Tensión alimentación: 10 – 24 V AC/DC.                  Tensión salida: 1,5 – 5 V DC (Ajustable).                  Retraso apagado: 1-9 seg (Ajustable).                  Consumo máximo: 1 W.                  Intensidad máxima: 1 A.                  Actuación neumática</p>
	<p>Soporte instrumento polivalente.</p> <p>Ref.: <b>44-650</b></p> <p><b>4<sup>80</sup>€</b></p>	

CR

## COMPRESORES Y REPUESTOS

- Compresores MGF®
- Repuestos compresores MGF®
- Repuestos compresores Dürr®



Repuestos





**NOVEDAD**

Compresor

# PRIME 1

MGF Compressors



**POTENCIA Y DURABILIDAD  
EN UN DISEÑO  
SILENCIOSO Y COMPACTO**



**CON CAJA  
INSONORIZADA**



Prime es el máximo exponente de la gama: apto para uso intensivo, sistema de biela articulada y cilindro con camisa de latón para un deslizamiento óptimo y menor desgaste de los segmentos del pistón.

**La solución perfecta para una clínica con un solo sillón dental.** Los compresores **Prime 1** poseen un sistema de filtrado integrado, descarga electrocontrolada, protección térmica y amperimétrica y el **innovador sistema de secado con cristales adsorbentes**.

El sistema de secado con cristales adsorbentes integra filtración y secado de aire por lo que ya no se requiere de prefiltración de aire. A su vez, simplifica y reduce el mantenimiento, lo que se traduce en menores costos.

El nuevo secador no requiere aire de regeneración (purga) durante la fase de encendido, lo que garantiza un mayor rendimiento del compresor.

Prime 1 es la **versión monocilíndrica**, disponible en configuración básica y con caja de insonorización (Incluye ruedas para facilitar su colocación y desplazamiento).

Genera mínimas vibraciones y con solo 65 dB/1m de nivel sonoro está entre **los más silenciosos del mercado**.

Referencia	Potencia	Voltaje	Caudal	Capacidad	Nivel de ruido	Peso	Dimensiones	Garantía	Precio
98-PROFI00024M	0,75 kW	230 V	85 lt/min	24 L	65 dB	39 Kg	500x470x600 mm	24 +12 meses (Tras registrar producto)	1.838 <sup>00</sup> €
98-PRMB100024M15 (con caja insonorizada)					50 dB	67 Kg	530x500x800 mm		2.638 <sup>00</sup> €

**BAJO PEDIDO**

**Si no encuentras la solución que buscas ¡CONSÚLTANOS!**

**SI NO ENCUENTRAS EL REPUESTO QUE BUSCAS, ¡CONSÚLTANOS!**  
Precios: impuestos, portes y mano de obra no incluidos.

**NOVEDAD**

Compresor

# GENESI

MGF Compressors



**POTENCIA Y DURABILIDAD  
EN UN DISEÑO  
SILENCIOSO Y COMPACTO**



**CON CUBIERTA  
INSONORIZADA**

**CON CAJA  
INSONORIZADA**



Genesi ofrece una selección sencilla y fiable de modelos de compresores, la opción perfecta para presupuestos ajustados.

El modelo Genesi dispone de un funcionamiento **silencioso** con bajas vibraciones, sin renunciar a la configuración de compresores de gama alta: sistema de filtración integrado, control eléctrico de la descarga de presión en la tubería de impulsión, protección térmica y **el innovador sistema de secado con cristales adsorbentes**.

El sistema de secado con cristales adsorbentes integra filtración y secado de aire por lo que ya no se requiere de prefiltración de aire. A su vez, simplifica y reduce el mantenimiento, lo que se traduce en menores costos.

El nuevo secador no requiere aire de regeneración (purga) durante la fase de encendido, lo que garantiza un mayor rendimiento del compresor.

Genesi es la **versión de 2 cilindros**, disponible en configuración básica, con cubierta insonorizada y con caja de insonorización (Incluye ruedas para facilitar su colocación y desplazamiento).

Referencia	Potencia	Voltaje	Caudal	Capacidad	Nivel de ruido	Peso	Dimensiones	Garantía	Precio
98-DGE150024M	1,1 kW	230 V	135 lt/min	24 L	65 dB	33 Kg	500x420x600 mm	24 +12 meses (Tras registrar producto)	1.698 <sup>00</sup> €
98-DSK150040M (con cubierta insonorizada)				40 L	55 dB	46 Kg	710x460x890 mm		2.358 <sup>00</sup> €
98-DMB150024M15 (con caja insonorizada)				24 L	50 dB	67 Kg	530x500x800 mm		2.358 <sup>00</sup> €

**BAJO PEDIDO**

**BAJO PEDIDO**

**Si no encuentras la solución que buscas ¡CONSÚLTANOS!**

**NOVEDAD**

Compresor

# PRIME 2

MGF Compressors



**POTENCIA Y DURABILIDAD  
EN UN DISEÑO  
SILENCIOSO Y COMPACTO**



CON CUBIERTA  
INSONORIZADA

CON CAJA  
INSONORIZADA



Prime es el máximo exponente de la gama: apto para uso intensivo, sistema de biela articulada y cilindro con camisa de latón para un deslizamiento óptimo y menor desgaste de los segmentos del pistón.

**El más vendido.**

**Prime 2** es la **versión de 2 cilindros**, disponible en configuración básica, con cubierta insonorizada y con caja de insonorización (Incluye ruedas para facilitar su colocación y desplazamiento). Además, posee sistema de filtrado integrado, descarga electrocontrolada y un mantenimiento fácil y económico.

Cuenta con contador de horas, protección térmica y amperimétrica. Está equipado con **secador de membrana** incorporando un sistema de filtración de hasta 0,01 micras que garantiza un punto de rocío de hasta -20°C, lo que produce aire higiénico y libre de humedad.

Prime 2 genera mínimas vibraciones y con solo 66 dB/1m de nivel sonoro está entre **los más silenciosos del mercado**.

Referencia	Potencia	Voltaje	Caudal	Capacidad	Nivel de ruido	Peso	Dimensiones	Garantía	Precio
98-PROF200040M	1,5 kW	230 V	152 lt/min	40 L	66 dB	50 Kg	710x420x600 mm	24 +12 meses (Tras registrar producto)	2.398 <sup>00</sup> €
98-PRSK200040M (con cubierta insonorizada)					56 dB	54 Kg	710x460x890 mm		2.998 <sup>00</sup> €
98-PRCS200040M (con caja insonorizada)					53 dB	102 Kg	530x750x915 mm		3.738 <sup>00</sup> €

BAJO PEDIDO

BAJO PEDIDO

Si no encuentras la solución que buscas ¡CONSÚLTANOS!

SI NO ENCUENTRAS EL REPUESTO QUE BUSCAS, ¡CONSÚLTANOS!

Precios: impuestos, portes y mano de obra no incluidos.

**NOVEDAD**

Compresor

# PRIME 3

MGF Compressors



**POTENCIA Y DURABILIDAD  
EN UN DISEÑO  
SILENCIOSO Y COMPACTO**



**CON CAJA  
INSONORIZADA**



Prime es el máximo exponente de la gama: apto para uso intensivo, sistema de biela articulada y cilindro con camisa de latón para un deslizamiento óptimo y menor desgaste de los segmentos del pistón.

**Recogen lo mejor de la tecnología Prime**

**Prime 3** es la **versión de 3 cilindros**, disponible en configuración básica y con caja de insonorización (Incluye ruedas para facilitar su colocación y desplazamiento). Además, posee sistema de filtrado integrado, descarga electrocontrolada y un mantenimiento fácil y económico.

Cuenta con contador de horas, protección térmica y amperimétrica. Está equipado con **secador de membrana** incorporando un sistema de filtración de hasta 0,01 micras que garantiza un punto de rocío de hasta -20°C, lo que produce aire higiénico y libre de humedad.

Prime 3 genera mínimas vibraciones y con solo 66 dB/1m de nivel sonoro está entre **los más silenciosos del mercado**.

Referencia	Potencia	Voltaje	Caudal	Capacidad	Nivel de ruido	Peso	Dimensiones	Garantía	Precio
98-PROF300040M	2,2 kW	230 V	225 lt/min	40 L	66 dB	58 Kg	710x410x810 mm	24 +12 meses (Tras registrar producto)	<b>2.898<sup>00</sup> €</b>
98-PRCS300040M (con caja insonorizada)					53 dB	110 Kg	530x750x915 mm		<b>4.298<sup>00</sup> €</b>

**BAJO PEDIDO**

**Si no encuentras la solución que buscas ¡CONSÚLTANOS!**

# Zen1

## Aspir Comp & Metatower

Sistema compuesto por compresor y aspirador

**Potencia y durabilidad**  
en un diseño  
**silencioso y compacto**







# REPUESTOS COMPRESORES MGF®



## Kits de mantenimiento compresores MGF® Pime y Genesi

### Descripción

### Observaciones

NUEVO	 <small>Imagen no disponible</small>	<p>Kit mantenimiento anual, compresores MGF® <b>Genesi*</b></p> <p><b>Incluye:</b></p> <ul style="list-style-type: none"> <li>- 2x Filtro aspiración</li> <li>- Filtro cartucho reductor</li> <li>- Junta filtro</li> <li>- Disco válvula antiretorno</li> </ul> <p><b>Ref.: 98-080009</b> (Ref. MGF®: TA-FL-001-K = 2x MA-MF-00010 + TA-FL-001-C-SM + TA-FL-001-OR + CO-PV-001)</p> <p style="text-align: right;"><b>51<sup>80</sup>€</b></p>	<p>*Solo válido para versiones Genesi S y M SKR (Con cristales adsorbentes).</p>
NUEVO	 <small>Imagen no disponible</small>	<p>Kit mantenimiento anual con filtros de cartucho, compresores MGF® <b>Genesi*</b></p> <p><b>Incluye:</b></p> <ul style="list-style-type: none"> <li>- Filtro aspiración</li> <li>- Disco válvula antiretorno</li> <li>- Filtro de cartucho 5 µm (AF20)</li> <li>- Filtro de cartucho 0,01 µm (AFD20)</li> <li>- 2x Juntas de filtro (AF20, AFD20)</li> </ul> <p><b>Ref.: 98-080010</b> (Ref. MGF®: TA-FL-024-K-SCC = MA-MF00010 + CO-PV-001 + TA-FL-001-C-SM + TA-FL-024-C2-SM + 2x TA-FL-001-OR)</p> <p style="text-align: right;"><b>92<sup>80</sup>€</b></p>	<p>*Solo válido para versiones Genesi M con secador de membrana.</p>
NUEVO	 <small>Imagen no disponible</small>	<p>Kit mantenimiento de repuestos completo con placa de válvulas, compresores MGF® <b>Genesi</b></p> <p><b>Incluye:</b></p> <ul style="list-style-type: none"> <li>- Filtro aspiración</li> <li>- 2x Segmento pistón</li> <li>- 2x Placas de válvulas completo</li> <li>- Disco válvula antiretorno</li> <li>- Filtro cartucho reductor</li> </ul> <p><b>Ref.: 98-080011</b> (Ref. MGF®: MG-GC-011-K = MA-MF00010 + 2x HB-PC-001 + 2x MA-MG02002-C + CO-PV-001 + TA-FL-001-C)</p> <p style="text-align: right;"><b>130<sup>80</sup>€</b></p>	
NUEVO	 <small>Imagen no disponible</small>	<p>Kit mantenimiento anual, compresores MGF® <b>Prime 1*</b></p> <p><b>Incluye:</b></p> <ul style="list-style-type: none"> <li>- 3x Filtro aspiración</li> <li>- Filtro cartucho reductor</li> <li>- Junta filtro</li> <li>- Disco válvula antiretorno</li> </ul> <p><b>Ref.: 98-080018</b> (Ref. MGF®: TA-FL-001-K-SCP = 3x TA-FL-058-C + TA-FL-001-C-SM + TA-FL-001-OR + CO-PV-001)</p> <p style="text-align: right;"><b>51<sup>80</sup>€</b></p>	<p>*Solo válido para versiones Prime 1 S y M SKR (Con cristales adsorbentes).</p>
NUEVO	 <small>Imagen no disponible</small>	<p>Kit mantenimiento de filtros cartucho SYNTESI secador de membrana, compresores MGF® <b>Prime 2 y 3</b></p> <p><b>Incluye:</b></p> <ul style="list-style-type: none"> <li>- Filtros aspiración</li> <li>- Filtro de cartucho 5 µm (AF20)</li> <li>- Filtro de cartucho 0,01 µm (AFD20)</li> <li>- Junta filtro (AF20, AFD20)</li> <li>- Disco válvula antiretorno</li> <li>- Filtro de cartucho 5 µm (AF30)</li> <li>- Filtro de cartucho 0,01 µm (AFD30)</li> <li>- Cartucho separador agua (AMG150)</li> <li>- 2x Juntas filtro (AF30, AFD30)</li> </ul> <p><b>Ref.: 98-080019</b> (Ref. MGF®: TA-FL-026-K-SCP = 3x TA-FL-058-C + TA-FL-001-C-SM + TA-FL-024-C2-SM + 2x TA-FL-001-OR + CO-PV-001 + TA-FL-075-C + TA-FL-076-C + TA-FL-074-C + 2x TA-FL-075-OR)</p> <p style="text-align: right;"><b>121<sup>80</sup>€</b></p>	

NUEVO



**Descripción**

Kit mantenimiento de repuestos completo compresores MGF® **Prime 2\***

- Incluye:**
- 2x Filtros aspiración
  - 4x Juntas
  - 2x Segmento pistón
  - 2x Anillo ajustable
  - 2x Anillo elastico
  - 2x Placas de válvulas completo
  - Disco válvula antiretorno

**Ref.: 98-080020** (Ref. MGF®: PR-GC-031-K-SCP = 2x TA-FL-058-C + 4x MA-PC018 + 2x MA-MG00001 + 2x MA-MG00003 + 2x MA-MG00024 + 2x MA-MG-02002P-C-P + CO-PV-001)

**208<sup>00</sup>€**

**Observaciones**

\*Solo válido para versiones Prime 2 1,5 kW.

NUEVO



Kit mantenimiento de repuestos completo compresores MGF® **Prime 3\***

- Incluye:**
- 3x Filtros aspiración
  - 6x Juntas
  - 3x Segmento pistón
  - 3x Anillo ajustable
  - 3x Anillo elástico
  - 3x Placas de válvulas completo
  - Disco válvula antiretorno

**Ref.: 98-080021** (Ref. MGF®: PR-GC-032-K-SCP = 3x TA-FL-058-C + 6x MA-PC018 + 3x MA-MG00001 + 3x MA-MG00003 + 3x MA-MG00024 + 3x MA-MG-02002P-C-P + CO-PV-001)

**258<sup>00</sup>€**

\*Solo válido para versiones Prime 3 2,2 kW.

Repuestos compresores MGF® Pime y Genesi



NUEVO



**Descripción**

Condensador 35 µF, compresores MGF®

**Ref.: 98-080001** (Ref. MGF®: MG-CO-005)

**19<sup>80</sup>€**

**Observaciones**

**Potencia:** 0,75 kW.

NUEVO



Biela con rodamiento compresores MGF® **Genesi**

**Ref.: 98-080002** (Ref. MGF®: MG-PF-002-C)

**76<sup>80</sup>€**

NUEVO



Carcasa ventilador refrigeración, compresores MGF® **Genesi** de un cilindro (N/S > 07163100)

**Ref.: 98-080003** (Ref. MGF®: MA-MG00022-N)

**7<sup>10</sup>€**

Sin filtro.

NUEVO



Secador de aire, compresores MGF® **Genesi** y **Prime 1**

**Ref.: 98-080004** (Ref. MGF®: TA-ES-401)

**418<sup>00</sup>€**

NUEVO





















Conjunto de válvula de disparo 1/4", compresores MGF® **Genesi**









**Ref.: 98-080005** (Ref. MGF®:TA-SA-009)

**121<sup>80</sup>€**

- **Voltaje:** 230 V CA.
- Con temporizador de disparo.
- Cable de alimentación: 2 m.
- Válvula solenoide (Acción directa, normalmente cerrado, orificio Ø4 mm).

	Descripción	Observaciones
NUEVO	 Imagen no disponible Electroválvula dos vías 1/8", compresores MGF® <b>Genesi</b> Ref.: <b>98-080006</b> (Ref. MGF®: VA-EL-001-B)	Voltaje: 240 V 50/60 Hz. Normalmente abierta. 26´80€
NUEVO	 Imagen no disponible Presostato 4 vías G1/4", compresores MGF® <b>Genesi</b> Ref.: <b>98-080007</b> (Ref. MGF®: ME-PS-001)	36´80€
NUEVO	 Imagen no disponible Manómetro 1/8", compresores MGF® <b>Genesi</b> Ref.: <b>98-080008</b> (Ref. MGF®: RA-MM-001)	ø40 mm con montaje trasero. 7´10€
NUEVO	 Imagen no disponible Válvula de seguridad 1/4", compresores MGF® <b>Genesi</b> y <b>Prime 1, 2 y 3</b> Ref.: <b>98-080012</b> (Ref. MGF®: VA-SI-014)	-TA6. - Presión: 10,3 bar. - Con muelle de acero. 4´30€
NUEVO	 Imagen no disponible Válvula antiretorno, compresores MGF® <b>Genesi</b> y <b>Prime 1, 2 y 3</b> - 1/2" hembra x 3/8" macho x 1/8" hembra Ref.: <b>98-080013</b> (Ref. MGF®: VA-UN-001)	Niquelada. 10´30€
NUEVO	 Imagen no disponible Taco amortiguador vibraciones, compresores MGF® <b>Genesi</b> (N/S > 10153700) y <b>Prime 1</b> - 20 x 30mm, 10/18 - M8, Sh40 Ref.: <b>98-080014</b> (Ref. MGF®: TR-AV-012-1)	4´30€
NUEVO	 Imagen no disponible Ventilador MEC 90 con anillo de fijación, compresores MGF® <b>Genesi</b> Ref.: <b>98-080015</b> (Ref. MGF®: MA-PC004)	4´30€
NUEVO	 Imagen no disponible Cilindro extruido Ø60 mm x 65,8 mm, compresores MGF® <b>Genesi</b> Ref.: <b>98-080016</b> (Ref. MGF®: MG-ES001-L)	31´80€
NUEVO	 Imagen no disponible Unidad de bombeo, compresores MGF® <b>Genesi</b> Ref.: <b>98-080017</b> (Ref. MGF®: GC-150-GE-VI-V)	Potencia: 1,2 kW. Voltaje: 230V. Frecuencia: 50 Hz. 628´00€
NUEVO	 Imagen no disponible Condensador 35 µF, compresores MGF® <b>Prime 1*</b> Ref.: <b>98-080022</b> (Ref. MGF®: MA-CO-011)	*Solo válido para versiones Prime 1 hp. 7´10€

	Descripción	Observaciones
NUEVO	 Imagen no disponible Condensador 45 µF, compresores MGF® <b>Prime 2*</b> Ref.: <b>98-080023</b> (Ref. MGF®: MA-CO-010)	*Solo válido para versiones Prime 2 hp. 20'80€
NUEVO	 Imagen no disponible Condensador 55 µF, compresores MGF® <b>Prime 3*</b> Ref.: <b>98-080024</b> (Ref. MGF®: MA-CO-012)	*Solo válido para versiones Prime 3 hp. 10'30€
NUEVO	 Imagen no disponible Protección térmica 8A, compresores MGF® <b>Prime 1</b> Ref.: <b>98-080025</b> (Ref. MGF®: ME-TH-005)	10'30€
NUEVO	 Imagen no disponible Protección térmica 10A, compresores MGF® <b>Prime 2</b> Ref.: <b>98-080026</b> (Ref. MGF®: ME-TH-002)	10'30€
NUEVO	 Imagen no disponible Protección térmica 16A, compresores MGF® <b>Prime 3</b> Ref.: <b>98-080027</b> (Ref. MGF®: ME-TH-016)	12'40€
NUEVO	 Imagen no disponible Filtro aspiración completo con cubierta de plástico, compresores MGF® <b>Prime 1, 2 y 3</b> Ref.: <b>98-080028</b> (Ref. MGF®: TA-FL-058)	38'80€
NUEVO	 Imagen no disponible Manómetro 1/8", compresores MGF® <b>Genesi y Prime 1</b> Ref.: <b>98-080029</b> (Ref. MGF®: RA-MM-004)	ø40 mm con montaje radial. 7'10€
NUEVO	 Imagen no disponible Manómetro 1/4", compresores MGF® <b>Prime 2 y 3</b> Ref.: <b>98-080030</b> (Ref. MGF®: RA-MM-006)	ø50 mm con montaje trasero. 19'80€
NUEVO	 Imagen no disponible Manómetro 1/4", compresores MGF® <b>Genesi, Prime 2 y 3</b> Ref.: <b>98-080031</b> (Ref. MGF®: RA-MM-002)	ø50 mm con montaje trasero. 12'40€
NUEVO	 Imagen no disponible Copa sistema filtración 0,01 µm, 1/4", compresores MGF® <b>Genesi, Prime 2 y 3</b> Ref.: <b>98-080032</b> (Ref. MGF®: TA-FL-030-SM-T)	- Sin regulador de presión. - Semi-automático. 23'80€

	Descripción	Observaciones
NUEVO	 Imagen no disponible Manguera L300 de alta temperatura 3/8", compresores MGF® <b>Genesi</b> y <b>Prime 2 y 3</b> Ref.: <b>98-080033</b> (Ref. MGF®: TU-RAT-300)	12´40€
NUEVO	 Imagen no disponible Taco amortiguador vibraciones, compresores MGF® <b>Prime 2 y 3</b> (N/S > 10153700) - 30 x 40mm, 12/22 - M8, Sh40 Ref.: <b>98-080034</b> (Ref. MGF®: TR-AV-3040)	2´90€
NUEVO	 Imagen no disponible Secador de aire membrana 2A, compresores MGF® <b>Prime 2 y 3</b> Ref.: <b>98-080035</b> (Ref. MGF®: TA-ES-101)	Caudal: 140 lt/min. 698´00€
NUEVO	 Imagen no disponible Presostato 1 vía G1/4", compresores MGF® Ref.: <b>98-080036</b> (Ref. MGF®: ME-PS-002)	35´80€
NUEVO	 Imagen no disponible Carcasa ventilador refrigeración, compresores MGF® <b>Prime 2</b> de dos cilindros (N/S > 07163100) Ref.: <b>98-080037</b> (Ref. MGF®: MA-MG00020P-N)	22´80€
NUEVO	 Imagen no disponible Carcasa ventilador refrigeración, compresores MGF® <b>Prime 3</b> de tres cilindros (N/S > 07163100) Ref.: <b>98-080038</b> (Ref. MGF®: MA-MG00027P-N)	12´40€
NUEVO	 Imagen no disponible Cigüeñal completo con pistón, compresores MGF® <b>Prime 3</b> Ref.: <b>98-080039</b> (Ref. MGF®: MA-MG03003-E-C)	74´80€
NUEVO	 Imagen no disponible Cigüeñal completo con pistón y manivela, compresores MGF® <b>Prime 1, y 2*</b> (N/S > 07163100) Ref.: <b>98-080040</b> (Ref. MGF®: MA-MG03003-E-C1)	*También utiliza pistón Ref. 98-080041 103´80€
NUEVO	 Imagen no disponible Cigüeñal completo con pistón y manivela zamak, compresores MGF® <b>Prime 2*</b> (N/S > 07163100) Ref.: <b>98-080041</b> (Ref. MGF®: MA-MG03003-C-Z)	*También utiliza pistón Ref. 98-080040 Sin volante. 104´80€

# REPUESTOS COMPRESORES DÜRR®

## Compresores DÜRR® PRIMO, DUO, TRIO Y CUATRO



	Descripción	Observaciones
	Kit reparación compresor 51 / 52 (PRIMO, DUO, TRIO y CUATRO). Ref.: <b>68-11101</b> (Ref. Dürr®: 5110.992.00)	<b>Incluye:</b> 5150.981.00 kit juntas culata, 5110.105.50 culata 250'80€
	Filtro compresor 51 / 52 (PRIMO, DUO, TRIO y CUATRO). Ref.: <b>68-11102</b> (Ref. Dürr®: 0832.982.00)	59'80€
	Junta tórica culata tapón filtro amarillo compresor 51 / 52 (PRIMO, DUO, TRIO y CUATRO). Ref.: <b>68-11103</b> (Ref. Dürr®: R9000.402.12)	9'80€

NUEVO

## Compresores DÜRR® Tornado 70 / 130





	Descripción	Observaciones
	Filtro redondo compresor Tornado 70 / 130. Ref.: <b>68-13101</b> (Ref. Dürr®: 5430.982.00)	37'80€
	Kit reparación compresor Tornado 70 / 130. Ref.: <b>68-13102</b> (Ref. Dürr®: 5430.981.00)	<b>Incluye:</b> Cilindro, aro compresión, tornillo pistón y 2 juntas culata. 260'80€
	Filtro + Porta filtro redondo compresor Tornado 70 / 130. Ref.: <b>68-13103</b> (Ref. Dürr®: 0852.001.00)	68'80€
	Biela + pistón compresor Tornado 70 / 130. Ref.: <b>68-13104</b> (Ref. Dürr®: 5430.984.00)	599'80€

## Compresores DÜRR® Tornado T1 y T2





	Descripción	Observaciones
	Juego filtros compresor Tornado T1 y T2. Ref.: <b>68-15101</b> (Ref. Dürr®: 5180.980.60)	<b>Incluye:</b> 1610.121.00 filtro anual superior, 1650200323 filtro secador membra- na 1650 / sinterizado, 5180.982.00 filtro admisión. 153'80€
	Filtro admisión compresor Tornado T1 y T2. Ref.: <b>68-15104</b> (Ref. Dürr®: 5180.982.00)	54'80€
	Kit reparación juntas cilindro compresor Tornado T1 y T2. Ref.: <b>68-15102</b> (Ref. Dürr®: 5180.981.00)	<b>Incluye:</b> Junta interior, aro compresión pistón, tornillo sujeción aro de compresión. 78'00€
	Presostato compresor Tornado T1 y T2. Ref.: <b>68-15103</b> (Ref. Dürr®: 5180.011.00E)	214'80€

	Descripción	Observaciones
NUEVO	 Válvula de descarga compresor Tornado T1 y T2 Ref.: <b>68-15105</b> (Ref. Dürr®: R9000.301.73)	<b>68<sup>00</sup>€</b>
NUEVO	 Válvula de descarga compresor Silver Airline New Ref.: <b>68-15106</b> (Ref. Dürr®: R9000.301.66)	<b>63<sup>80</sup>€</b>

Secadores DÜRR®



	Descripción	Observaciones
	Filtro secador todos los modelos. Ref.: <b>68-18101</b> (Ref. Dürr®: 1610.121.00)	<b>69<sup>80</sup>€</b>
	Filtro secador membrana 1650 / Sinterizado + Colector + Anillo tórico. Ref.: <b>68-18103</b> (Ref. Dürr®: 1650100147) (Antigua: 165010100)	<b>71<sup>80</sup>€</b>
	Filtro HEPA secador todos los modelos. Ref.: <b>68-18104</b> (Ref. Dürr®: 1650100172) (Antigua 1640.981.00)	<b>244<sup>80</sup>€</b>

SAR

## ▶ SISTEMAS DE ASPIRACIÓN Y REPUESTOS

- Motores aspiración Luzzani® Dental y repuestos
- Motores aspiración, centrifugadoras y separadores de amalgama METASYS®
- Válvulas y accesorios METASYS®
- Repuestos aspiraciones METASYS®
- Conectores META connect (METASYS®)
- Centrifugadoras y repuestos aspiraciones Dürr® Dental
- Conectores Dürr Connect®
- Mangueras y tubos aspiración
- Terminales de aspiración y adaptadores



Repuestos



# MOTORES ASPIRACIÓN LUZZANI® DENTAL Y SUS REPUESTOS

## Motor de aspiración seca AIRMATIC



- Máxima fiabilidad + Máximo silencio.
- Puede funcionar de forma continuada.
- Depresión estática: 1.300 mm de agua aprox.
- Caudal de aire: 1.200 l/min.

- Funcionamiento: aspiración y compresión.
- Ausencia completa de ruido.
- **Garantía:** 1 año.

### MOTOR ASÍNCRONO MONOFÁSICO

Tensión alimentación	220V / 50Hz
Potencia de absorción	Wa 415
Absorción	A 1,86
Condensación	μ F10
Cos φ	0,96
Velocidad de rotación	2.810 rpm
Modo de trabajo	Continuo
Depresión estática	1.300 mm de agua
Caudal de aire	1.200 l/min.

### DIAGRAMA DE DEPRESIÓN

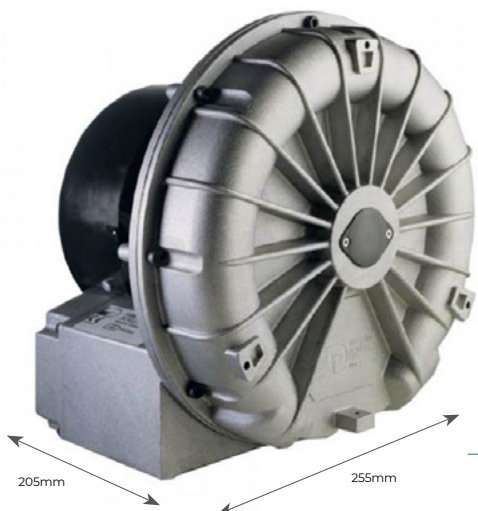
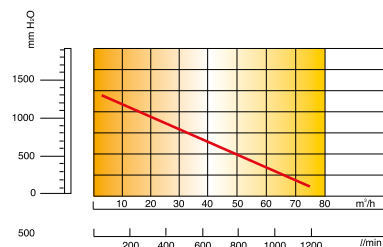

Ref.: **39-8AIRMAT**

**478<sup>00</sup>€**

## Repuestos motor de aspiración seca AIRMATIC

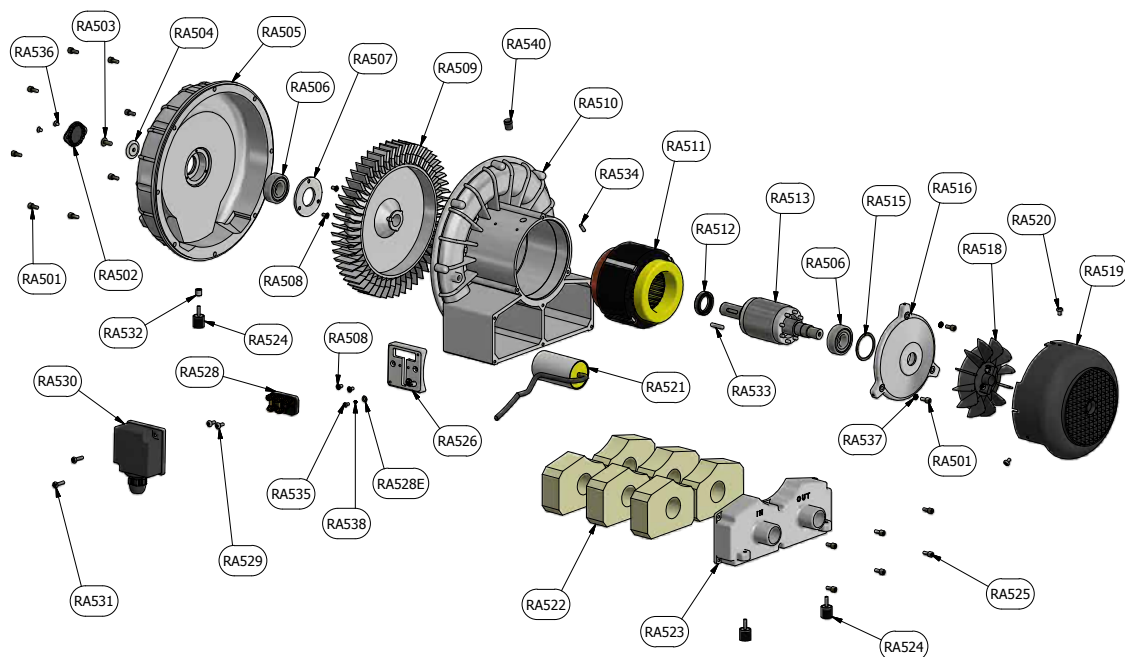

### Descripción

### Observaciones

	Rodamientos (RA506)	<b>Ref.: 39-8RA506</b>	<b>21<sup>80</sup>€</b>
	Silenciadores (RA522)	<b>Ref.: 39-8RA522</b>	<b>21<sup>80</sup>€</b>

# MOTORES ASPIRACIÓN, CENTRIFUGADORAS Y SEPARADORES DE AMALGAMA METASYS®

Motores de aspiración METASYS®



## Rotor separador centrífugo

Módulo separador que, gracias a su fuerza centrífuga, garantiza una separación continua y perfecta incluso con grandes cargas de espuma. Para que la bomba de vaciado funcione de por vida, la fiabilidad de la separación debe estar garantizada.



## Desagüe de las aguas residuales más alto

Un desagüe de aguas residuales colocado más alto permite una conexión cómoda con el desagüe o el separador de amalgama. Con ello ya no se requiere ninguna otra instalación para una posible elevación necesaria del aparato de aspiración.

## Regulación de presión negativa controlada por frecuencia\*

Según los requisitos de potencia, la regulación de la presión negativa se realiza mediante un control de frecuencia que proporciona a las cánulas una gran presión negativa constante de 180 mbar. Además, la función controlada por frecuencia reduce considerablemente el consumo energético.  
\* Solo para EXCOM Hybrid 5

## Un eje de motor

Un eje de motor para mover tanto el generador de presión negativa como la separación, al mismo tiempo que permite el funcionamiento simultáneo de ambos módulos. Esto impide el peligro de un posible derrame de líquido provocado por una separación que no esté funcionando dentro de una bomba de vacío en marcha.

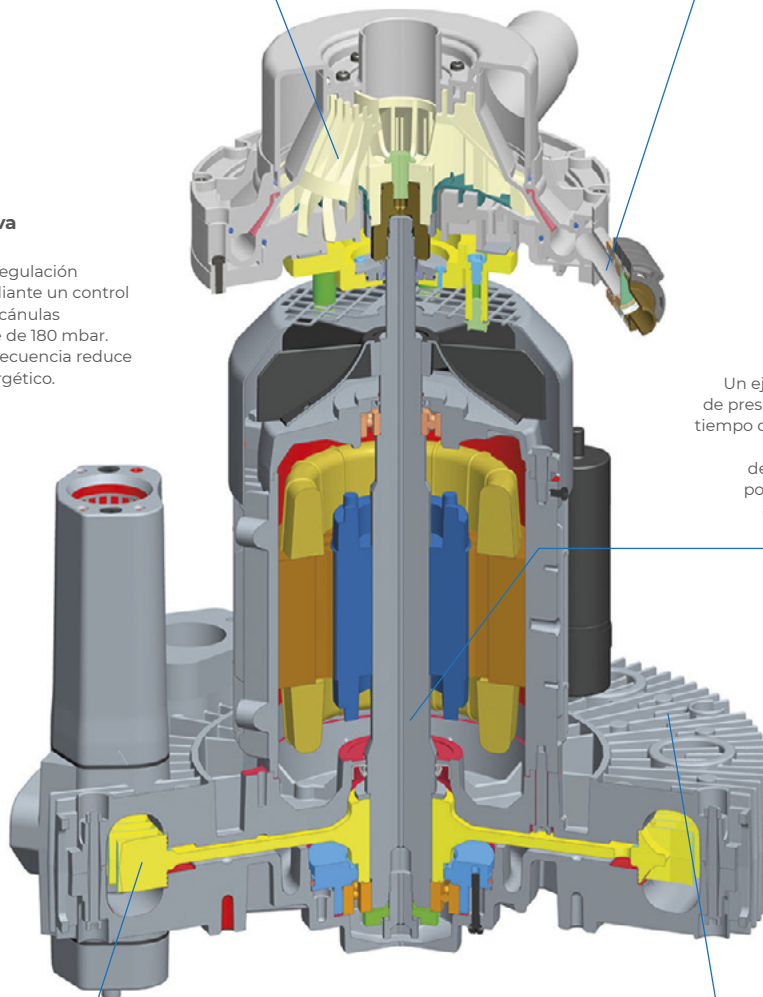

## Rueda de turbina de aluminio

La rueda de turbina de aluminio de marcha libre garantiza la seguridad del funcionamiento a largo plazo. No se utilizan ruedas de plástico.

## Aletas de refrigeración que optimizan el caudal de aire

El diseño especial de estas aletas optimizadas garantiza una mejor refrigeración y una mayor protección contra el sobrecalentamiento. El caudal de aire y refrigeración eficiente que proporcionan estas aletas de refrigeración permite un rápido descenso del calor.

## Garantía de 36 meses\*

\*Excepto el EXCOM Hybrid 1, que tiene una garantía de 24 meses.

# MOTORES ASPIRACIÓN HÍBRIDA (HÚMEDA Y SECA) CENTRALIZADOS SIN SEPARACIÓN AMALGAMA

Motores de aspiración híbrida METASYS® sin separador de amalgama



EXCOM Hybrid 1S



EXCOM Hybrid 1



EXCOM Hybrid 2



EXCOM Hybrid 5

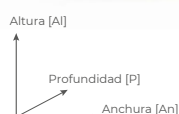

	EXCOM Hybrid 1S	EXCOM Hybrid 1	EXCOM Hybrid 2	EXCOM Hybrid 5
Tensión de alimentación	230 V AC	230 V AC	230 V AC	230 V AC / 400 V AC
Frecuencia	50 / 60 Hz	50 / 60 Hz	50 / 60 Hz	50 / 60 Hz
Consumo máx. corriente	3,5 / 4,5 A	6,7 A	6,7 A	9,0 / 10,0 A // 4,3 / 4,4 A
Consumo máx. potencia	0,55 / 0,63 kW	0,94 / 1,1 kW	1,1 / 1,3 kW	1,5 / 1,75 kW
Temperatura máx. ambiente	40° C	40° C	40° C	40° C
Volumen aspiración	1.100 l/min	1.100 / 1.300 l/min	1.450 / 1.750 l/min	2.000 / 2.400 l/min
Zona presión negativa regulada	120 / 140 mbar	180 mbar	180 mbar	180 mbar
Nivel sonoro	63 dB (A)	57 / 62 dB (A)	58 / 63 dB (A)	64 / 68 dB (A)
Dimensiones (Al x An x P) en mm	530 x 350 x 320	570 x 422 x 400	580 x 450 x 400	620 x 460 x 455
Peso	15 Kg	22 kg	27 kg	30 kg
Duración conexión	100%	100%	100%	100%
Tasa separación	-	-	-	-
Número de equipos	1 equipo	Hasta 2 equipos	Hasta 3 equipos	Hasta 5 equipos
Suministro incluye	Kit básico instalación* (excepto tubo desahogo)	Kit básico instalación*	Kit básico instalación*	Kit básico instalación*
Garantía	24 meses**	36 meses**	36 meses**	36 meses**

\* Incluye: 1m. tubo desahogo, 1m. tubo entrada y kit básico de adaptadores para la instalación.

\*\* Mínimo de mantenimiento requerido. **Consultar**

**OFERTAS ESPECIALES DISTRIBUIDORES ¡Consúltanos!**

Descripción	Observaciones
EXCOM Hybrid 1S, con unidad de control <b>Ref.: 98-010154</b> (Ref. Metasys®: 104000002 / 02010154)	1 equipo <b>1.398<sup>00</sup>€</b>
EXCOM Hybrid 1, con unidad de control <b>Ref.: 98-010311</b> (Ref. Metasys®: 104000005 / 02010311)	Hasta 2 equipos <b>1.800<sup>00</sup>€</b>
EXCOM Hybrid 2, con unidad de control <b>Ref.: 98-010312</b> (Ref. Metasys®: 104000006 / 02010312)	Hasta 3 equipos <b>2.680<sup>00</sup>€</b>
EXCOM Hybrid 5 (230 V), con unidad de control <b>Ref.: 98-010313</b> (Ref. Metasys®: 104000008 / 02010313)	Hasta 5 equipos <b>4.280<sup>00</sup>€</b> <b>BAJO PEDIDO</b>
EXCOM Hybrid 5 (400 V), con unidad de control <b>Ref.: 98-010314</b> (Ref. Metasys®: 104000009 / 02010314)	Hasta 5 equipos <b>4.388<sup>00</sup>€</b> <b>BAJO PEDIDO</b>

# MOTORES ASPIRACIÓN HÍBRIDA (HÚMEDA Y SECA) CENTRALIZADOS CON SEPARACIÓN AMALGAMA

Motores de aspiración híbrida METASYS® con separador de amalgama

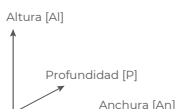

	EXCOM Hybrid A1	EXCOM Hybrid A2	EXCOM Hybrid A5
Tensión de alimentación	230 V AC	230 V AC	230 V AC / 400 V AC
Frecuencia	50 / 60 Hz	50 / 60 Hz	50 / 60 Hz
Consumo máx. corriente	6,7 A	6,7 A	9,0 / 10,0 A // 4,3 / 4,4 A
Consumo máx. potencia	0,94 / 1,1 kW	1,1 / 1,3 kW	1,5 / 1,75 kW
Temperatura máx. ambiente	40° C	40° C	40° C
Volumen aspiración	1.100 / 1.300 l/min	1.450 / 1.750 l/min	2.000 / 2.400 l/min
Zona presión negativa regulada	180 mbar	180 mbar	180 mbar
Nivel sonoro	57 / 62 dB (A)	58 / 63 dB (A)	64 / 68 dB (A)
Dimensiones (Al x An x P) en mm	570 x 422 x 400	580 x 450 x 400	620 x 460 x 455
Peso	24,5 kg	29,5 kg	35 kg
Duración conexión	100%	100%	100%
Tasa separación	99,30%	99,30%	99,30%
Número de equipos	Hasta 2 equipos	Hasta 3 equipos	Hasta 5 equipos
Suministro incluye	Kit básico instalación*	Kit básico instalación*	Kit básico instalación*
Garantía	36 meses**	36 meses**	36 meses**

\* Incluye: 1m tubo deshaogo, 1m tubo entrada , kit básico de adaptadores para la instalación + kit instalación separador de amalgama

\*\* Mínimo de mantenimiento requerido. **Consultar**

**OFERTAS ESPECIALES  
DISTRIBUIDORES  
¡Consúltanos!**

Descripción		Observaciones
<b>Opcional EXCOM Hybrid 1S + Separador de amalgama ECO II+</b>		1 equipo
<b>Ref.: 98-010154 + 98-010004</b>		
EXCOM Hybrid A1-ECO II+, con unidad de control	<b>2.380<sup>00</sup>€</b>	Hasta 2 equipos
<b>Ref.: 98-010251</b> (Ref. Metasys®: 104000011 / 02010251)		
EXCOM Hybrid A2-ECO II+, con unidad de control	<b>3.080<sup>00</sup>€</b>	Hasta 3 equipos
<b>Ref.: 98-010221</b> (Ref. Metasys®: 104000012 / 02010221)		
EXCOM Hybrid A5 (230 V) – ECO II+, con unidad de control	<b>4.680<sup>00</sup>€</b>	Hasta 5 equipos
<b>Ref.: 98-010222</b> (Ref. Metasys®: 104000014 / 02010222)		<b>BAJO PEDIDO</b>
EXCOM Hybrid A5 (400 V) – ECO II+, con unidad de control	<b>4.788<sup>00</sup>€</b>	Hasta 5 equipos
<b>Ref.: 98-010224</b> (Ref. Metasys®: 104000015 / 02010224)		<b>BAJO PEDIDO</b>

SI NO ENCUENTRAS EL REPUESTO QUE BUSCAS, ¡CONSÚLTANOS!  
Precios: impuestos, portes y mano de obra no incluidos.

# CUBIERTAS INSONORIZADORAS MOTORES ASPIRACIÓN METASYS®

Cubiertas insonorizadoras METASYS®



Reduce el  
**nivel sonoro**  
un **15%**



### Descripción

Cubierta insonorizadora para EXCOM Hybrid 1s - sin ventilador

Ref.: **98-110007** (Ref. Metasys®: 120000518 / 40030007)

**388<sup>00</sup>€**

### Observaciones

Reducción nivel sonoro 15%

**BAJO PEDIDO**

Cubierta insonorizadora para EXCOM Hybrid 1, 2, 5, A1, A2 y A5 - con ventilador

Ref.: **98-110004** (Ref. Metasys®: 120000521 / 40030004)

**1.288<sup>00</sup>€**

Reducción nivel sonoro 15%

**BAJO PEDIDO**

## NUEVO SEPARADOR DE AMALGAMA

Separador de amalgama METASYS®



### AHORA mejor:

- Admite picos de caudal de agua de hasta **2,7 l/min**
- Instalación rápida **Plug & Play**:  
reemplazo más rápido, sencillo y seguro



**ECO II+**

	ECO II +
Caudal máx. agua	1 l/min (Soporta picos de hasta 2,7 l/min)
Tasa separación	99,38%
Volumen recipiente colector	700 cm <sup>3</sup>
Intervalo de cambio	Anual / lleno 100%
Dimensiones (Al x An x P) en mm	308 x 164 x 201 mm
Peso en vacío con soporte / contenedor lleno	1,7 kg / 2,7 kg
Suministro incluye	Kit básico instalación

Desde el 1 de enero de 2019 los operadores de los gabinetes dentales que utilicen amalgama dental, que retiren empastes de amalgama dental, o extraigan dientes que contengan dichas amalgamas, **deben contar con separadores de amalgama** (deben garantizar un nivel de retención de, como mínimo, el 95 % de las partículas de amalgama) para retener y recoger las partículas de las mismas, incluidas las contenidas en el agua usada.

**OFERTAS ESPECIALES  
DISTRIBUIDORES  
¡Consúltanos!**

### Descripción

ECO II+

Ref.: **98-010004** (Ref. Metasys®: 101000024)

**780<sup>00</sup>€**

### Observaciones

Sustituye a Ref. 101000015 / antigua Ref. 01050004 descatálogada

# CENTRIFUGADORAS METASYS®

Centrifugadoras METASYS®



MST 1 ECO LIGHT

MST 1

COMPACT Dynamic

MST 1  
(Modelo externo)

	MST 1 ECO LIGHT	MST 1	COMPACT Dynamic
Separación de amalgama	No	Si	Si
Sistema de Autolimpieza	-	Si	Si
Tensión de alimentación	24 V AC	24 V AC	24 V AC
Frecuencia	50 / 60 Hz	50 / 60 Hz	50 / 60 Hz
Consumo máx. corriente	1,5 A	2 A	6,3 A
Consumo máx. potencia	46 VA	46 VA	100 VA
Caudal máx. agua	4,5 l/min	4,5 l/min	4,5 l/min
- desde escupidera	3,0 l/min	3,0 l/min	3,0 l/min
- desde línea de aspiración	1,5 l/min	1,5 l/min	1,5 l/min
Zona presión negativa regulada	50-250 mbar	80-250 mbar	80-160 mbar
Tasa separación	-	98,6%	96,4%
Volumen recipiente colector	300 cm <sup>3</sup>	300 cm <sup>3</sup>	300 cm <sup>3</sup>
Dimensiones (Al x An x P) en mm	305 x 163 x 104mm	305 x 210 x 104mm	301 x 173 x 110mm
Suministro incluye	Kit básico instalación	Kit básico instalación	Kit básico instalación
<b>Garantía</b>	36 meses*	36 meses*	36 meses*

\*Mínimo de mantenimiento requerido. **Consultar**

## Descripción

## Observaciones

MST 1 ECO LIGHT **sin separador de amalgama**Ref.: **98-010033** (Ref. Metasys®: 13000001 / 01010033)**898<sup>00</sup>€**MST 1 **con separador de amalgama**Ref.: **98-010001** (Ref. Metasys®: 101000001 / 01010001)**2.098<sup>00</sup>€**MST 1 **con separador de amalgama**Ref.: **98-010020** (Ref. Metasys®: 101000007 / 01010020)**2.480<sup>00</sup>€**

Modelo externo

**BAJO PEDIDO**COMPACT Dynamic **con separador de amalgama**Ref.: **98-110001** (Ref. Metasys®: 101000026 / 01060001)**2.198<sup>00</sup>€**

# MANTENIMIENTO, REPUESTOS Y ACCESORIOS

## Válvulas



### Válvula escupidera

### Válvulas selectoras

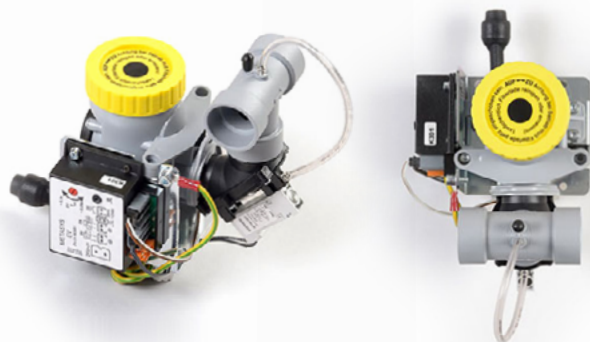

	Descripción	Observaciones
	Válvula escupidera <b>24 V DC / AC</b>  <b>Ref.: 98-020002</b> (Ref. Metasys®: 110000002 / 40050002)	<b>Garantía:</b> 12 meses  <b>498<sup>00</sup>€</b>
	Filtro cesta Metasys MST1, A8 y escupidera  <b>Ref.: 98-030002F</b> (Ref. Metasys®: 120000212 / 55010002)	<b>Pack:</b> 10 unidades  <b>118<sup>00</sup>€</b>
	Válvula selectora <b>24 DC / CC</b>  <b>Ref.: 98-020048</b> (Ref. Metasys®: 110000004 / 40050048)	<b>113<sup>80</sup>€</b>
	Válvula selectora <b>24 DC / CC y 24 AC / CA*</b>  <b>Ref.: 98-020044</b> (Ref. Metasys®: 110000005 / 40050044)	*98-020044 = 98-020048 + complemento que la hace AC / CA. (El complemento se puede utilizar o no).  <b>158<sup>00</sup>€</b>
	Membrana válvula selectora Metasys® y tornillos  <b>Ref.: 98-010003</b>	<b>19<sup>80</sup>€</b>

## REPUESTOS MOTORES ASPIRACIÓN

### Repuestos motores aspiración



	Descripción	Observaciones
	Aspa y tapa superior (Centrifuga) Motores METASYS® EXCOM Hybrid 1, 2, 5, A1, A2 y A5 <b>Ref.: 98-010210</b> (Ref. Metasys®: 120000625 / 50060210 + aspa)	668 <sup>00</sup> €
	Filtro entrada motores METASYS EXCOM Hybrid <b>Ref.: 98-010467</b> (Ref. Metasys®: 120000467 / 55010010)	78 <sup>80</sup> €

## KITS MANTENIMIENTO MOTORES ASPIRACIÓN

### Kits mantenimiento motores aspiración



	Descripción	Observaciones
	Kit mantenimiento anual motores METASYS® EXCOM Hybrid 1, 2, A1 y A2 <b>Ref.: 98-010240</b> (Ref. Metasys®: 120000527 / 50060240)	<b>Incluye:</b> Colector de agua con válvula antiretorno, conexión adaptador para separación y tubo PVC 177 <sup>80</sup> €

## KITS MANTENIMIENTO CENTRIFUGADORAS

### Kits mantenimiento centrifugadoras





	Descripción	Observaciones
	Kit inspección anual centrifugadora MST 1 <b>Ref.: 98-010109</b> (Ref. Metasys®: 120000235 / 50020109)	<b>Incluye:</b> Cuerpo básico de entrada con válvula antiretorno integrada, membrana válvula selectora, filtro bomba, contenedor reemplazo.
	Kit inspección 5 años centrifugadora MST 1 <b>Ref.: 98-010110</b> (Ref. Metasys®: 120000229 / 50020110)	<b>Incluye:</b> Cuerpo básico de entrada con válvula antiretorno integrada, membrana válvula selectora, filtro bomba, contenedor reemplazo, cajón de filtro, tapa centrifugadora, anillo desplazamiento agua, deflector de aire, cámara de centrifugado y tapa bomba centrifugado. 468 <sup>00</sup> € <span style="float: right; border: 1px solid black; padding: 2px;">BAJO PEDIDO</span>
	Kit inspección anual centrifugadora COMPACT Dynamic y COMPACT Dynamic ECO <b>Ref.: 98-010030</b> (Ref. Metasys®: 120000598 / 50040030)	<b>Incluye:</b> Rotor completo, junta, parte superior separador con membrana y contenedor reemplazo. 298 <sup>00</sup> €
	Kit inspección 5 años centrifugadora COMPACT Dynamic <b>Ref.: 98-010031</b> (Ref. Metasys®: 120000594 / 50040031)	<b>Incluye:</b> Rotor completo, junta, parte superior separador con membrana y contenedor reemplazo + centrifugadora y filtro bomba. 380 <sup>00</sup> € <span style="float: right; border: 1px solid black; padding: 2px;">BAJO PEDIDO</span>
	Kit inspección anual centrifugadora MST 1 ECO Light <b>Ref.: 98-010119</b> (Ref. Metasys®: 120000249 / 50020119)	<b>Incluye:</b> Anillo desplazamiento agua, deflector aire, alojamiento entrada bomba, membrana, válvula antiretorno, anillo tórico. 148 <sup>00</sup> €

## CONTENEDORES SEPARADORES DE AMALGAMA

### Contenedores separadores de amalgama





	Descripción	Observaciones
	Contenedor reemplazo MST 1 <b>Ref.: 98-210001</b> (Ref. Metasys®: 113000054 / 55020001) <b>50´80€</b>	
	Contenedor reemplazo COMPACT Dynamic <b>Ref.: 98-010005</b> (Ref. Metasys®: 113000013 / 55020005) <b>48´00€</b>	
	Contenedor reemplazo ECO II+, ECO II y ECO II Tandem <b>Ref.: 98-010130</b> (Ref. Metasys®: 113000077) <b>308´00€</b>	Sustituye al antiguo modelo (Ref. Metasys®: 113000034 / 55020130)

## TUBO ENTRADA ASPIRACIONES

### Tubo entrada aspiraciones





	Descripción	Observaciones
	Tubo de entrada de aire de sistemas de aspiración <b>Ref.: 98-020050</b> (Ref. Metasys®: 120000106 / 40300050) <b>42´80€</b>	<b>Diámetro:</b> 40mm <b>BAJO PEDIDO</b> <b>Por metro</b> Compra mínima 1 metro referencia Múltiplos de 1m, NO fracciones)
	Tubo de entrada de aire de sistemas de aspiración <b>Ref.: 98-020051</b> (Ref. Metasys®: 120000105 / 40300051) <b>48´00€</b>	<b>Diámetro:</b> 50mm <b>Por metro</b> Compra mínima 1 metro referencia Múltiplos de 1m, NO fracciones)

## TUBO DESAHOGO ASPIRACIONES

### Tubo desahogo aspiraciones



	Descripción	Observaciones
	Tubo <b>termo resistente</b> para descarga / desahogo de aire de sistemas de aspiración <b>Ref.: 98-020100</b> (Ref. Metasys®: 120000109 / 40300100) <b>82´80€</b>	<b>Diámetro:</b> 32mm <b>Por metro</b> Compra mínima 1 metro referencia Múltiplos de 1m, NO fracciones) Máximo 4m por tramo
	Tubo <b>termo resistente</b> para descarga / desahogo de aire de sistemas de aspiración <b>Ref.: 98-020101</b> (Ref. Metasys®: 120000108 / 40300101) <b>87´80€</b>	<b>Diámetro:</b> 40mm <b>Por metro</b> Compra mínima 1 metro referencia Múltiplos de 1m, NO fracciones) Máximo 4m por tramo
	Tubo <b>termo resistente</b> para descarga / desahogo de aire de sistemas de aspiración <b>Ref.: 98-020102</b> (Ref. Metasys®: 120000107 / 40300102) <b>93´80€</b>	<b>Diámetro:</b> 50mm <b>Por metro</b> Compra mínima 1 metro referencia Múltiplos de 1m, NO fracciones) Máximo 4m por tramo

# FILTROS SALIDA ASPIRACIONES HEPA H14

## Filtros salida aspiraciones HEPA H14

RUMAR

- Filtro **HEPA** (High Efficiency Particulate Air) con nivel de filtración H14 (99,995%)
- Adaptable a todos los sistemas de aspiración dental, fácil de instalar y mantener
- Apto para **hasta 5 sillones dentales** (144 m<sup>3</sup>/h)
- Instalable al final o en la línea de la salida de aire
- Frecuencia de **cambio de cartucho recomendada**: 24 meses
- Material: microfibra HEPA H14

**- Suministro incluye:**



- Filtro con cartucho
- Tubo desahogo termoresistente (80cm aprox.) Ø40mm
- Espigas PVC: 2uds. 1,0" x Ø30mm
- 2uds. 1 1/4" x Ø40mm
- Adaptadores PVC: 2uds. 1 1/4" x 1,0"
- Abrazaderas metálicas: 2uds. para Ø30mm
- 2uds. para Ø40mm



Filtra el **99,99%** de la materia fina suspendida



Separación Flujo nominal de aire (m <sup>3</sup> /h)	ENTRADA A	SALIDA B	ENTRADA A (mm)	SALIDA B (mm)	C (mm)	D (mm)	Øe (mm)	H (mm)	PESO (Kg)
144	G1 1/4 "	G1 1/4 "	38	38	95	98	173	156	1,7

Descripción	Observaciones
 <p>Filtro salida aspiraciones HEPA H14 completo</p> <p>Ref.: <b>98-030011</b> <b>341<sup>80</sup>€</b></p>	
 <p>Cartucho interno repuesto filtro salida aspiraciones HEPA H14</p> <p>Ref.: <b>98-030011C</b> <b>166<sup>80</sup>€</b></p>	

# CONECTORES META CONNECT - DÜRR CONNECT

## Conectores Meta Connect



	Descripción	Observaciones
	Adaptador Dürr® Connect <b>(G)</b> - META Connect <b>Ref.: 98-040124</b> (Ref. Metasys®: 120000084 / 40010124)	<b>Macho - Macho</b> 1 unidad <b>15'80€</b>
	Adaptador Dürr® Connect <b>(K)</b> - META Connect <b>Ref.: 98-040084</b> (Ref. Metasys®: 120000285 / 40010084)	<b>Macho - Macho</b> 1 unidad <b>16'80€</b>
	Adaptador Dürr® Connect <b>(K)</b> - META Connect <b>Ref.: 98-040102</b> (Ref. Metasys®: 120000286 / 40010102)	<b>Hembra - Hembra</b> 1 unidad <b>16'80€</b>
	Adaptador conexión Ø Interno 27mm X Ø Exterior 32mm - META Connect <b>Ref.: 98-040125</b> (Ref. Metasys®: 120000087 / 40010125)	<b>Macho - Macho</b> 1 unidad <b>15'80€</b>
	Clip cierre META Connect <b>Ref.: 98-040103</b> (Ref. Metasys®: 120000274 / 40010103)	1 unidad <b>12'80€</b>

# LIMPIEZA ASPIRACIONES

Limpiador, desinfectante y desodorizante GREEN & CLEAN®

**METASYS**

Doble concentrado desespumado activo para la limpieza diaria, desinfección y desodorización de sistemas de aspiración y separadores de amalgama.

- Apto para el mantenimiento de aspiraciones de **todas las marcas**.
- Concentrado: fácil de transportar y no ocupa espacio.
- Sistema dual especialmente diseñado para impedir la generación de microorganismos resistentes.
- Extremadamente **cómodo** y **sencillo**.

Apto para el mantenimiento de  
**TODAS LAS MARCAS**



## Modo de empleo

<ol style="list-style-type: none"> <li>1. Accionar dos veces la bomba dosificadora (= 6 ml de concentrado)</li> <li>2. Llenar el recipiente con agua hasta la marca (= 600 ml solución al 1%)</li> <li>3. Colocar la cánula pequeña en el orificio marcado con 1 hasta que se aspire aire (200 ml)</li> </ol>	<ol style="list-style-type: none"> <li>4. Colocar la cánula grande en el orificio marcado con 2 hasta que se aspire aire (200 ml)</li> <li>5. Vaciar el líquido restante en la taza de la escupidora (200 ml)</li> <li>6. Esperar el tiempo de actuación y luego enjuagar (60 min para HBV/HIV/HCV, tuberculida)</li> </ol>				

	Descripción	Observaciones
	Kit iniciación Green & Clean® M2 <b>Ref.: 98-030201</b> (Ref. Metasys®: 122000026 / 60010201)	<b>Incluye:</b> 1 x dispensador 1 x M2 rojo 500ml 1 x M2 verde 500ml Aproximadamente <b>167 aplicaciones</b> <b>= Más de 4 meses de mantenimiento</b>
	Kit refill I Green & Clean® M2 <b>Ref.: 98-030202</b> (Ref. Metasys®: 122000027 / 60010202)	<b>Incluye:</b> 2 x M2 rojo 500ml 2 x M2 verde 500ml Aproximadamente <b>334 aplicaciones</b> <b>= Más de 8 meses de mantenimiento</b>
	Kit refill II Green & Clean® M2 <b>Ref.: 98-030203</b> (Ref. Metasys®: 122000028 / 60010203)	<b>Incluye:</b> 1 x M2 rojo 500ml 1 x M2 verde 500ml Aproximadamente <b>167 aplicaciones</b> <b>= Más de 4 meses de mantenimiento</b>

## LIMPIEZA BIOFILM SILLONES

### Limpiador Biofilm líneas agua sillones



MÁS BAJO

- Diseñado para que al menos una vez al año el servicio técnico haga una limpieza integral de las líneas de agua limpia de los sillones dentales.
- Muy sencillo de utilizar por servicios técnicos.
- Unos pocos sencillos pasos, y una hora de actuación, para que toda la red de tubos de agua limpia del sillón dental, quede completamente pulcra.

Evite obstrucciones en el sillón y en los instrumentos.  
¡Sorprendentes resultados!



	Descripción	Observaciones
	Bomba para BR + 1 botella limpiador BR 1.000ml <b>Ref.: 98-030501</b> (Ref. Metasys®: 108000034 / 40050501)	<b>498´00€</b>
	2 botellas limpiador BR <b>Ref.: 98-030300</b> (Ref. Metasys®: 122000002 / 60040300)	<b>89´80€</b> <b>Pack:</b> 2 unidades <b>Contenido:</b> 1 litro/ud

## MANTENIMIENTO ASPIRACIONES

### Mantenimiento aspiraciones



	Descripción	Observaciones
	Limpiador especial de sistemas aspiración DÜRR® MD-555 - Concentrado sin espuma para instalaciones dentales de aspiración y desagüe. - Complemento idóneo para Orotol Plus para el cuidado completo y perfecta limpieza y mantenimiento de instalaciones de aspiración de todo tipo. <b>Ref.: 68-37003</b>	1 unidad <b>Contenido:</b> 2,5 litros <b>67´80€</b>
	Filtro sólidos aspiraciones Cattani® <b>***Original Cattani***</b> <b>Ref.: 38-1055</b> (Ref. Cattani®: 1041055   Ref. Fedesa®: F034A91)	<b>Pack:</b> 1 unidad Utilizado en la mayoría de los sillones Fedesa® entre otros. <b>15´20€</b>
	Porta filtros rectangular gris 2 terminales <b>***Original Cattani***</b> <b>Ref.: 38-0854</b> (Ref. Cattani®: 200854)	(Ref. Fedesa®: 2403A03 + 034A91 + 710A12 + 2406A01) <b>48´00€</b>
	Filtro amarillo aspiraciones Dürr® <b>***Original Dürr***</b> <b>Ref.: 68-37001</b> (Ref. Dürr®: 0725.041.00)	<b>Pack:</b> 12 unidades Utilizado en algunos de los sillones Fedesa® entre otros. <b>40´80€</b>
	Cuerpo filtro amarillo doble entrada Dürr Connect <b>***Original Dürr***</b> <b>Ref.: 68-37004</b> (Ref. Dürr®: 0725.041.05)	**Adaptadores a manguera de 11mm y 17mm. <b>Consultar Refs.: 38-5037 y 38-5038</b> <b>23´80€</b>
	Filtro amarillo dos entradas Dürr Connect <b>***Original Dürr***</b> <b>Ref.: 68-37005</b> (Ref. Dürr®: 0700.705.54)	**Adaptadores a manguera de 11mm y 17mm. <b>Consultar Refs.: 38-5037 y 38-5038</b> <b>113´80€</b>

## VÁLVULAS DÜRR®

### Válvulas Dürr®









	Descripción	Observaciones
	Válvula antiretorno CAS-1, CSI y compatibles <b>Ref.: 68-26001</b> (Ref. Dürr®: 7117.420.43 - 1ud. de 2)	1 unidad <b>53<sup>80</sup>€</b>
	Válvula centralizadora / selectora aspiración <b>Ref.: 68-36001</b> (Ref. Dürr®: 7560.500.60E)	<b>183<sup>80</sup>€</b>
	Membrana válvula centralizadora / selectora aspiración <b>Ref.: 68-36002</b> (Ref. Dürr®: 7560.500.22)	<b>20<sup>80</sup>€</b>
	Válvula antiretorno Dürr Connect <b>Ref.: 68-36005</b> (Ref. Dürr®: 7128.100.03)	<b>21<sup>20</sup>€</b>

## REPUESTOS ASPIRACIONES DÜRR®

### Repuestos aspiraciones Dürr®



	Descripción	Observaciones
	Centrifugadora Dürr® CSI Comby Sepamatic (sin accesorios) <b>Ref.: 68-28020</b>	<b>748<sup>00</sup>€</b>
	Aspa / Turbina V300S y VS300S <b>Ref.: 68-25001</b> (Ref. Dürr®: 7119.983.054   Antigua 7119.933.55)	<b>249<sup>80</sup>€</b>
	Aspa / Turbina V600 y VS600 <b>Ref.: 68-25002</b> (Ref. Dürr®: 7127.983.55)	<b>323<sup>80</sup>€</b>
	Aspa / Turbina VSA300S <b>Ref.: 68-25005</b> (Ref. Dürr®: R7110.115.00E)	<b>93<sup>80</sup>€</b>
	Junta tórica desagüe VS-300 <b>Ref.: 68-25006</b> (Ref. Dürr®: R9000.402.23)	<b>10<sup>80</sup>€</b>
	Unión desagüe VS-300, VS-600, VS-900 y compatibles <b>Ref.: 68-25007</b> (Ref. Dürr®: 7128.100.02)	<b>15<sup>80</sup>€</b>





NUEVO

	Descripción	Observaciones
	Tapa + ventilador V300S, VS300S, V600, VS600, V900S y VS900S <b>Ref.: 68-25003</b> (Ref. Dürr®: 7130.982.54) <b>108<sup>80</sup>€</b>	
<b>NUEVO</b> 	Sensor amalgama VSA300S y otros. <b>Ref.: 68-25008</b> (Ref. Dürr®: R7125.983.00) <b>63<sup>80</sup>€</b>	
	Biofiltro HEPA H13 V300, VS300 y VSA 300S <b>Ref.: 68-25004</b> (Ref. Dürr®: R7119100010) <b>147<sup>80</sup>€</b>	
	Kit mantenimiento CS-1 <b>Ref.: 68-26003</b> (Ref. Dürr®: 7117.980.33) <b>129<sup>80</sup>€</b>	
	Contenedor amalgama Dürr® CAI, CASI y compatibles <b>Ref.: 68-26004</b> (Ref. Dürr®: 7117.033.00) <b>114<sup>80</sup>€</b>	

## CONECTORES DÜRR® CONNECT

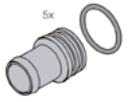
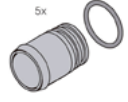
### DÜRR® Connect K (20mm)



	Descripción	Observaciones
	Dürr® Connect hembra a 15mm (K) <b>Ref.: 68-87004</b> (Ref. Dürr®: 0700.720.15E) <b>19<sup>80</sup>€</b>	<b>Pack:</b> 5 unidades
	Dürr® Connect macho a 20mm (K) <b>Ref.: 68-87003</b> (Ref. Dürr®: 0700.710.20E) <b>19<sup>80</sup>€</b>	<b>Pack:</b> 5 unidades
	Dürr® Connect macho a 25mm (K) <b>Ref.: 68-87020</b> (Ref. Dürr®: 0700.710.25E) <b>19<sup>80</sup>€</b>	<b>Pack:</b> 5 unidades
	Dürr® Connect "T" 2 x macho / 1 x hembra, c/sifón (K) <b>Ref.: 68-87021</b> (Ref. Dürr®: 0700.700.08E) <b>35<sup>80</sup>€</b>	<b>Pack:</b> 3 unidades
	Dürr® Connect macho-macho (K) <b>Ref.: 68-87014</b> (Ref. Dürr®: 0700.700.13E) <b>19<sup>80</sup>€</b>	<b>Pack:</b> 5 unidades
	Dürr® Connect hembra a 17mm (K) <b>Ref.: 68-87005</b> (Ref. Dürr®: 0700.720.17E) <b>19<sup>80</sup>€</b>	<b>Pack:</b> 5 unidades
	Dürr® Connect hembra a 18mm (K) <b>Ref.: 68-87007</b> (Ref. Dürr®: 0700.720.18E) <b>19<sup>80</sup>€</b>	<b>Pack:</b> 5 unidades

	Descripción	Observaciones
	Dürr® Connect hembra a 20mm (K) <b>Ref.: 68-87017</b> (Ref. Dürr®: 0700.720.20E) <b>19'80€</b>	Pack: 5 unidades
	Dürr® Connect hembra a 22mm (K) <b>Ref.: 68-87019</b> (Ref. Dürr®: 0700.720.22E) <b>19'80€</b>	Pack: 5 unidades
	Dürr® Connect hembra a 25mm (K) <b>Ref.: 68-87006</b> (Ref. Dürr®: 0700.720.25E) <b>19'80€</b>	Pack: 5 unidades
	Dürr® Connect hembra a 30mm (K) <b>Ref.: 68-87009</b> (Ref. Dürr®: 0700.720.30E) <b>19'80€</b>	Pack: 3 unidades
	Dürr® Connect hembra 36mm (K) <b>Ref.: 68-87008</b> (Ref. Dürr®: 0700.700.21E) <b>19'80€</b>	Pack: 5 unidades
	Dürr® Connect hembra-hembra (K) <b>Ref.: 68-87013</b> (Ref. Dürr®: 0700.700.11E) <b>19'80€</b>	Pack: 5 unidades
	Dürr® Connect manguito a 32mm (K) <b>Ref.: 68-87018</b> (Ref. Dürr®: 0700.700.20E) <b>19'80€</b>	Pack: 5 unidades
	Dürr® Connect codo 90° (K) <b>Ref.: 68-87015</b> (Ref. Dürr®: 0700.700.04E) <b>19'80€</b>	Pack: 5 unidades
	Dürr® Connect tapón sencillo (K) <b>Ref.: 68-87010</b> (Ref. Dürr®: 0700.700.10E) <b>19'80€</b>	Pack: 5 unidades
	Dürr® Connect "T" 1 x macho / 2 x hembra (K) <b>Ref.: 68-87012</b> (Ref. Dürr®: 0700.700.06E) <b>35'80€</b>	Pack: 3 unidades
	Dürr® Connect "T", 3 x macho (K) <b>Ref.: 68-87002</b> (Ref. Dürr®: 0700.700.02E) <b>19'80€</b>	Pack: 5 unidades
	Dürr® Connect "Y", 3 x macho (K) <b>Ref.: 68-87001</b> (Ref. Dürr®: 0700.700.03E) <b>19'80€</b>	Pack: 5 unidades
	Dürr® Connect clip pequeño (K) <b>Ref.: 68-87011</b> (Ref. Dürr®: 0700.700.01E) <b>19'80€</b>	Pack: 20 unidades
	Dürr® Connect anillo tórico (K) <b>Ref.: 68-87016</b> (Ref. Dürr®: 9000.402.54) <b>3'40€</b>	1 unidad

## DÜRR® Connect G (32mm)



	Descripción	Observaciones
	Dürr® Connect clip grande (G) <b>Ref.: 68-88004</b> (Ref. Dürr®: 0700.800.01E)	<b>Pack:</b> 20 unidades <b>35'80€</b>
	Dürr® Connect codo 90° (G) <b>Ref.: 68-88005</b> (Ref. Dürr®: 0700.800.04E)	<b>Pack:</b> 3 unidades <b>50'80€</b>
	Dürr® Connect hembra a 30mm (G) <b>Ref.: 68-88003</b> (Ref. Dürr®: 0700.820.30E)	<b>Pack:</b> 3 unidades <b>33'80€</b>
	Dürr® Connect macho a 30mm (G) <b>Ref.: 68-88001</b> (Ref. Dürr®: 0700.810.30E)	<b>Pack:</b> 3 unidades <b>33'80€</b>
	Dürr® Connect macho-macho (G) <b>Ref.: 68-88002</b> (Ref. Dürr®: 0700.800.13E)	<b>Pack:</b> 3 unidades <b>27'80€</b>

## MANGUERAS ASPIRACIÓN Y ACCESORIOS

- ▶ Mangueras aspiración **con terminales**
- ▶ Mangueras aspiración **sin terminales**
- ▶ Montaje terminales aspiración
- ▶ Terminales aspiración
- ▶ Adaptadores mangueras
- ▶ Conectores mangueras
- ▶ Adaptadores cánulas
- ▶ Cánulas

### Mangueras aspiración **con terminales**

#### Mangueras aspiración PVC PREMIUM con terminales





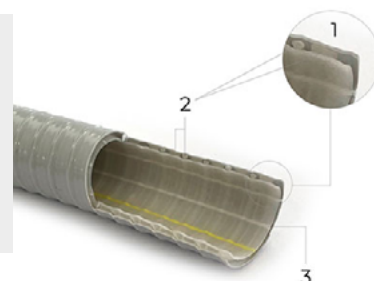

RUMAR

- **Calidad Premium**
- Máxima ligereza, flexibilidad y durabilidad.
- Resistente a todos los desinfectantes homologados.
- Color gris claro RAL 7035.
- **Terminales PREMIUM esterilizables**

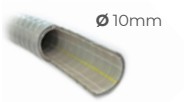
1. Doble capa de PVC flexible diseñada para una mayor durabilidad sin perder ligereza o flexibilidad.
2. Doble hélice de Polipropileno alrededor del eje para mayor durabilidad.
3. Hilos longitudinales para aumentar la integridad de la manguera.



#### Compatible con equipo Adec®

	Descripción	Observaciones
NUEVO	 <p>Manguera aspirasaliva PVC <b>PREMIUM</b> (fina) con terminal de aspiración completo  <b>Conector a equipo:</b> Adec® 200 y compatibles</p>  <p>Ref.: <b>36-810D160D</b> <span style="float: right;"><b>168´00,€</b></span></p>	<p><b>Longitud:</b> 160cm  <b>Ø interno:</b> 10mm</p> <p>Terminal esterilizable a 134°C.</p> <p style="text-align: right;"><b>BAJO PEDIDO</b></p>
NUEVO	 <p>Manguera aspirasaliva PVC <b>PREMIUM</b> (fina) con terminal de aspiración completo  <b>Conector a equipo:</b> Adec® 300, 500 y compatibles</p>  <p>Ref.: <b>36-810D160B</b> (Ref. Adec®: 11.1307.01 + terminal) <span style="float: right;"><b>114´80,€</b></span></p>	<p><b>Longitud:</b> 160cm  <b>Ø interno:</b> 10mm</p> <p>Terminal esterilizable a 134°C.</p> <p style="text-align: right;"><b>BAJO PEDIDO</b></p>
NUEVO	 <p>Manguera aspirasaliva PVC <b>PREMIUM</b> (fina) con terminal de aspiración completo  <b>Conector a equipo:</b> Adec® 300, 500 y compatibles</p>  <p>Ref.: <b>36-810D160C</b> <span style="float: right;"><b>168´00,€</b></span></p>	<p><b>Longitud:</b> 160cm  <b>Ø interno:</b> 10mm</p> <p>Terminal esterilizable a 134°C.</p> <p style="text-align: right;"><b>BAJO PEDIDO</b></p>

NUEVO

**Descripción**

Manguera aspiración quirúrgica PVC **PREMIUM** (gruesa) con terminal de aspiración completo  
**Conector a equipo:** Adec® 200 y compatibles

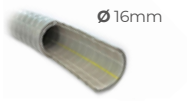

Ref.: **36-816D160A** (Ref. Adec®: 11.1340.00 + terminal)

**168<sup>00</sup>€**

**Observaciones**

**Longitud:** 160cm  
**Ø interno:** 16mm

Terminal esterilizable a 134°C.

BAJO PEDIDO

NUEVO

Manguera aspiración quirúrgica PVC **PREMIUM** (gruesa) con terminal de aspiración completo  
**Conector a equipo:** Adec® 300, 500 y compatibles



Ref.: **36-816D160B** (Ref. Adec®: 12.1238.01 + terminal)

**114<sup>80</sup>€**

**Longitud:** 160cm  
**Ø interno:** 16mm

Terminal esterilizable a 134°C.

BAJO PEDIDO

NUEVO

Manguera aspiración quirúrgica PVC **PREMIUM** (gruesa) con terminal de aspiración completo  
**Conector a equipo:** Adec® 300, 500 y compatibles



Ref.: **36-816D160C** (Ref. Adec®: 12.1239.01+ terminal)

**168<sup>00</sup>€**

**Longitud:** 160cm  
**Ø interno:** 16mm

Terminal esterilizable a 134°C.

BAJO PEDIDO

**Compatible con equipo Cattani®**

NUEVO

**Descripción**

Manguera aspirasaliva PVC **PREMIUM** (fina) con terminal de aspiración completo\*  
**Conector a equipo:** Abierta / open end



Ref.: **36-811B160B**

**46<sup>80</sup>€**

**Observaciones**

**Longitud:** 160cm  
**Ø interno:** 11mm  
 \*Ref. Terminal completo: 38-5025

Terminal esterilizable a 134°C.

NUEVO

Manguera aspiración quirúrgica PVC **PREMIUM** (gruesa) con terminal de aspiración completo\*  
**Conector a equipo:** Abierta / open end



Ref.: **36-817B160B**

**49<sup>80</sup>€**

**Longitud:** 160cm  
**Ø interno:** 17mm  
 \*Ref. Terminal completo: 38-5026

Terminal esterilizable a 134°C.

Compatible con equipo Cefla®

NUEVO

Descripción

Manguera aspirasaliva PVC **PREMIUM** (fina) con terminal de aspiración completo\*  
**Conector a equipo:** Abierta / open end

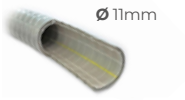

Ø 11mm



Ref.: **36-811B160A**

**58**´80.€

Observaciones

**Longitud:** 160cm  
**Ø interno:** 11mm  
 \*Ref. Terminal completo: 38-5022  
 Terminal esterilizable a 134°C.

NUEVO

Manguera aspiración quirúrgica PVC **PREMIUM** (gruesa) con terminal de aspiración completo\*  
**Conector a equipo:** Abierta / open end



Ø 17mm



Ref.: **36-817B160A**

**59**´80.€

**Longitud:** 160cm  
**Ø interno:** 17mm  
 \*Ref. Terminal completo: 38-5021  
 Terminal esterilizable a 134°C.

Compatible con equipo Durr®

NUEVO

Descripción

Manguera aspirasaliva PVC **PREMIUM** (fina) con terminal de aspiración completo  
**Conector a equipo:** Durr®

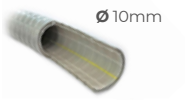

Ø 10mm



Ref.: **36-810D160A** (Ref. Durr®: 7600A020-50 + terminal)

**114**´80.€

Observaciones

**Longitud:** 160cm  
**Ø interno:** 10mm  
 Terminal esterilizable a 134°C.

BAJO PEDIDO

NUEVO

Manguera aspirasaliva PVC **PREMIUM** (fina) con terminal de aspiración completo  
**Conector a equipo:** Durr®

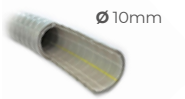

Ø 10mm



Ref.: **36-810D145A** (Ref. Durr®: 7600A010-51 + terminal)

**112**´80.€

**Longitud:** 145cm  
**Ø interno:** 10mm  
 Terminal esterilizable a 134°C.

BAJO PEDIDO

NUEVO

Manguera aspiración quirúrgica PVC **PREMIUM** (gruesa) con terminal de aspiración completo  
**Conector a equipo:** Durr®

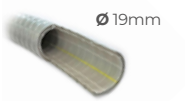

Ø 19mm



Ref.: **36-819D160A** (Ref. Durr®: 7600A010-50 + terminal)

**114**´80.€

**Longitud:** 160cm  
**Ø interno:** 19mm  
 Terminal esterilizable a 134°C.

BAJO PEDIDO

NUEVO



**Descripción**

Manguera aspiración quirúrgica PVC **PREMIUM** (gruesa) con terminal de aspiración completo  
**Conector a equipo:** Durr®



Ref.: **36-819D145A** (Ref. Durr®: 7600A020-51 + terminal)

**112<sup>80</sup>€**

**Observaciones**

**Longitud:** 145cm  
**Ø interno:** 19mm

Terminal esterilizable a 134°C.

BAJO PEDIDO

**Compatible con equipo KaVo®**

NUEVO



**Descripción**

Manguera aspirasaliva PVC **PREMIUM** (fina) con terminal de aspiración completo\*  
**Conector a equipo:** Abierta / open end



Ref.: **36-808B160A**

**54<sup>80</sup>€**

**Observaciones**

**Longitud:** 160cm  
**Ø interno:** 8mm  
 \*Ref. Terminal completo: 38-5027

Terminal esterilizable a 134°C.

NUEVO

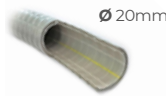

Manguera aspiración quirúrgica PVC **PREMIUM** (gruesa) con terminal de aspiración completo\*  
**Conector a equipo:** Abierta / open end



Ref.: **36-820B160A**

**69<sup>80</sup>€**

**Longitud:** 160cm  
**Ø interno:** 20mm  
 \*Ref. Terminal completo: 38-5028

Terminal esterilizable a 134°C.

NUEVO



Manguera aspirasaliva PVC **PREMIUM** (fina) con terminal de aspiración completo  
**Conector a equipo:** Kavo® 1058 Life, E50, E70 y compatibles



Ref.: **36-808D160A** (Ref. KaVo®: 3.004.7171)

**118<sup>00</sup>€**

**Longitud:** 160cm  
**Ø interno:** 8mm

Terminal esterilizable a 134°C.

BAJO PEDIDO

NUEVO

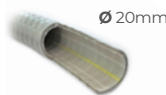

Manguera aspiración quirúrgica PVC **PREMIUM** (gruesa) con terminal de aspiración completo  
**Conector a equipo:** Kavo® 1058 Life, E50, E70 y compatibles



Ref.: **36-820D160A** (Ref. KaVo®: 3.004.7180)

**118<sup>00</sup>€**

**Longitud:** 160cm  
**Ø interno:** 20mm

Terminal esterilizable a 134°C.

BAJO PEDIDO

Compatible con equipo Planmeca®

NUEVO

Descripción

Manguera aspirasaliva PVC PREMIUM (fina) con terminal de aspiración completo\*  
**Conector a equipo:** Abierta / open end

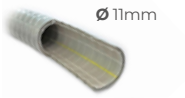

Ø 11mm



Ref.: **36-811B160C**

**61'80,€**

Observaciones

**Longitud:** 160cm  
**Ø interno:** 11mm  
 \*Ref. Terminal completo: 38-5031  
 Terminal esterilizable a 134°C.

NUEVO

Manguera aspiración quirúrgica PVC PREMIUM (gruesa) con terminal de aspiración completo\*  
**Conector a equipo:** Abierta / open end



Ø 17mm



Ref.: **36-817B160C**

**62'80,€**

**Longitud:** 160cm  
**Ø interno:** 17mm  
 \*Ref. Terminal completo: 38-5032  
 Terminal esterilizable a 134°C.

Compatible con equipo Sirona®

NUEVO

Descripción

Manguera aspirasaliva PVC PREMIUM (fina) con terminal de aspiración completo\*  
**Conector a equipo:** Abierta / open end

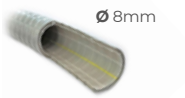

Ø 8mm



Ref.: **36-808B160B**

**54'80,€**

Observaciones

**Longitud:** 160cm  
**Ø interno:** 8mm  
 \*Ref. Terminal completo: 38-5029  
 Terminal esterilizable a 134°C.

NUEVO

Manguera aspiración quirúrgica PVC PREMIUM (fina) con terminal de aspiración completo\*  
**Conector a equipo:** Abierta / open end

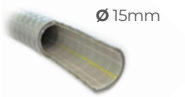

Ø 15mm



Ref.: **36-815B160A**

**54'80,€**

**Longitud:** 160cm  
**Ø interno:** 15mm  
 \*Ref. Terminal completo: 38-5030  
 Terminal esterilizable a 134°C.

NUEVO

Manguera aspirasaliva PVC PREMIUM (fina) con terminal de aspiración completo  
**Conector a equipo:** Sirona® C1, C1+, C2, C2+, C3, C3+, C4, C4+, C5, C5+, M1+, Teneo, Sinius y compatibles

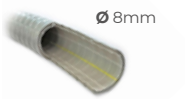

Ø 8mm



Ref.: **36-808D140A** (Ref. Sirona®: 1894836)

**118'00,€**

**Longitud:** 140cm  
**Ø interno:** 15mm  
 Terminal esterilizable a 134°C.

BAJO PEDIDO

NUEVO

NUEVO

NUEVO

**Descripción**

Manguera aspirasaliva PVC **PREMIUM** (fina) con terminal de aspiración completo  
**Conector a equipo:** Sirona® C8+, ProFeel+, INTEGO y compatibles



Ref.: **36-808D140B** (Ref. Sirona®: 6458967)

**114<sup>80</sup>€**

**Observaciones**

**Longitud:** 140cm  
**Ø interno:** 8mm

Terminal esterilizable a 134°C.

BAJO PEDIDO

Manguera aspiración quirúrgica PVC **PREMIUM** (gruesa) con terminal de aspiración completo

**Conector a equipo:** Sirona® C1, C1+, C2, C2+, C3, C3+, C4, C4+, C5, C5+, M1+, Teneo, Sinius y compatibles



Ref.: **36-815C140A** (Ref. Sirona®: 1894810)

**114<sup>80</sup>€**

**Longitud:** 140cm  
**Ø interno:** 15mm

BAJO PEDIDO

Manguera aspiración quirúrgica PVC **PREMIUM** (gruesa) con terminal de aspiración completo

**Conector a equipo:** Sirona® C8+, ProFeel+, INTEGO y compatibles



Ref.: **36-815D140A** (Ref. Sirona®: 6458959)

**114<sup>80</sup>€**

**Longitud:** 140cm  
**Ø interno:** 15mm

Terminal esterilizable a 134°C.

BAJO PEDIDO

Mangueras aspiración PVC flexible ECO con terminales

RUMAR

- Doble pared reforzada de PVC flexible.
- Buena flexibilidad.
- Terminal no esterilizable

- Resistente a todos los desinfectantes homologados.
- Color gris claro RAL 7035.



**Descripción**

Manguera aspiración PVC ECO **con terminal.**  
**Conector a equipo:** Abierta / open end



Ref.: **36-011B160A**

**28<sup>00</sup>€**

**Observaciones**

**Longitud:** 160cm  
**Ø interno:** 11mm

Terminal **NO** esterilizable

(Antigua 36-111)

Manguera aspiración PVC ECO **con terminal.**

**Conector a equipo:** Abierta / open end



Ref.: **36-017B160A**

**28<sup>80</sup>€**

**Longitud:** 160cm  
**Ø interno:** 17mm

Terminal **NO** esterilizable

(Antigua 36-117)

# Mangueras aspiración sin terminales

## Mangueras aspiración PVC PREMIUM sin terminales

RUMAR

- **Calidad Premium**
- Máxima ligereza, flexibilidad y durabilidad.
- Resistente a todos los desinfectantes homologados.
- Color gris claro RAL 7035.

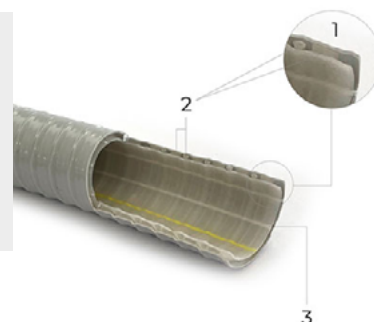

1. Doble capa de PVC flexible diseñada para una mayor durabilidad sin perder ligereza o flexibilidad.
2. Doble hélice de Polipropileno alrededor del eje para mayor durabilidad.
3. Hilos longitudinales para aumentar la integridad de la manguera.



### Descripción

### Observaciones

 <p>Ø 8mm</p>	<p>Manguera aspiración PVC <b>PREMIUM</b> Ø interno: 8mm</p> <p>Ref.: <b>36-808M*</b> Al corte( &lt; 10 metros) <b>26'80€</b></p> <p>Ref.: <b>36-808M*</b> Al corte( ≥ 10 metros) <b>24'80€</b></p> <p>Ref.: <b>36-808R</b> Rollo 25 metros <b>568'00€</b></p>	<p>*<b>FORMATO AL CORTE:</b> metros enteros, no fracción. <b>No admiten devolución.</b></p> <p><b>Compatibilidad:</b> Euroden®, KaVo®, Ritter®, Sirona®.</p>
<p><b>NUEVO</b></p>  <p>Ø 10mm</p>	<p>Manguera aspiración PVC <b>PREMIUM</b> Ø interno: 10mm</p> <p>Ref.: <b>36-810M*</b> Al corte( &lt; 10 metros) <b>26'80€</b></p> <p>Ref.: <b>36-810M*</b> Al corte( ≥ 10 metros) <b>24'80€</b></p> <p>Ref.: <b>36-810R</b> Rollo 25 metros <b>568'00€</b></p>	<p>*<b>FORMATO AL CORTE:</b> metros enteros, no fracción. <b>No admiten devolución.</b></p> <p><b>Compatibilidad:</b> Adec® y otros.</p>
 <p>Ø 11mm</p>	<p>Manguera aspiración PVC <b>PREMIUM</b> Ø interno: 11mm</p> <p>Ref.: <b>36-811M*</b> Al corte( &lt; 10 metros) <b>21'80€</b></p> <p>Ref.: <b>36-811M*</b> Al corte( ≥ 10 metros) <b>19'80€</b></p> <p>Ref.: <b>36-811R</b> Rollo 25 metros <b>448'00€</b></p>	<p>*<b>FORMATO AL CORTE:</b> metros enteros, no fracción. <b>No admiten devolución.</b></p> <p><b>Compatibilidad:</b> Ancar®, Cattani®, Cefla® (Anthos, Castellini y Stern Weber), Chirana®, Euron®, Fedesa®, Fimet®, Galit®, Migliónico®, Planmeca®, Ultradent® y otros.</p>
 <p>Ø 15mm</p>	<p>Manguera aspiración PVC <b>PREMIUM</b> Ø interno: 15mm</p> <p>Ref.: <b>36-815M*</b> Al corte( &lt; 10 metros) <b>28'00€</b></p> <p>Ref.: <b>36-815M*</b> Al corte( ≥ 10 metros) <b>25'80€</b></p> <p>Ref.: <b>36-815R</b> Rollo 25 metros <b>568'00€</b></p>	<p>*<b>FORMATO AL CORTE:</b> metros enteros, no fracción. <b>No admiten devolución.</b></p> <p><b>Compatibilidad:</b> Euroden®, Sirona® y otros.</p>
<p><b>NUEVO</b></p>  <p>Ø 16mm</p>	<p>Manguera aspiración PVC <b>PREMIUM</b> Ø interno: 16mm</p> <p>Ref.: <b>36-816M*</b> Al corte( &lt; 10 metros) <b>30'80€</b></p> <p>Ref.: <b>36-816M*</b> Al corte( ≥ 10 metros) <b>27'80€</b></p> <p>Ref.: <b>36-816R</b> Rollo 25 metros <b>628'00€</b></p>	<p>*<b>FORMATO AL CORTE:</b> metros enteros, no fracción. <b>No admiten devolución.</b></p> <p><b>Compatibilidad:</b> Adec® y otros.</p>





	Descripción	Observaciones
	<p>Manguera aspiración PVC <b>PREMIUM</b>                      Ø interno: 17mm</p> <p>Ref.: <b>36-817M*</b> Al corte( &lt; 10 metros) <b>22´80€</b></p> <p>Ref.: <b>36-817M*</b> Al corte( ≥ 10 metros) <b>21´80€</b></p> <p>Ref.: <b>36-817R</b> Rollo 25 metros <b>498´00€</b></p>	<p><b>*FORMATO AL CORTE:</b> metros enteros, no fracción. <b>No admiten devolución.</b></p> <p><b>Compatibilidad:</b> Ancar®, Cattani®, Cefla® (Anthos, Castellini y Stern Weber), Chirana®, Euron®, Fedesa®, Fimet®, Galit®, Miglionico®, Planmecca®, Ultradent® y otros.</p>
	<p>Manguera aspiración PVC <b>PREMIUM</b>                      Ø interno: 20mm</p> <p>Ref.: <b>36-820M*</b> Al corte( &lt; 10 metros) <b>33´80€</b></p> <p>Ref.: <b>36-820M*</b> Al corte( ≥ 10 metros) <b>30´80€</b></p> <p>Ref.: <b>36-820R</b> Rollo 25 metros <b>698´00€</b></p>	<p><b>*FORMATO AL CORTE:</b> metros enteros, no fracción. <b>No admiten devolución.</b></p> <p><b>Compatibilidad:</b> KaVo®, Ritter® y otros.</p>

**Mangueras aspiración PVC ECO flexible sin terminales** **RUMAR**

- Doble pared reforzada de PVC flexible.
- Buena flexibilidad.

- Resistente a todos los desinfectantes homologados.
- Color gris claro RAL 7035.



	Descripción	Observaciones
	<p>Manguera aspiración PVC <b>ECO</b>.                      Ø interno: 8mm</p> <p>Ref.: <b>36-008A160</b> 160 cm <b>18´80€</b></p>	<p><b>Compatibilidad:</b> Euroden®, KaVo®, Ritter®, Sirona®.</p> <p>(Antigua 36-008)</p>
	<p>Manguera aspiración PVC <b>ECO</b>.                      Ø interno: 11mm</p> <p>Ref.: <b>36-011A160</b> 160 cm <b>18´80€</b></p> <p>Ref.: <b>36-011M*</b> Al corte <b>15´80€</b></p> <p>Ref.: <b>36-011R</b> Rollo 12 metros <b>132´80€</b></p>	<p><b>*FORMATO AL CORTE:</b> metros enteros, no fracción. <b>No admiten devolución.</b></p> <p><b>Compatibilidad:</b> Ancar®, Cattani®, Cefla® (Anthos, Castellini y Stern Weber), Chirana®, Euron®, Fedesa®, Fimet®, Galit®, Miglionico®, Planmecca®, Ultradent® y otros.</p> <p>(Antigua 36-011)</p>
	<p>Manguera aspiración PVC <b>ECO</b>.                      Ø interno: 15mm</p> <p>Ref.: <b>36-015A160</b> 160 cm <b>18´80€</b></p>	<p><b>Compatibilidad:</b> Euroden®, Sirona® y otros.</p> <p>(Antigua 36-015)</p>
	<p>Manguera aspiración PVC <b>ECO</b>.                      Ø interno: 17mm</p> <p>Ref.: <b>36-017A160</b> 160 cm <b>19´80€</b></p> <p>Ref.: <b>36-017M*</b> Al corte <b>16´80€</b></p> <p>Ref.: <b>36-017R</b> Rollo 12 metros <b>142´80€</b></p>	<p><b>*FORMATO AL CORTE:</b> metros enteros, no fracción. <b>No admiten devolución.</b></p> <p><b>Compatibilidad:</b> Ancar®, Cattani®, Cefla® (Anthos, Castellini y Stern Weber), Chirana®, Euron®, Fedesa®, Fimet®, Galit®, Miglionico®, Planmecca®, Ultradent® y otros.</p> <p>(Antigua 36-017)</p>
	<p>Manguera aspiración PVC <b>ECO</b>.                      Ø interno: 20mm</p> <p>Ref.: <b>36-020A160</b> 160 cm <b>22´80€</b></p>	<p><b>Compatibilidad:</b> KaVo®, Ritter® y otros.</p> <p>(Antigua 36-020)</p>

Mangueras aspiración EVA extraflexible sin terminales

- Máxima calidad y durabilidad.
- Manguera extra flexible de Etyl-Vinilo-Acetato.
- Corrugada interior y exterior.
- Resistente a todos los desinfectantes homologados.
- Color: gris claro RAL 7035.
- **Diseño especial equipos CEFLA (Stern Weber®, Castellini® y Anthos®).**



	Descripción	Observaciones
	Manguera aspiración EVA extraflexible. <b>Ø interno: 11mm</b>  Ref.: <b>36-611M*</b> Al corte <span style="float: right;"><b>8'80€</b></span> Ref.: <b>36-611R</b> Rollo 25 metros <span style="float: right;"><b>159'80€</b></span>	* <b>FORMATO AL CORTE:</b> metros enteros, no fracción. <b>No admiten devolución.</b> <b>Incluye:</b> adaptadores silicona  <b>Compatibilidad:</b> Cefla® (Anthos, Castellini y Stern Weber) y otros.
	Manguera aspiración EVA extraflexible. <b>Ø interno: 17mm</b>  Ref.: <b>36-617M*</b> Al corte <span style="float: right;"><b>9'40€</b></span> Ref.: <b>36-617R</b> Rollo 25 metros <span style="float: right;"><b>188'00€</b></span>	* <b>FORMATO AL CORTE:</b> metros enteros, no fracción. <b>No admiten devolución.</b>  <b>Compatibilidad:</b> Cefla® (Anthos, Castellini y Stern Weber) y otros.

Montaje terminales aspiración y accesorios

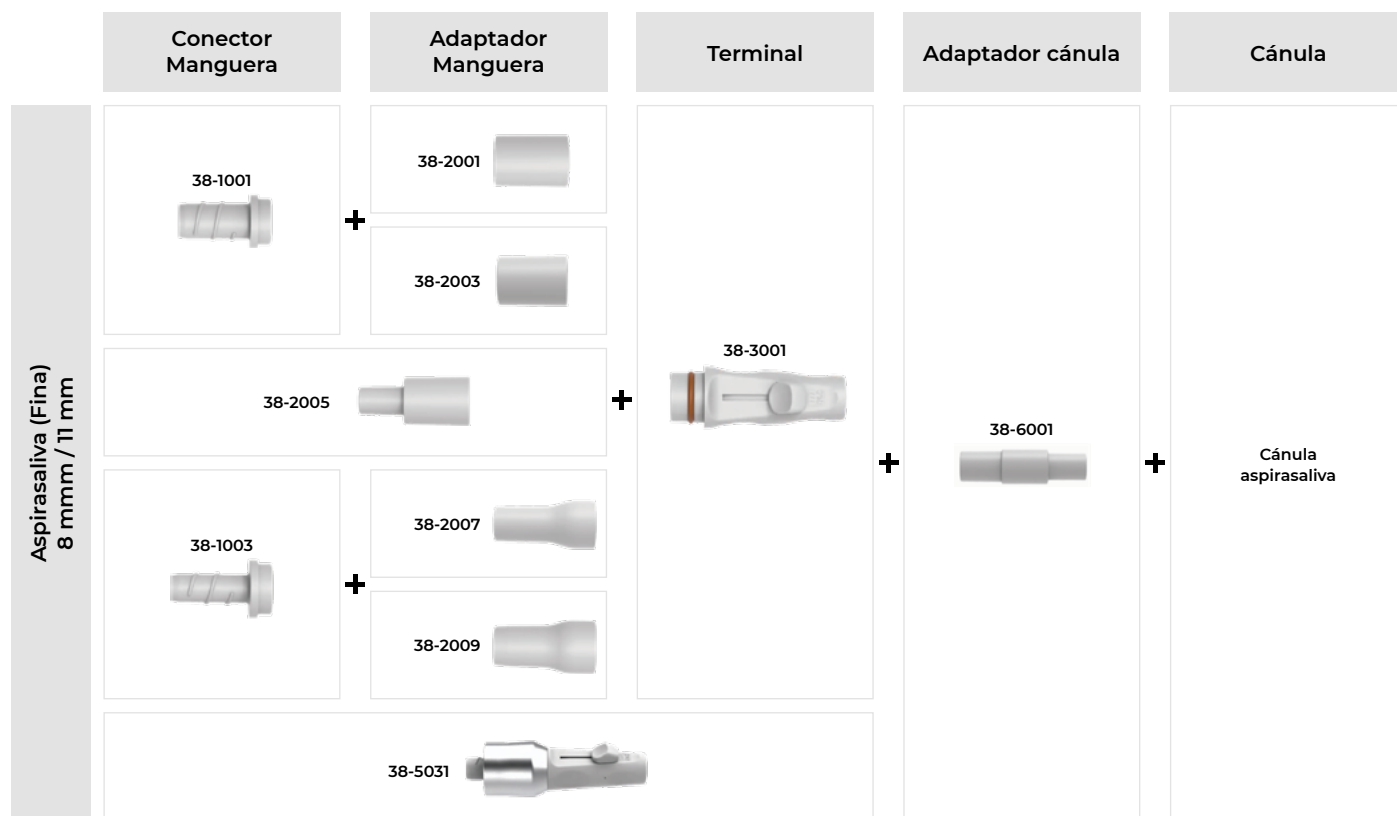

**Aspiración quirúrgica (Gruesa)**  
15 mm / 17 mmm / 20 mm

Conector Manguera	Adaptador Manguera	Terminal	Adaptador cánula	Cánula
38-1002	38-2002	38-3002	38-6002	Cánula aspiración quirúrgica
	38-2004			
38-2006				
38-1004	38-2008			
38-1005	38-2010			
38-5032				

**Aspirativa (Fina)**

d <sub>1</sub>	d <sub>2</sub>	Forma	Ref. Nr./No.
6,0	20,7		68-38008
7,2	21,0		68-38009
8,0	21,0		68-38010
10,0	21,0		68-38012
10,0	21,0		68-38013
10,0	21,0		68-38015

68-38027      68-38029

68-38028      68-38030

68-38031

68-38034

**Aspiración quirúrgica (Gruesa)**

d <sub>1</sub>	d <sub>2</sub>	Forma	Ref. Nr./No.
10,0	26,3		68-38001
17,0	26,3		68-38002
20,0	26,3		68-38003
19,0	26,3		68-38004
18,0	26,3		68-38006
18,0	26,3		68-38007

68-38016

68-38017

68-38018

68-38019

68-38020

68-38021

68-38022

68-38023

68-38024

68-38025

68-38026

Ø 16 mm













Ø 11 mm

# Terminales aspiración

## Terminales de aspiración completo PREMIUM

RUMAR







- Resistente a todos los desinfectantes homologados.
- **Esterilizable**











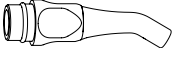

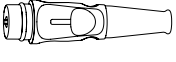
	Descripción	Observaciones
NUEVO	 <p><b>Terminal aspiración completo</b> para mangueras de ø10mm, compatible Adec®</p> <p>Ref.: <b>38-5033</b> (Ref. Adec®: 12.1258.00)</p>	18´00€
NUEVO	 <p><b>Terminal aspiración completo</b> para mangueras de ø16mm, compatible Adec®</p> <p>Ref.: <b>38-5034</b> (Ref. Adec®: 11.1335.00)</p>	18´00€
NUEVO	 <p><b>Terminal aspiración completo</b> para mangueras de ø11mm, compatible Cattani®</p> <p>Ref.: <b>38-5025</b> (Ref. Cattani®: 040631)</p>	18´00€
NUEVO	 <p><b>Terminal aspiración completo</b> para mangueras de ø17mm, compatible Cattani®</p> <p>Ref.: <b>38-5026</b> (Ref. Cattani®: 040641)</p>	18´00€
NUEVO	 <p><b>Terminal aspiración completo</b> para mangueras de ø11mm, compatible Cefla® (Anthos, Castellini y Stern Weber)</p> <p>Ref.: <b>38-5021</b> (Ref. Cefla®: 91109167)</p>	28´00€
NUEVO	 <p><b>Terminal aspiración completo</b> para mangueras de ø17mm, compatible Cefla® (Anthos, Castellini y Stern Weber)</p> <p>Ref.: <b>38-5022</b> (Ref. Cefla®: 91109166)</p>	28´00€
NUEVO	 <p><b>Terminal aspiración completo</b> para mangueras de ø11mm, compatible Cefla® (Anthos, Castellini y Stern Weber)</p> <p>Ref.: <b>38-5023</b> (Ref. Cefla®: 91109167)</p>	28´00€
NUEVO	 <p><b>Terminal aspiración completo</b> para mangueras de ø17mm, compatible Cefla® (Anthos, Castellini y Stern Weber)</p> <p>Ref.: <b>38-5024</b> (Ref. Cefla®: 91109166)</p>	28´00€
NUEVO	 <p><b>Terminal aspiración completo</b> para mangueras de ø10mm, compatible Durr® Comfort</p> <p>Ref.: <b>38-5035</b> (Ref. Durr®: 7600A020-11 + 7600A025-50)</p>	18´00€
NUEVO	 <p><b>Terminal aspiración completo</b> para mangueras de ø19mm, compatible Durr® Comfort</p> <p>Ref.: <b>38-5036</b> (Ref. Durr®: 7600A010-20 + 7600A010-00)</p>	18´00€
NUEVO	 <p><b>Terminal aspiración completo</b> para mangueras de ø8mm, compatible KaVo®</p> <p>Ref.: <b>38-5027</b> (Ref. KaVo®: 0.211.1751)</p>	18´00€
NUEVO	 <p><b>Terminal aspiración completo</b> para mangueras de ø20mm, compatible KaVo®</p> <p>Ref.: <b>38-5028</b> (Ref. KaVo®: 0.211.1761)</p>	28´00€

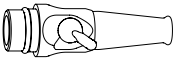
	Descripción	Observaciones
NUEVO	 <p><b>Terminal aspiración completo</b> para mangueras de ø11mm, compatible Planmeca®</p> <p>Ref.: <b>38-5031</b> (Ref. Planmeca®: 10039173)</p> <p><b>32'80€</b></p>	
NUEVO	 <p><b>Terminal aspiración completo</b> para mangueras de ø17mm, compatible Planmeca®</p> <p>Ref.: <b>38-5032</b> (Ref. Planmeca®: 10039172)</p> <p><b>32'80€</b></p>	
NUEVO	 <p><b>Terminal aspiración completo</b> para mangueras de ø8mm, compatible Sirona®</p> <p>Ref.: <b>38-5029</b> (Ref. Sirona®: 5957803 + 6459460)</p> <p><b>18'00€</b></p>	
NUEVO	 <p><b>Terminal aspiración completo</b> para mangueras de ø15mm, compatible Sirona®</p> <p>Ref.: <b>38-5030</b> (Ref. Sirona®: 5957795 + 6459452)</p> <p><b>18'00€</b></p>	

### Terminales de aspiración PREMIUM

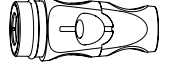



- Resistente a todos los desinfectantes homologados.  
**- Esterilizable**

	Descripción	Observaciones
NUEVO	 <p><b>Terminal aspirasaliva (Fina)</b></p> <p>Ref.: <b>38-3001</b></p> <p><b>15'80€</b></p>	
NUEVO	 <p><b>Terminal aspiración quirúrgica (Gruesa)</b></p> <p>Ref.: <b>38-3002</b></p> <p><b>15'80€</b></p>	
NUEVO	 <p><b>Adaptador aspiración</b> ø16mm a 11mm</p> <p>Ref.: <b>38-6002</b> (Ref. Cattani®: 1040520)</p> <p><b>2'00€</b></p>	
NUEVO	 <p><b>Lengüeta deslizante</b> terminal* aspirasaliva (Fina 38-3001)</p> <p>Ref.: <b>38-6003/10</b></p> <p><b>4'80€</b></p>	*Ref. Terminal: 38-3001 (Pack 10 Uds.)
NUEVO	 <p><b>Lengüeta deslizante</b> terminal aspiración quirúrgica (Gruesa 38-3002)</p> <p>Ref.: <b>38-6004/10</b></p> <p><b>4'80€</b></p>	*Ref. Terminal: 38-3002 (Pack 10 Uds.)
NUEVO	 <p><b>Lengüeta deslizante</b> terminal* aspirasaliva (Fina), compatible Cattani®</p> <p>Ref.: <b>38-6005/10</b> (Ref. Cattani®: 205368)</p> <p><b>4'80€</b></p>	(Pack 10 Uds.)
NUEVO	 <p><b>Lengüeta deslizante</b> terminal* aspiración quirúrgica (Gruesa), compatible Cattani®</p> <p>Ref.: <b>38-6006/10</b> (Ref. Cattani®: 205369)</p> <p><b>4'80€</b></p>	(Pack 10 Uds.)

	Descripción	Observaciones
 	Terminal angular, tubo fino, gris, con pestillo giratorio. Dürer Confort® y Sirona® <b>Ref.: 68-38027</b> (Ref. Dürer®: 7600A20-00 / Ref. Sirona®: 5957803)	<b>33<sup>80</sup>€</b>
<b>NUEVO</b>  	Terminal angular, tubo fino, gris, sin pestillo giratorio. <b>Ref.: 68-38031</b> (Ref. Dürer®: 7600A021-00)	<b>17<sup>10</sup>€</b>
 	Punta terminal angular, tubo fino, gris. Dürer Confort® y Sirona® <b>Ref.: 68-38027P</b> (Ref. Dürer®: 7600A020-03E)	<b>40<sup>80</sup>€</b> <b>Pack: 3 unidades</b>
 	Terminal recto, tubo fino, gris, con pestillo deslizamiento. <b>Ref.: 68-38028</b> (Ref. Dürer®: 7600A025-00)	<b>29<sup>80</sup>€</b>
 	Terminal recto, tubo fino, gris, con pestillo giratorio. <b>Ref.: 68-38029</b> (Ref. Dürer®: 7600A020-55)	<b>38<sup>80</sup>€</b>
 	Terminal recto, tubo fino, gris, con pestillo deslizamiento. Dürer Confort® <b>Ref.: 68-38030</b> (Ref. Dürer®: 7600A025-50)	<b>23<sup>20</sup>€</b>
 	Terminal angular, tubo grueso, gris, con pestillo desplazamiento. Dürer Confort® y Sirona® <b>Ref.: 68-38017</b> (Ref. Dürer®: 7600A010-00 / Ref. Sirona®: 5957795)	<b>34<sup>80</sup>€</b>
 	Terminal angular, tubo grueso, gris, sin pestillo desplazamiento. <b>Ref.: 68-38018</b> (Ref. Dürer®: 7600A040-00)	<b>19<sup>80</sup>€</b>
 	Terminal articulación gris terminal de aspiración grueso. Dürer Confort® y Sirona® <b>Ref.: 68-38016</b> (Ref. Dürer®: 7600A030-00 / Ref. Sirona®: 5957811)	<b>29<sup>80</sup>€</b>

## Terminales de aspiración completo ECO

- Resistente a todos los desinfectantes homologados.

	Descripción	Observaciones
	Terminal aspiración + adaptador-conector para mangueras de ø11 mm, compatible Fedesa® <b>Ref.: 38-5037</b> (Ref. Fedesa®: 034A37) <b>6'80€</b>	Montaje en manguera con pegamento <b>No esterilizable</b>
	Terminal aspiración + adaptador-conector para mangueras de ø17 mm, compatible Fedesa® <b>Ref.: 38-5038</b> (Ref. Fedesa®: 034A36) <b>6'80€</b>	Montaje en manguera con calor <b>No esterilizable</b>
	Terminal aspiración adaptador-conector para mangueras de ø6,35 - 7,00mm <b>Ref.: 38-007T</b> <b>13'80€</b>	<b>No esterilizable</b>
	Terminal aspiración adaptador-conector para mangueras de ø12,4 - 12,55mm <b>Ref.: 38-013T</b> <b>10'80€</b>	<b>No esterilizable</b>





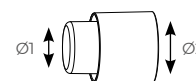

## Adaptador / Conector manguera aspiración PREMIUM

- Resistente a todos los desinfectantes homologados.

Ejemplo:



	Descripción	Observaciones
<b>NUEVO</b>  RUMAR	Adaptador manguera aspiración ø11mm, compatible Cattani® <b>Ref.: 38-2001</b> <b>1'00€</b>	
<b>NUEVO</b>  RUMAR	Adaptador manguera aspiración ø17mm, compatible Cattani® <b>Ref.: 38-2002</b> <b>1'00€</b>	
<b>NUEVO</b>  RUMAR	Adaptador manguera aspiración ø11mm, compatible Cefla® <b>Ref.: 38-2003</b> <b>13'80€</b>	<b>No mangueras EVA</b>
<b>NUEVO</b>  RUMAR	Adaptador manguera aspiración ø17mm, compatible Cefla® <b>Ref.: 38-2004</b> <b>14'80€</b>	<b>No mangueras EVA</b>
<b>NUEVO</b>  RUMAR	Adaptador + conector manguera aspiración ø11mm, compatible Cefla® <b>Ref.: 38-2005</b> <b>13'80€</b>	<b>Mangueras EVA</b>
<b>NUEVO</b>  RUMAR	Adaptador + conector manguera aspiración ø17mm, compatible Cefla® <b>Ref.: 38-2006</b> <b>14'80€</b>	<b>Mangueras EVA</b>

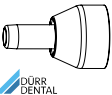



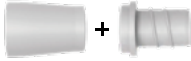
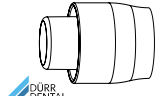
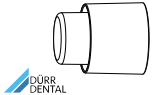
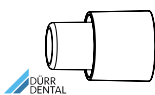
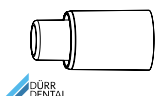
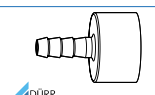
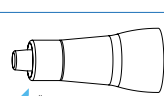
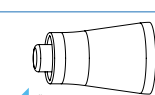
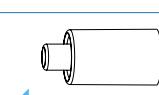
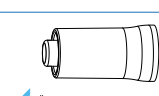
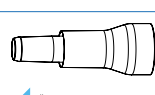

	Descripción	Observaciones
NUEVO	 RUMAR Ref.: <b>38-2007</b>	Adaptador manguera aspiración ø8mm, compatible KaVo® 1'00€
NUEVO	 RUMAR Ref.: <b>38-2008</b>	Adaptador manguera aspiración ø20mm, compatible KaVo® 13'80€
NUEVO	 RUMAR Ref.: <b>38-2009</b>	Adaptador manguera aspiración ø8mm, compatible Sirona® 1'00€
NUEVO	 RUMAR Ref.: <b>38-2010</b>	Adaptador manguera aspiración ø15mm, compatible Sirona® 1'00€
NUEVO	 RUMAR Ref.: <b>38-1001</b>	Conector manguera aspiración ø11mm, compatible Cattani® y Cefla® 1'00€
NUEVO	 RUMAR Ref.: <b>38-1002</b>	Conector manguera aspiración ø17mm, compatible Cattani® y Cefla® 1'00€
NUEVO	 RUMAR Ref.: <b>38-1003</b>	Conector manguera aspiración ø8mm, compatible KaVo® y Sirona® 1'00€
NUEVO	 RUMAR Ref.: <b>38-1004</b>	Conector manguera aspiración ø20mm, compatible KaVo® 1'00€
NUEVO	 RUMAR Ref.: <b>38-1005</b>	Conector manguera aspiración ø15mm, compatible Sirona® 1'00€
NUEVO	 RUMAR Ref.: <b>38-6007/5</b>	Herramienta montaje adaptador manguera gruesa PREMIUM Pack 5 uds. 4'00€
NUEVO	 RUMAR Ref.: <b>38-6008/5</b>	Herramienta montaje adaptador manguera fina PREMIUM Pack 5 uds. 1'00€
	 DÜRR DENTAL Ref.: <b>68-38001</b> (Ref. Dürr®: 7600A010-10)	Adaptador-conector para manguera-terminal ø10mm, universal Diámetro: Ø1: 10,0mm x Ø2: 26,3mm 17'80€
	 DÜRR DENTAL Ref.: <b>68-38002</b> (Ref. Dürr®: 7600A010-16)	Adaptador-conector para manguera-terminal ø17mm, Adec® Diámetro: Ø1: 17,0mm x Ø2: 26,3mm 18'80€
NUEVO	 RUMAR Ref.: <b>Kit 38-2010 + 38-1005</b> (Ref. Sirona®: 6319805)	Conector + Adaptador para manguera aspiración ø8mm, compatible Sirona® 1'00€

NUEVO





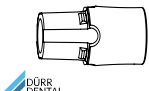
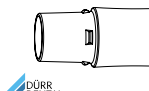
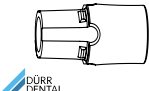

	Descripción	Observaciones
 <p>RUMAR</p>	<p>Conector + Adaptador para manguera aspiración ø15mm, compatible Sirona®</p> <p><b>Kit 38-2009 + 38-1003</b> (Ref. Sirona®: 6459460)</p>	
 <p>DÜRR DENTAL</p>	<p>Adaptador-conector manguera-terminal ø20mm, KaVo®</p> <p>Ref.: <b>68-38003</b> (Ref. Dürr®: 7600A010-19)</p> <p>18´80,€</p>	<p>Diámetro: Ø1: 20,0mm x Ø2: 26,3mm</p>
 <p>DÜRR DENTAL</p>	<p>Adaptador-conector manguera-terminal Dürr® Comfort.</p> <p>Ref.: <b>68-38004</b> (Ref. Dürr®: 7600A010-20)</p> <p>18´80,€</p>	<p>Diámetro: Ø1: 19,0mm x Ø2: 26,3mm</p>
 <p>DÜRR DENTAL</p>	<p>Adaptador-conector manguera-terminal ø18mm, universal</p> <p>Ref.: <b>68-38006</b> (Ref. Dürr®: 7600A010-23)</p> <p>18´80,€</p>	<p>Diámetro: Ø1: 18,0mm x Ø2: 26,3mm</p>
 <p>DÜRR DENTAL</p>	<p>Adaptador-conector manguera-terminal ø18mm, universal</p> <p>Ref.: <b>68-38007</b> (Ref. Dürr®: 7600A010-25)</p> <p>20´80,€</p>	<p>Diámetro: Ø1: 18,0mm x Ø2: 26,3mm</p>
 <p>DÜRR DENTAL</p>	<p>Adaptador-conector manguera-terminal ø6mm, universal</p> <p>Ref.: <b>68-38008</b> (Ref. Dürr®: 7600A020-06)</p> <p>21´80,€</p>	<p>Diámetro: Ø1: 6,0mm x Ø2: 20,7mm</p>
 <p>DÜRR DENTAL</p>	<p>Adaptador-conector para manguera-terminal A-dec 7,2mm.</p> <p>Ref.: <b>68-38009</b> (Ref. Dürr®: 7600A020-07)</p> <p>14´80,€</p>	<p>Diámetro: Ø1: 7,2mm x Ø2: 21,0mm</p>
 <p>DÜRR DENTAL</p>	<p>Adaptador-conector para manguera-terminal KaVo® 8mm.</p> <p>Ref.: <b>68-38010</b> (Ref. Dürr®: 7600A020-08)</p> <p>16´80,€</p>	<p>Diámetro: Ø1: 8,0mm x Ø2: 21,0mm</p>
 <p>DÜRR DENTAL</p>	<p>Adaptador-conector para manguera-terminal Cattani® 10mm.</p> <p>Ref.: <b>68-38012</b> (Ref. Dürr®: 7600A020-10)</p> <p>16´80,€</p>	<p>Diámetro: Ø1: 10,0mm x Ø2: 21,0mm</p>
 <p>DÜRR DENTAL</p>	<p>Adaptador-conector para manguera-terminal Dürr® Comfort.</p> <p>Ref.: <b>68-38013</b> (Ref. Dürr®: 7600A020-11)</p> <p>18´80,€</p>	<p>Diámetro: Ø1: 10,0mm x Ø2: 21,0mm</p>
 <p>DÜRR DENTAL</p>	<p>Adaptador-conector para manguera-terminal universal 10mm.</p> <p>Ref.: <b>68-38015</b> (Ref. Dürr®: 7600A020-13)</p> <p>16´80,€</p>	<p>Diámetro: Ø1: 10,0mm x Ø2: 21,0mm</p>

## Adaptador cánula aspiración

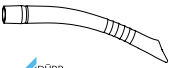
- Resistente a todos los desinfectantes homologados.
- **Esterilizable**

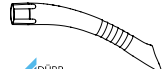
	Descripción	Observaciones
 RUMAR	Adaptador terminal cánula salvador. <b>Ø interno:</b> 11mm interior <b>Ref.: 38-511/5</b>	<b>Pack:</b> 5 unidades <b>18<sup>80</sup>€</b>
 RUMAR	Adaptador terminal cánula niebla de spray y cirugía. <b>Ø interno:</b> 17mm <b>Ref.: 38-517/5</b>	<b>Pack:</b> 5 unidades <b>18<sup>00</sup>€</b>
 RUMAR	<b>Adaptador aspirasaliva</b> ø11mm a 6,5mm. <b>Ref.: 38-6001</b>	<b>2<sup>00</sup>€</b>
 ***Original***	Adaptador aspirasaliva Cattani® N° 15 de diámetro 11mm a diámetro 6,5mm. <b>***Original Cattani***</b> <b>Ref.: 38-0515</b> (Ref. Cattani®: 1040515)	1 unidad <b>7<sup>00</sup>€</b>
 ***Original***	Adaptador terminal Cattani® de diámetro 16mm a diámetro 11mm <b>***Original Cattani***</b> <b>Ref.: 38-0520</b> (Ref. Cattani®: 1040520)	1 unidad <b>2<sup>80</sup>€</b>
 DÜRR DENTAL	Manguito giratorio 11mm. <b>Ref.: 68-38021</b> (Ref. Dürr®: 7600A010-30)	<b>19<sup>80</sup>€</b>
 DÜRR DENTAL	Manguito giratorio 11mm. <b>Ref.: 68-38022</b> (Ref. Dürr®: 7600A010-07)	<b>9<sup>30</sup>€</b>
 DÜRR DENTAL	Manguito giratorio 16mm. <b>Ref.: 68-38019</b> (Ref. Dürr®: 7600A010-08)	<b>19<sup>80</sup>€</b>
 DÜRR DENTAL	Manguito giratorio 16mm. <b>Ref.: 68-38020</b> (Ref. Dürr®: 7600A010-04)	<b>9<sup>30</sup>€</b>

## Cánulas de aspiración







	Descripción	Observaciones
 	<p>Cánula aspiración universal Petito, 11mm, gris,</p> <p><b>Ref.: 68-38026</b> (Ref. Dürr®: 0700.057.50)</p> <p><b>12'80€</b></p>	<p><b>Para refs.:</b> 68-38021 y 68-38022  <b>Pack:</b> 5 unidades</p> <p><b>HASTA AGOTAR</b></p>
 	<p>Cánula aspiración universal protect, 16mm, gris</p> <p><b>Ref.: 68-38024</b> (Ref. Dürr®: 0700.059.50)</p> <p><b>15'80€</b></p>	<p><b>Para refs.:</b> 68-38019 y 68-38020  <b>Pack:</b> 5 unidades</p> <p><b>HASTA AGOTAR</b></p>
 	<p>Cánula aspiración profilaxis, 16mm, gris</p> <p><b>Ref.: 68-38025</b> (Ref. Dürr®: 0700.058.50)</p> <p><b>17'00€</b></p>	<p><b>Para refs.:</b> 68-38019 y 68-38020  <b>Pack:</b> 4 unidades</p> <p><b>HASTA AGOTAR</b></p>







PR ▶ **PEDALES  
Y SUS REPUESTOS**

# PEDALES FARO®

Pedales Faro®





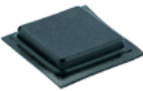



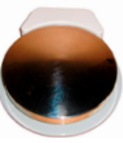

	Descripción	Observaciones
	Pedal P2L1 con cable para Fedesa® con conector  <b>Ref.: 80-224900055</b>	Referencia utilizada por Fedesa®  <b>448<sup>00</sup>€</b>
	Pedal P2L1 con cable para Fedesa®  <b>Ref.: 80-224900050</b>	Referencia utilizada por Fedesa®  <b>418<sup>00</sup>€</b>
	Pedal con cable electropneumático P2L1 Faro®  <b>Ref.: 80-224900000</b>	<b>495<sup>80</sup>€</b>
	Pedal con cable neumático P2L1 Faro®  <b>Ref.: 80-224900100</b>	<b>424<sup>80</sup>€</b>
	Pedal con cable eléctrico P2L1 Faro®  <b>Ref.: 80-224900200</b>	<b>424<sup>80</sup>€</b>
	Carcasa pedal P2L1 (sin movimientos)  <b>Ref.: 80-654905</b> (Ref. Faro®: 224905)	Referencia utilizada por Fedesa®  <b>32<sup>80</sup>€</b>
	Potenciómetro 10K Ohm pedal Faro® y Fedesa®  <b>Ref.: 80-604497</b> (Ref. Faro®: 224497)	Ref. Fedesa®: 244A56  <b>20<sup>80</sup>€</b>

	Descripción	Observaciones
	<p>Potenciometro 2,5K Ohm pedal Faro®</p> <p><b>Ref.: 80-604379</b> (Ref. Faro®: 224379)</p> <p><b>32'80.€</b></p>	
	<p>Válvula FARO® 3 vías accionamiento pedal</p> <p><b>Ref.: 80-604035</b> (Ref. Faro®: 224035)</p> <p><b>31'80.€</b></p>	
	<p>Válvula proporcional flujo de aire pedales Faro® 224900000 y 224900100</p> <p><b>Ref.: 80-604920</b> (Ref. Faro®: 224920)</p> <p><b>90'80.€</b></p>	
	<p>Base pedal P2L1</p> <p><b>Ref.: 80-654901</b> (Ref. Faro®: 224901)</p> <p><b>78'00.€</b></p>	Referencia utilizada por Fedesa®
	<p>Tornillo pedal P2L1</p> <p><b>Ref.: 80-654941</b> (Ref. Faro®: 224941)</p> <p><b>3'80.€</b></p>	Referencia utilizada por Fedesa®
	<p>Cable pedal P2L1</p> <p><b>Ref.: 80-655051</b></p> <p><b>133'80.€</b></p>	Referencia utilizada por Fedesa®
	<p>Base plato pedal Faro®</p> <p><b>Ref.: 80-654954</b> (Ref. Faro®: 224954)</p> <p><b>5'90.€</b></p>	









## Pedales Neumáticos



RUMAR

- Regulación progresiva del flujo de aire.
- Disco de acero de Cromo pulido, muy resistente y duradero.
- Valvulería de primera calidad.
- Con almohadillas antideslizantes.

	Descripción	Observaciones
	Pedal neumático con chip blower y con selector de agua  <b>Ref.: 37-200</b>	*No incluye manguera  <b>118<sup>´</sup>00€</b>
	Pedal neumático sin chip blower y sin selector de agua  <b>Ref.: 37-202</b>	*No incluye manguera  <b>83<sup>´</sup>80€</b>
	Base torre para válvulas con tornillo  <b>Ref.: 37-210</b>	  <b>9<sup>´</sup>80€</b>
	Válvula Hanger con puertos laterales + Pedales neumáticos RUMAR®  <b>Ref.: 37-211</b>	Estado: Normalmente abierta  <b>15<sup>´</sup>80€</b>
	Palanca control de agua  <b>Ref.: 37-212</b>	  <b>6<sup>´</sup>80€</b>
	Base de mandos  <b>Ref.: 37-213</b>	  <b>31<sup>´</sup>80€</b>
	Junta tórica con pasador  <b>Ref.: 37-214</b>	  <b>5<sup>´</sup>80€</b>
	Chip Blower metálico  <b>Ref.: 37-215</b>	  <b>9<sup>´</sup>80€</b>
	Patas de goma  <b>Ref.: 37-216</b>	  <b>2<sup>´</sup>80€</b>

\* VER MANGUERAS PARA PEDALES REFS.: 37-241 Y 44-850

	Descripción	Observaciones	
	Junta interna válvula central  <b>Ref.: 37-217</b>	1'80€	
	Muelle interno válvula central  <b>Ref.: 37-218</b>	4'80€	
	Muelle central válvula central  <b>Ref.: 37-219</b>	7'80€	
	Anillo tórico base  <b>Ref.: 37-220</b>	2'00€	
	Estructura válvula central  <b>Ref.: 37-221</b>	57'80€	
	Junta tórica "U" pistón  <b>Ref.: 37-222</b>	2'00€	
	Pistón sin junta tórica  <b>Ref.: 37-223</b>	11'80€	
	10/32" x 1,6 mm  <b>Ref.: 50-532/5</b>	6'75€	<b>Pack:</b> 5 unidades <b>1,6mm</b> = Tubo diametro interno: 1,4 mm (Ref: 50-10410 y 50-50410)
	Rosca 10/32" y M5.  <b>Ref.: 50-720/10</b>	4'50€	<b>Medidas:</b> 0,79x0,475x0,08mm <b>Pack:</b> 10 unidades
	10/32" x 3,2 mm  <b>Ref.: 50-530/5</b>	6'50€	<b>Pack:</b> 5 unidades <b>3,2mm</b> = Tubo diametro interno: 4mm (Ref: 50-100 y 50-10025)

	Descripción	Observaciones
	Disco metálico válvulas  Ref.: 37-224	3 <sup>00</sup> €
	Torre completa palanca control de agua  Ref.: 37-225	31 <sup>80</sup> €
	Torre completa Chip-Blower  Ref.: 37-226	38 <sup>00</sup> €

**IMPORTANTE:**

Válvula central completa = 37-217 + 37-218 + 37-220 + 37-221 + 37-222 + 37-223

RCE

## ▶ RACORES, CONECTORES Y ESPIGAS

- Racorería, conectores y llaves de paso
- Espigas
- Conectores de Nylon

RUMAR

*DCI*



# RACORERÍA

- Conexión rápida, serie SC.
- Latón niquelado.
- Primera calidad.





## Rectos macho cónico

RUMAR

	Descripción		Observaciones
	3/8" x 8 mm. <b>Ref.: 50-009/5</b>	<b>11'80€</b>	<b>Pack:</b> 5 unidades
	1/4" x 6 mm. <b>Ref.: 50-001/5</b>	<b>8'80€</b>	<b>Pack:</b> 5 unidades
	1/4" x 8 mm. <b>Ref.: 50-002/5</b>	<b>8'80€</b>	<b>Pack:</b> 5 unidades
	1/8" x 6 mm. <b>Ref.: 50-003/5</b>	<b>6'00€</b>	<b>Pack:</b> 5 unidades
	1/8" x 8 mm. <b>Ref.: 50-004/5</b>	<b>7'00€</b>	<b>Pack:</b> 5 unidades

## Rectos hembra



RUMAR

	Descripción		Observaciones
	1/4" x 6 mm. <b>Ref.: 50-005/5</b>	<b>10'70€</b>	<b>Pack:</b> 5 unidades
	1/4" x 8 mm. <b>Ref.: 50-006/5</b>	<b>10'50€</b>	<b>Pack:</b> 5 unidades
	1/8" x 6 mm. <b>Ref.: 50-007/5</b>	<b>8'80€</b>	<b>Pack:</b> 5 unidades
	1/8" x 8 mm. <b>Ref.: 50-008/5</b>	<b>8'80€</b>	<b>Pack:</b> 5 unidades

## Codos fijos, macho



RUMAR

	Descripción		Observaciones
	1/4" x 6 mm. <b>Ref.: 50-011/5</b>	<b>8'80€</b>	<b>Pack:</b> 5 unidades

	Descripción	Observaciones
	1/4" x 8 mm. <b>Ref.: 50-012/5</b>	<b>Pack:</b> 5 unidades <b>9'70€</b>
	1/8" x 6 mm. <b>Ref.: 50-013/5</b>	<b>Pack:</b> 5 unidades <b>8'10€</b>
	1/8" x 8 mm. <b>Ref.: 50-014/5</b>	<b>Pack:</b> 5 unidades <b>8'90€</b>



Codos fijos, hembra

RUMAR

	Descripción	Observaciones
	1/4" x 6 mm. <b>Ref.: 50-015/5</b>	<b>Pack:</b> 5 unidades <b>13'90€</b>
	1/4" x 8 mm. <b>Ref.: 50-016/5</b>	<b>Pack:</b> 5 unidades <b>15'00€</b>
	1/8" x 6 mm. <b>Ref.: 50-091/5</b>	<b>Pack:</b> 5 unidades <b>11'50€</b>
	1/8" x 8 mm. <b>Ref.: 50-092/5</b>	<b>Pack:</b> 5 unidades <b>12'30€</b>



Codos Intermedios

RUMAR

	Descripción	Observaciones
	6 x 6 mm. <b>Ref.: 50-021/5</b>	<b>Pack:</b> 5 unidades <b>13'20€</b>
	8 x 8 mm. <b>Ref.: 50-022/5</b>	<b>Pack:</b> 5 unidades <b>15'60€</b>

Prolongadores



RUMAR

	Descripción	Observaciones
	6 x 6 mm. <b>Ref.: 50-025/5</b>	<b>Pack:</b> 5 unidades <b>9'70€</b>
	8 x 8 mm. <b>Ref.: 50-026/5</b>	<b>Pack:</b> 5 unidades <b>11'40€</b>

	Descripción	Observaciones
	6 x 8 mm. <b>Ref.: 50-027/5</b>	<b>Pack:</b> 5 unidades <b>12'80€</b>



## "T" Intermedias

RUMAR

	Descripción	Observaciones
	6 x 6 x 6 mm. <b>Ref.: 50-031/5</b>	<b>Pack:</b> 5 unidades <b>17'80€</b>
	8 x 8 x 6 mm. <b>Ref.: 50-033/5</b>	<b>Pack:</b> 5 unidades <b>20'30€</b>
	8 x 8 x 8 mm. <b>Ref.: 50-032/5</b>	<b>Pack:</b> 5 unidades <b>20'70€</b>



## "T" Lateral macho cónico

RUMAR

	Descripción	Observaciones
	1/4" x 6 x 6 mm. <b>Ref.: 50-035</b>	<b>3'10€</b>
	1/4" x 8 x 8 mm. <b>Ref.: 50-036</b>	<b>3'50€</b>



## "T" Central macho cónico

RUMAR

	Descripción	Observaciones
	1/4" x 6 x 6 mm. <b>Ref.: 50-041</b>	<b>3'00€</b>
	1/4" x 8 x 8 mm. <b>Ref.: 50-042</b>	<b>3'50€</b>

## Cruz intermedia





RUMAR

	Descripción	Observaciones
	6 x 6 x 6 x 6 mm. <b>Ref.: 50-045</b>	<b>5'30€</b>
	8 x 8 x 8 x 8 mm. <b>Ref.: 50-046</b>	<b>6'20€</b>

## CONECTORES RÁPIDOS AIRE EASY

### Rectos macho

RUMAR



	Descripción	Observaciones
	1/4" x 8 mm. <b>Ref.: 50-070/5</b>	<b>Pack:</b> 5 unidades <b>11'25€</b>
	1/4" x 6 mm. <b>Ref.: 50-071/5</b>	<b>Pack:</b> 5 unidades <b>11'80€</b>
	1/8" x 8 mm. <b>Ref.: 50-072/5</b>	<b>Pack:</b> 5 unidades <b>12'30€</b>
	1/8" x 6 mm. <b>Ref.: 50-073/5</b>	<b>Pack:</b> 5 unidades <b>10'80€</b>

## UNIONES RÁPIDAS ENGANCHE METÁLICO

SISTEMA ANTI ESCAPE DE TUBOS - MAYOR DURABILIDAD



### Uniones

RUMAR

	Descripción	Observaciones
	4 x 4 mm. <b>Ref.: 50-087/5</b>	<b>Pack:</b> 5 unidades <b>15'20€</b>
	6 x 6 mm. <b>Ref.: 50-081/5</b>	<b>Pack:</b> 5 unidades <b>16'50€</b>
	8 x 8 mm. <b>Ref.: 50-082/5</b>	<b>Pack:</b> 5 unidades <b>19'00€</b>



### Uniones reductoras

RUMAR

	Descripción	Observaciones
	6 x 8 mm. <b>Ref.: 50-083/5</b>	<b>Pack:</b> 5 unidades <b>19'80€</b>
	4 x 6 mm. <b>Ref.: 50-088/5</b>	<b>Pack:</b> 5 unidades <b>18'80€</b>

## "T" Intermedias

RUMAR





	Descripción	Observaciones
	8 x 8 x 8 mm. <b>Ref.: 50-080/5</b>	<b>Pack:</b> 5 unidades <b>30<sup>´</sup>20€</b>
	6 x 6 x 6 mm. <b>Ref.: 50-084/5</b>	<b>Pack:</b> 5 unidades <b>27<sup>´</sup>40€</b>

## Conectores Rápidos Agua/Aire DCI

	Descripción	Observaciones
	Hembra conexión rápida para tubo de <b>4x6mm</b> . <b>***Original DCI***</b> <b>Ref.: 50-0011</b>	<b>Suministros incluye:</b> arandelas de colores para identificación. <b>Aire o Agua</b> <b>20<sup>´</sup>80€</b>
	Macho conexión rápida para tubo de <b>4x6mm</b> . <b>***Original DCI***</b> <b>Ref.: 50-0014</b>	<b>Aire o Agua</b> <b>20<sup>´</sup>80€</b>
	Conexión rápida macho agua / aire para tubo de <b>4x6mm</b> . <b>Ref.: 28-U054</b>	<b>Aire o agua</b> Compatible con conexión de entrada de agua de red del PT-A <b>9<sup>´</sup>80€</b>
	Conexión rápida hembra agua / aire para tubo de <b>4x6mm</b> . <b>Ref.: 28-U055</b>	<b>Aire o agua</b> <b>9<sup>´</sup>80€</b>
	Conexión rápida macho agua / aire tubo de <b>4x6mm</b> <b>Ref.: 28-U073</b>	<b>Aire o agua</b> <b>9<sup>´</sup>80€</b>

## Accesorios

RUMAR

	Descripción	Observaciones
	Válvula Antirretorno 1/4" x 1/4", hembra / hembra. <b>Ref.: 50-061</b>	<b>8<sup>´</sup>00€</b>
	Válvula Antirretorno 1/8" x 1/8", hembra / hembra. <b>Ref.: 50-066</b>	<b>7<sup>´</sup>00€</b>
	Mini válvula Antirretorno 10/32" x 1,6mm. <b>Ref.: 50-570</b>	<b>7<sup>´</sup>80€</b> <b>HASTA AGOTAR</b>
	Mini válvula Antirretorno 1,6mm x 1,6mm. <b>Ref.: 50-571</b>	<b>7<sup>´</sup>80€</b>
	Mini válvula Antirretorno M5 x M5, hembra / hembra <b>Ref.: 50-572</b>	(Ref: Fedesa® 247A18) <b>12<sup>´</sup>80€</b>



## Pasatabiques

RUMAR

	Descripción	Observaciones
	Pasatabiques 1/8" x 1/8", macho / hembra. <b>Ref.: 50-090/5</b>	<b>Pack:</b> 5 unidades (Ref. Fedesa® 575A66) <b>11'80€</b>









## Uniones

RUMAR



	Descripción	Observaciones
	Unión 1/4" x 1/4", macho / macho. <b>Ref.: 50-085/5</b>	<b>Pack:</b> 5 unidades <b>5'40€</b>
	Unión 1/8" x 1/8", macho / macho. <b>Ref.: 50-086/5</b>	<b>Pack:</b> 5 unidades <b>3'70€</b>
	Unión 1/8" x 1/8", hembra / macho. <b>Ref.: 50-089/5</b>	<b>Pack:</b> 5 unidades (Ref. Fedesa® 575A31) <b>4'80€</b>

## Reductores



RUMAR

	Descripción	Observaciones
	Reductor 1/4" macho x 1/8" hembra. <b>Ref.: 50-062/5</b>	<b>Pack:</b> 5 unidades <b>4'50€</b>
	Reductor 3/8" macho x 1/4" hembra. <b>Ref.: 50-064/5</b>	<b>Pack:</b> 5 unidades <b>5'60€</b>
	Reductor 1/2" macho x 1/4" hembra. <b>Ref.: 50-067/5</b>	<b>Pack:</b> 5 unidades <b>9'80€</b>
	Reductor 1/8" macho x 10/32" hembra. <b>Ref.: 50-565/5</b>	<b>Pack:</b> 5 unidades <b>35'80€</b>
	Reductor 1/8" macho x M5 hembra. <b>Ref.: 50-060/5</b>	<b>Pack:</b> 5 unidades (Ref. Fedesa® 575A49) <b>3'80€</b>
	Reductor 1/8" macho x 1/4" hembra. <b>Ref.: 50-063/5</b>	<b>Pack:</b> 5 unidades <b>6'40€</b>
	Reductor 1/2" hembra x 1/4" hembra. <b>Ref.: 50-069/5</b>	<b>Pack:</b> 5 unidades (Ref. Fedesa® 575A85) <b>11'80€</b>
	Reductor 1/4" macho x 3/8" hembra. <b>Ref.: 50-068/5</b>	<b>Pack:</b> 5 unidades <b>10'80€</b>





## Codos fijos

	Descripción	Observaciones
	Codo 3/8" x 3/8", hembra / macho. <b>Ref.: 50-094/5</b>	<b>Pack:</b> 5 unidades (Ref. Fedesa® 575A122) <b>16<sup>80</sup>€</b>
	Codo 1/4" x 1/4", hembra / macho. <b>Ref.: 50-095/5</b>	<b>Pack:</b> 5 unidades <b>11<sup>80</sup>€</b>
	Codo 1/8" x 1/8", hembra / macho. <b>Ref.: 50-096/5</b>	<b>Pack:</b> 5 unidades <b>8<sup>80</sup>€</b>



## "T" central

	Descripción	Observaciones
	"T" 1/4" macho a 2x 1/4" hembra <b>Ref.: 50-093/5</b>	<b>Pack:</b> 5 unidades <b>14<sup>80</sup>€</b>
	"T" 1/8" macho a 2x 1/8" hembra <b>Ref.: 50-097/5</b>	<b>Pack:</b> 5 unidades (Ref. Fedesa® 575A59) <b>11<sup>80</sup>€</b>









## Llaves de paso



	Descripción	Observaciones
	Llave de paso 1/2" x 1/2" macho / hembra <b>Ref.: 50-254</b>	(Ref. Fedesa® 770A16) <b>8<sup>00</sup>€</b>
	Llave de paso 1/4" x 1/4" macho / macho. <b>Ref.: 50-250</b>	<b>8<sup>10</sup>€</b>
	Llave de paso 1/4" x 1/4" macho / hembra. <b>Ref.: 50-251</b>	<b>6<sup>70</sup>€</b>
	Llave de paso 1/4" x 1/4" hembra / hembra. <b>Ref.: 50-252</b>	<b>8<sup>50</sup>€</b>
	Llave de paso 1/8" x 1/8" macho / hembra. <b>Ref.: 50-253</b>	<b>8<sup>00</sup>€</b>

Varios

	Llave de retención compresores 3/8" <b>Ref.: 50-258</b>	12 <sup>80</sup> €	(Ref. Fedesa® 175A35)
	Grifo purga 1/4", cierre tórica <b>Ref.: 50-259/5</b>	14 <sup>80</sup> €	<b>Pack:</b> 5 unidades (Ref. Fedesa® 415A11)





Espigas manguera, macho

	Descripción		Observaciones
	1/4" x 6 mm. <b>Ref.: 50-051/5</b>	5 <sup>90</sup> €	<b>Pack:</b> 5 unidades
	1/4" x 8 mm. <b>Ref.: 50-052/5</b>	6 <sup>40</sup> €	<b>Pack:</b> 5 unidades
	1/4" x 12 mm. <b>Ref.: 50-050/5</b>	6 <sup>80</sup> €	<b>Pack:</b> 5 unidades
	1/8" x 6 mm. <b>Ref.: 50-053/5</b>	5 <sup>20</sup> €	<b>Pack:</b> 5 unidades
	1/8" x 8 mm. <b>Ref.: 50-054/5</b>	5 <sup>20</sup> €	<b>Pack:</b> 5 unidades
	3/8" x 12 mm. <b>Ref.: 50-057/5</b>	8 <sup>80</sup> €	<b>Pack:</b> 5 unidades (Ref. Fedesa® 575A121)
	3/8" x 18 mm. <b>Ref.: 50-058/5</b>	12 <sup>80</sup> €	<b>Pack:</b> 5 unidades (Ref. Fedesa® 575A120)
	10/32" x 3,2 mm <b>Ref.: 50-530/5</b>	6 <sup>50</sup> €	<b>Pack:</b> 5 unidades 3,2mm = Tubo diametro interno: 4mm (Ref.: 50-100 y 50-10025)
	10/32" x 2,5 mm <b>Ref.: 50-542/5</b>	6 <sup>50</sup> €	<b>Pack:</b> 5 unidades 2,5mm = Tubo diametro interno: 2,8 mm (Ref.: 50-50310 y 50-60310)
	10/32" x 1,6 mm <b>Ref.: 50-532/5</b>	6 <sup>75</sup> €	<b>Pack:</b> 5 unidades 1,6mm = Tubo diametro interno: 1,4 mm (Ref.: 50-10410 y 50-50410)
	M5 x 3,2 mm <b>Ref.: 50-540/5</b>	6 <sup>50</sup> €	<b>Pack:</b> 5 unidades 3,2mm = Tubo diametro interno: 4mm (Ref.: 50-100 y 50-10025)

	Descripción	Observaciones
	M5 x 1,6 mm <b>Ref.: 50-541/5</b>	<b>Pack:</b> 5 unidades <b>1,6mm</b> = Tubo diámetro interno: 1,4 mm (Ref.: 50-10410 y 50-50410) <b>6'50€</b>
	10/32" x 3,2 mm <b>Ref.: 50-537/5</b>	<b>Rosca extra larga</b> <b>Pack:</b> 5 unidades <b>3,2mm</b> = Tubo diámetro interno: 4mm (Ref.: 50-100 y 50-10025) <b>6'50€</b>
	10/32" x 1,6 mm <b>Ref.: 50-538/5</b>	<b>Rosca extra larga</b> <b>Pack:</b> 5 unidades <b>1,6mm</b> = Tubo diámetro interno: 1,4 mm (Ref.: 50-10410 y 50-50410) <b>6'75€</b>
	8/32" x 1,6 mm <b>Ref.: 50-543/5</b>	<b>Pack:</b> 5 unidades <b>1,6mm</b> = Tubo diámetro interno: 1,4 mm (Ref.: 50-10410 y 50-50410) <b>6'50€</b>



Uniones macho / macho

RUMAR

	Descripción	Observaciones
	Reductora 3,2mm a 2,5mm <b>Ref.: 50-533/5</b>	<b>Pack:</b> 5 unidades <b>3,2mm</b> = Tubo diámetro interno: 4mm (Ref.: 50-100 y 50-10025) <b>2,5mm</b> = Tubo diámetro interno: 2,8 mm (Ref.: 50-50310 y 50-60310) <b>10'00€</b>
	Reductora 3,2mm a 1,6mm <b>Ref.: 50-534/5</b>	<b>Pack:</b> 5 unidades <b>3,2mm</b> = Tubo diámetro interno: 4mm (Ref.: 50-100 y 50-10025) <b>1,6mm</b> = Tubo diámetro interno: 1,4 mm (Ref.: 50-10410 y 50-50410) <b>12'00€</b>
	Reductora 2,5mm a 1,6mm <b>Ref.: 50-535/5</b>	<b>Pack:</b> 5 unidades <b>2,5mm</b> = Tubo diámetro interno: 2,8 mm (Ref.: 50-50310 y 50-60310) <b>1,6mm</b> = Tubo diámetro interno: 1,4 mm (Ref.: 50-10410 y 50-50410) <b>12'00€</b>
	Uniones 1,6mm a 1,6mm <b>Ref.: 50-536/5</b>	<b>Pack:</b> 5 unidades <b>1,6mm</b> = Tubo diámetro interno: 1,4 mm (Ref.: 50-10410 y 50-50410) <b>12'00€</b>



Tapón macho

RUMAR

	Descripción	Observaciones
	Tapón macho 1/4" con tórica x Allen. <b>Ref.: 50-055/5</b>	<b>Pack:</b> 5 unidades <b>4'70€</b>
	Tapón macho 1/8" x hexagonal. <b>Ref.: 50-056/5</b>	<b>Pack:</b> 5 unidades <b>3'70€</b>
	Tapón macho 10/32" x hexagonal. <b>Ref.: 50-539/5</b>	<b>Pack:</b> 5 unidades <b>3'75€</b>



## Abrazaderas de seguridad de metal

RUMAR

	Descripción	Observaciones
	Abrazadera de seguridad de metal para tubo de 1,6x2,5mm. <b>Ref.: 50-550</b>	0'75€
	Abrazadera de seguridad de metal para tubo de 2,5x4mm. <b>Ref.: 50-551</b>	0'30€ <b>HASTA AGOTAR</b>

## Junta de Nylon

RUMAR





	Descripción	Observaciones
	Rosca 10/32" y M5. <b>Ref.: 50-720/10</b>	Medidas: 0,79x0,475x0,08mm Pack: 10 unidades 4'50€
	Rosca #6. <b>Ref.: 50-721/10</b>	Medidas: 0,79x0,353x0,08mm Pack: 10 unidades 4'50€
	Rosca #8. <b>Ref.: 50-722/10</b>	Medidas: 0,63x0,41x0,08mm Pack: 10 unidades 4'50€

## TUBOS

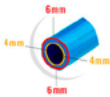
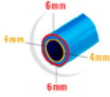
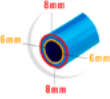
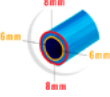
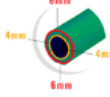
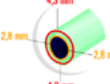
## Poliuretano

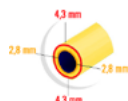
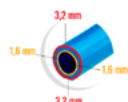
RUMAR

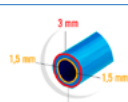
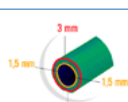
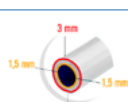

	Descripción	Observaciones
	Tubo poliuretano aire / agua, 4 x 6 mm (máx 10 bar) <b>Azul</b> <b>Ref.: 50-100</b>	Por metro -Compra mín. 10m / múltiplo de 5m NO ADMITEN DEVOLUCIÓN 1'90€
	Tubo poliuretano aire / agua, 4 x 6 mm (máx 10 bar) <b>Azul</b> <b>Ref.: 50-10025</b>	Caja 25 metros 30'80€
	Tubo poliuretano aire / agua, 6 x 8 mm (máx 20 bar) <b>Azul</b> <b>Ref.: 50-101</b>	Por metro -Compra mín. 10m / múltiplo de 5m NO ADMITEN DEVOLUCIÓN 2'10€
	Tubo poliuretano aire / agua, 6 x 8 mm (máx 20 bar) <b>Azul</b> <b>Ref.: 50-10125</b>	Caja 25 metros 36'80€
	Tubo poliuretano aire / agua, 4 x 6 mm (máx 10 bar) <b>Verde</b> <b>Ref.: 50-20025</b>	Caja 25 metros Especialmente diseñada para agua. Mayor resistencia. (Ref. Fedesa® 733A65) 36'80€
	Tubo poliuretano aire / agua, 2,8 x 4,3 mm <b>Verde transparente</b> <b>Ref.: 50-50310</b>	Rollo 10 metros NO ADMITEN DEVOLUCIÓN 28'00€ <b>HASTA AGOTAR</b>

	Descripción	Observaciones
	Tubo poliuretano aire / agua, 2,8 x 4,3 mm <b>Amarillo</b> Ref.: <b>50-60310</b>	Rollo 10 metros NO ADMITEN DEVOLUCIÓN HASTA AGOTAR
	Tubo poliuretano aire / agua, 1,6 x 3,2 mm <b>Azul</b> Ref.: <b>50-10410</b>	Rollo 10 metros NO ADMITEN DEVOLUCIÓN
	Tubo poliuretano aire / agua, 1,6 x 3,2 mm <b>Verde transparente</b> Ref.: <b>50-50410</b>	Rollo 10 metros NO ADMITEN DEVOLUCIÓN
	Tubo poliuretano aire / agua, 1,5 x 3 mm <b>Azul</b> Ref.: <b>50-10210</b>	Rollo 10 metros (Ref. Fedesa® 733A72) NO ADMITEN DEVOLUCIÓN
	Tubo poliuretano aire / agua, 1,5 x 3 mm <b>Verde</b> Ref.: <b>50-20210</b>	Rollo 10 metros (Ref. Fedesa® 733A75) NO ADMITEN DEVOLUCIÓN
	Tubo poliuretano aire / agua, 1,5 x 3 mm <b>Transparente</b> Ref.: <b>50-40210</b>	Rollo 10 metros (Ref. Fedesa® 733A78) NO ADMITEN DEVOLUCIÓN
	Pinza cortatubos, modelo PT Ref.: <b>50-065</b>	12´40€

## CONECTORES DE NYLON





### Uniones

RUMAR

	Descripción	Observaciones
	1,6 X 1,6 mm. Ref.: <b>50-300</b>	Pack: 10 unidades 10´80€
	2,4 X 2,4 mm. Ref.: <b>50-301</b>	Pack: 10 unidades 10´80€
	3,2 X 3,2 mm. Ref.: <b>50-302</b>	Pack: 10 unidades 10´80€



## Uniones reductoras

RUMAR

	Descripción		Observaciones
	4 x 1,6 mm. Ref.: 50-350	11'80€	Pack: 10 unidades
	4 mm x 2,4 mm. Ref.: 50-351	11'80€	Pack: 10 unidades
	3,2 x 1,6 mm. Ref.: 50-352	9'80€	Pack: 10 unidades
	3,2 x 2,4 mm. Ref.: 50-353	9'80€	Pack: 10 unidades



## "T"



RUMAR

	Descripción		Observaciones
	1,6 x 1,6 X 1,6 mm. Ref.: 50-320	13'80€	Pack: 10 unidades
	2,4 x 2,4 X 2,4 mm. Ref.: 50-321	13'80€	Pack: 10 unidades
	3,2 x 3,2 X 3,2 mm. Ref.: 50-322	13'80€	Pack: 10 unidades

## "T" reductora

RUMAR

	Descripción		Observaciones
	2 x 3,2mm + 1 x 1,6mm. Ref.: 50-323	14'30€	Pack: 10 unidades
	2 x 3,2mm + 1 x 2,4 mm. Ref.: 50-324	14'30€	Pack: 10 unidades

	Descripción		Observaciones
	1,6 x 1,6 x 1,6 X 1,6 mm. <b>Ref.: 50-340</b>	<b>18'20€</b>	<b>Pack:</b> 10 unidades <b>HASTA AGOTAR</b>
	2,4 x 2,4 x 2,4 X 2,4 mm. <b>Ref.: 50-341</b>	<b>18'20€</b>	<b>Pack:</b> 10 unidades <b>HASTA AGOTAR</b>
	3,2 x 3,2 x 3,2 X 3,2 mm. <b>Ref.: 50-342</b>	<b>18'20€</b>	<b>Pack:</b> 10 unidades <b>HASTA AGOTAR</b>

## VE ▶ VÁLVULAS Y ELECTROVÁLVULAS

- Válvulas (Faro®, Clippard®, RUMAR®)
- Electroválvulas (Sirai® / ASCO® NEUMATICS)



*Clippard* RUMAR









ASCO™

# VÁLVULAS







## Válvulas FARO®



	Descripción	Observaciones
	Válvula agua selección de instrumentos  <b>Ref.: 80-603400</b> (Ref. Faro®: 223400)	<b>55'80€</b>
	Válvula 3 vías accionamiento pedal  <b>Ref.: 80-604035</b> (Ref. Faro®: 224035)	<b>31'80€</b>
	Válvula apertura agua con aspiración  <b>Ref.: 80-604639</b> (Ref. Faro®: 224639)	<b>88'00€</b>
	Válvula agua comando aire  <b>Ref.: 80-604679</b> (Ref. Faro®: 224679)	<b>101'80€</b>
	Distribuidor  <b>Ref.: 80-604248</b> (Ref. Faro®: 234248)	<b>76'80€</b> <b>Entrada:</b> 1x3,2mm <b>Salidas:</b> 3x1,6mm
	Válvula proporcional flujo de aire pedales Faro® 224900000 y 224900100  <b>Ref.: 80-604920</b> (Ref. Faro®: 224920)	<b>90'80€</b>
	Membrana válvula agua  <b>Ref.: 80-603033</b> (Ref. Faro®: 223033)	<b>4'80€</b>
	Membrana válvula neumática instrumento  <b>Ref.: 80-603147</b> (Ref. Faro®: 223147)	<b>4'40€</b>
	Membrana válvula eléctrica instrumento  <b>Ref.: 80-603252</b> (Ref. Faro®: 223252)	<b>5'60€</b>

OTRAS REFERENCIAS DISPONIBLES CONSÚLTANOS







SI NO ENCUENTRAS EL REPUESTO QUE BUSCAS, ¡CONSÚLTANOS!  
 Precios: impuestos, portes y mano de obra no incluidos.

	Descripción	Observaciones
	Válvula solenoide  <b>Ref.: 80-603162</b> (Ref. Faro®: 223162)	<b>Voltaje:</b> 24V DC / CC <b>Potencia:</b> 1,3W <b>Estado:</b> normalmente abierta <b>Presión Máx.:</b> 7 bar  <b>54<sup>80</sup>€</b>
	Válvula solenoide  <b>Ref.: 80-603164</b> (Ref. Faro®: 223164)	<b>Voltaje:</b> 24V AC / CA 50/60 Hz <b>Potencia:</b> 1,3W <b>Estado:</b> normalmente abierta <b>Presión Máx.:</b> 7 bar  <b>56<sup>80</sup>€</b>
	Interruptor electroneumático  <b>Ref.: 80-654331</b> (Ref. Faro®: 224331)	          <b>34<sup>80</sup>€</b>
	Válvula doble, un sentido  <b>Ref.: 80-604265</b> (Ref. Faro®: 224265)	          <b>50<sup>80</sup>€</b>
	Llave de regulación FARO® aire/agua  <b>Ref.: 80-608030</b> (Ref. Faro®: 118030)	<b>Conexiones:</b> 1,6mm <b>Con empuñadura</b>          <b>47<sup>80</sup>€</b>
	Llave de regulación aire/agua  <b>Ref.: 80-607070</b> (Ref. Faro®: 117070)	<b>Conexiones:</b> 1,6mm <b>Sin empuñadura</b>          <b>26<sup>80</sup>€</b>
	Llave de regulación aire/agua  <b>Ref.: 80-600367</b> (Ref. Faro®: 200367)	<b>Conexiones:</b> 2,6mm <b>Sin empuñadura</b>          <b>25<sup>80</sup>€</b>
	Llave de regulación aire/agua  <b>Ref.: 80-604170</b> (Ref. Faro®: 224170)	<b>Conexiones:</b> 3,2mm <b>Sin empuñadura</b>          <b>26<sup>80</sup>€</b>

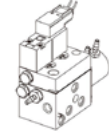
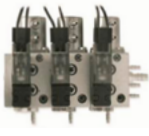
OTRAS REFERENCIAS DISPONIBLES CONSÚLTANOS

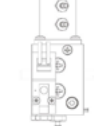
Bloques válvulas FARO®

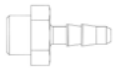

	Descripción	Observaciones
	<p>Bloque 3 instrumentos (operación eléctrica)</p> <p>También disponible para 1 o 2 instrumentos y sin tapa de cierre. Consultar</p> <p><b>Ref.: 80-603300</b> (Ref. Faro®: 223300)</p>	<p><b>Voltaje: 24V DC / CC</b></p>
	<p>Módulo de ampliación de bloques Faro® (operación eléctrica)</p> <p><b>Ref.: 80-603250</b> (Ref. Faro®: 223250)</p>	<p><b>Voltaje: 24V DC / CC</b></p>
	<p>Bloque 3 instrumentos (operación eléctrica)</p> <p>También disponible para 1 o 2 instrumentos y sin tapa de cierre. Consultar</p> <p><b>Ref.: 80-603305</b> (Ref. Faro®: 223305)</p>	<p><b>Voltaje: 24V AC / CA</b></p> <p>Referencia utilizada por Fedesa®</p>
	<p>Bloque 2 instrumentos (operación eléctrica)</p> <p><b>Ref.: 80-603296</b> (Ref. Faro®: 223296)</p>	<p><b>Voltaje: 24V AC / CA</b></p> <p>Referencia utilizada por Fedesa®</p>
	<p>Módulo de ampliación de bloques Faro® (operación eléctrica)</p> <p><b>Ref.: 80-603255</b> (Ref. Faro®: 223255)</p>	<p><b>Voltaje: 24V AC / CA</b></p> <p>Referencia utilizada por Fedesa®</p>
	<p>Bloque 4 vías, 3 instrumentos (operación neumática)</p> <p>También disponible para 1 o 2 instrumentos y sin tapa de cierre. Consultar</p> <p><b>Ref.: 80-603345</b> (Ref. Faro®: 223345)</p>	<p>Referencia utilizada por Fedesa®</p>
	<p>Bloque 2 instrumentos (operación neumática)</p> <p><b>Ref.: 80-603149</b> (Ref. Faro®: 223149)</p>	<p>Referencia utilizada por Fedesa®</p>
	<p>Módulo de ampliación de bloques Faro® (operación neumática)</p> <p><b>Ref.: 80-603201</b> (Ref. Faro®: 223201)</p>	<p>Referencia utilizada por Fedesa®</p>
	<p>Espiga para bloques y válvulas Faro® tubo 2,6mm/3,2mm</p> <p><b>Ref.: 80-600128</b> (Ref. Faro®: 250128)</p>	<p><b>4´80€</b></p>
	<p>Espiga para bloques y válvulas Faro® tubo 1,5mm/2,0mm</p> <p><b>Ref.: 80-600129</b> (Ref. Faro®: 250129)</p>	<p><b>4´80€</b></p>

OTRAS REFERENCIAS DISPONIBLES CONSÚLTANOS

SI NO ENCUENTRAS EL REPUESTO QUE BUSCAS, ¡CONSÚLTANOS!  
 Precios: impuestos, portes y mano de obra no incluidos.

Ampliación de bloques FARO® (Ver páginas siguientes)



	Descripción	Observaciones
	<p>Junta de Nylon para espigas bloques y válvulas Faro®</p> <p><b>Ref.: 80-600131</b> (Ref. Faro®: 250131)</p> <p style="text-align: right;"><b>1'20€</b></p>	
	<p>Tuerca ampliación bloques Faro®</p> <p><b>Ref.: 80-609025</b> (Ref. Faro®: 609025)</p> <p style="text-align: right;"><b>1'30€</b></p>	
	<p>Tornillo ampliación bloques Faro®</p> <p><b>Ref.: 80-603208</b> (Ref. Faro®: 223208)</p> <p style="text-align: right;"><b>4'00€</b></p>	<p><b>Largo: 33mm (+1 puesto)</b></p>
	<p>Tornillo ampliación bloques Faro®</p> <p><b>Ref.: 80-603166</b> (Ref. Faro®: 223166)</p> <p style="text-align: right;"><b>4'90€</b></p>	<p><b>Largo: 55mm (+2 puestos)</b></p>
	<p>Anillo tórico bloques Faro®</p> <p><b>Ref.: 80-605019</b> (Ref. Faro®: 055019)</p> <p style="text-align: right;"><b>1'20€</b></p>	

OTRAS REFERENCIAS DISPONIBLES CONSÚLTANOS

## AMPLIACIÓN BLOQUE NEUMÁTICO:

80-603345

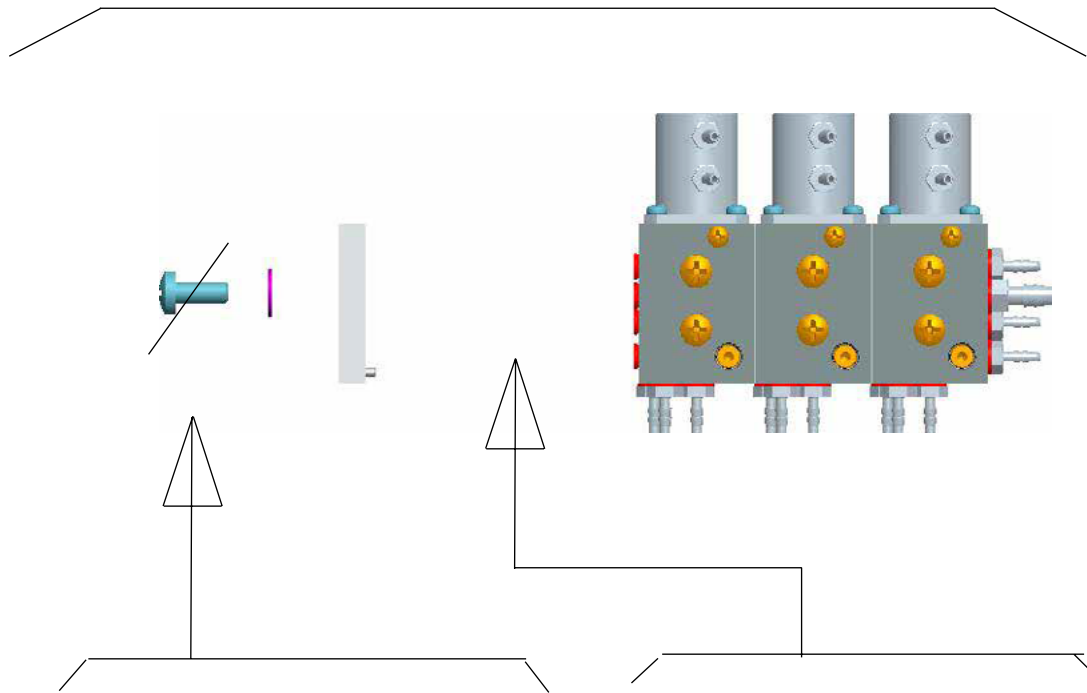

80-609025

80-603208  
(+1 PUESTO)

80-605019

80-603201

80-603166  
(+2 PUESTO)

## AMPLIACIÓN BLOQUE ELÉCTRICO CA/AC:

80-603305

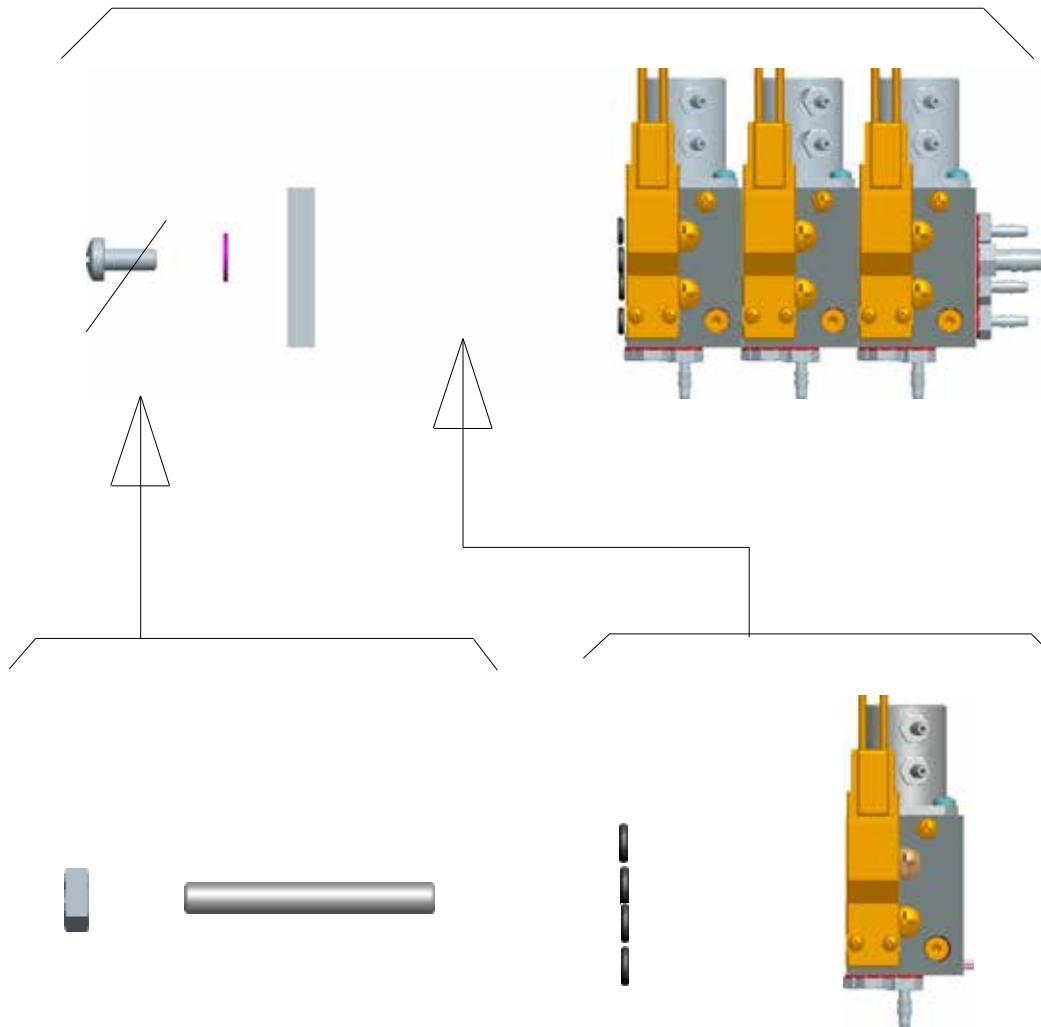

80-609025

80-603208  
(+1 PUESTO)

80-605019

80-603255

80-603166  
(+2 PUESTO)

## AMPLIACIÓN BLOQUE ELÉCTRICO CC/DC:

80-603300

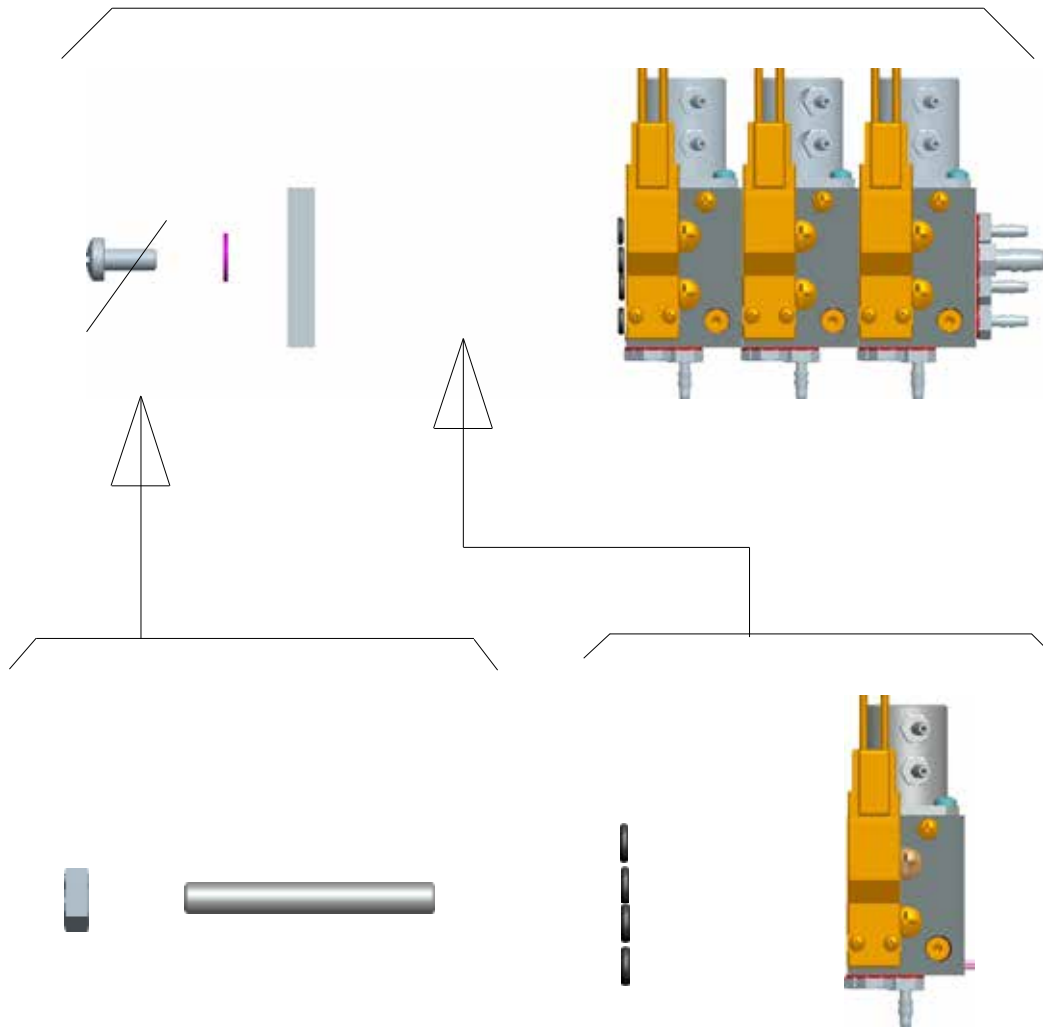

80-609025

80-603208  
(+1 PUESTO)

80-605019

80-603250

80-603166  
(+2 PUESTO)

Válvulas bloques RUMAR®

RUMAR

- Primera calidad.
- Acabados y tolerancias según normas DIN.
- **Garantía** 6 meses.

	Descripción	Observaciones
	Válvula bloque RUMAR® 3 instrumentos, <b>tipo DCI</b>  <b>Ref.: VE-703</b>	<b>Conexiones:</b> 10/32" Incluye espigas  <b>88<sup>00</sup>€</b>
	Válvula bloque RUMAR® 4 instrumentos, <b>tipo DCI</b>  <b>Ref.: VE-704</b>	<b>Conexiones:</b> 10/32" Incluye espigas  <b>94<sup>80</sup>€</b>
	Válvula bloque RUMAR® 3 instrumentos, <b>Standard</b>  <b>Ref.: VE-713</b>	<b>Conexiones:</b> 10/32" Incluye espigas  <b>88<sup>00</sup>€</b>
	Válvula bloque RUMAR® 4 instrumentos, <b>Standard</b>  <b>Ref.: VE-714</b>	<b>Conexiones:</b> 10/32" Incluye espigas  <b>94<sup>80</sup>€</b>

Membranas bloques RUMAR®



RUMAR

	Descripción	Observaciones
	Membrana bloque RUMAR® 3 instrumentos, <b>tipo DCI (Ref.: VE-703)</b>  <b>Ref.: VE-7031</b>	<b>14<sup>80</sup>€</b>
	Membrana bloque RUMAR® 4 instrumentos, <b>tipo DCI (Ref.: VE-704)</b>  <b>Ref.: VE-7041</b>	<b>14<sup>80</sup>€</b>
	Membrana bloque RUMAR® 3 instrumentos, <b>Standard (Ref.: VE-713)</b>  <b>Ref.: VE-7131</b>	<b>14<sup>80</sup>€</b>
	Membrana bloque RUMAR® 4 instrumentos, <b>Standard (Ref.: VE-714)</b>  <b>Ref.: VE-7141</b>	<b>14<sup>80</sup>€</b>

Válvulas **Clippard**<sup>®</sup>

*Clippard*

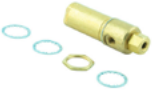
- Primera calidad.
- Acabados y tolerancias según normas DIN.
- **Garantía** 3 meses.









	Descripción	Observaciones
 <p><b>Ref.: VE-600</b></p>	<p>Válvula antigoteo Relay WDV-2</p>	<p><b>Conexiones:</b> 10/32" Agua (Ref Fedesa 770A04)</p> <p><b>49<sup>80</sup>€</b></p>
 <p><b>Ref.: VE-602</b></p>	<p>Válvula corte aire/agua <u>sin retracción</u></p>	<p><b>Conexiones:</b> 10/32" Aire y Agua</p> <p><b>56<sup>80</sup>€</b></p>
 <p><b>Ref.: VE-620</b></p>	<p>Mini válvula SMAV-3 control pértigas colibrí</p>	<p><b>Aire</b> (Ref Fedesa 770A01)</p> <p><b>53<sup>80</sup>€</b></p>

Válvulas **RUMAR**<sup>®</sup>

**RUMAR**

- Primera calidad.
- Acabados y tolerancias según normas DIN.
- **Garantía** 3 meses.









	Descripción	Observaciones
 <p><b>Ref.: VE-590</b></p>	<p>Válvula antigoteo</p>	<p><b>Conexiones:</b> 10/32" Agua <b>Incluye espigas de 10/32" x 1,6mm</b></p> <p><b>32<sup>80</sup>€</b></p>
 <p><b>Ref.: VE-740</b></p>	<p>Válvula neumática ON/OFF, 3 vías</p>	<p><b>Conexiones:</b> 10/32" Agua <b>Estado:</b> Normalmente cerrada</p> <p><b>30<sup>80</sup>€</b></p>
 <p><b>Ref.: 37-211</b></p>	<p>Válvula Hanger con puertos laterales</p>	<p><b>Estado:</b> Normalmente abierta</p> <p><b>15<sup>80</sup>€</b></p>
 <p><b>Ref.: VE-731</b></p>	<p>Válvula Hanger con puertos laterales</p>	<p><b>Estado:</b> Normalmente cerrada</p> <p><b>15<sup>80</sup>€</b></p>

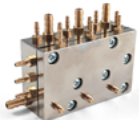
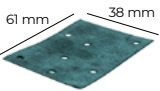





	Descripción	Observaciones
	<p>Válvula Hanger con puertos traseros</p> <p>Ref.: <b>VE-732</b></p>	<p>Estado: Normalmente abierta</p> <p>8´80€</p> <p>HASTA AGOTAR</p>
	<p>Válvula Hanger con puertos traseros</p> <p>Ref.: <b>VE-733</b></p>	<p>Estado: Normalmente cerrada</p> <p>8´80€</p> <p>HASTA AGOTAR</p>
	<p>Válvula ON/OFF con palanca gris, 2 vías, liberación rápida</p> <p>Ref.: <b>VE-735</b></p>	<p>Conexiones: 10/32" Aire o Agua</p> <p>15´80€</p>
	<p>Válvula cartucho selector con palanca gris, 3 vías, liberación rápida</p> <p>Ref.: <b>VE-737</b></p>	<p>Conexiones: 10/32" Aire o Agua</p> <p>32´80€</p>
	<p>Válvula de regulación de caudal</p> <p>Ref.: <b>VE-581</b></p>	<p>Conexiones: 10/32" (1 puerto lateral / 1 puerto inferior) Aire o Agua</p> <p>12´80€</p>
	<p>Miniregulador presión de agua</p> <p>Ref.: <b>VE-582</b></p>	<p>Conexiones: 10/32" Incluye espigas 1,6mm Agua</p> <p>24´80€</p>
	<p>Válvula doble para jeringas 3F</p> <p>Ref.: <b>VE-583</b></p>	<p>Conexiones: 10/32" NO incluye espigas</p> <p>12´80€</p>
	<p>Válvula control dirección con palanca, 3 vías</p> <p>Ref.: <b>VE-738</b></p>	<p>Conexiones: 10/32" Aire o Agua</p> <p>21´80€</p>

# VÁLVULAS, ELECTROVÁLVULAS Y OTROS PARA SILLONES FEDESA®

Válvulas, electroválvulas y otros para sillones Fedesa®

RUMAR

	Descripción		Observaciones
	<p>Grupo distribuidor 3 instrumentos equipos Fedesa®</p> <p>Ref.: <b>FED-317A04</b> (Ref. Fedesa®: 317A04)</p>	<p>98'00€*</p>	<p>Repuesto relacionado: VE-7031</p> <p>*Sin descuento</p>
 <p>61 mm 38 mm</p>	<p>Membrana bloque Fedesa® (Ref.: FED-317A04) 3 instrumentos</p> <p>Ref.: <b>FED-317A02</b> (Ref. Fedesa®: 317A02)</p>	<p>14'80€</p>	
	<p>Bloque 2 electroválvulas</p> <p>Ref.: <b>FED-054A05</b> (Ref. Fedesa®: 054A05)</p>	<p>80'00€*</p>	<p>Voltaje: 24 V AC 50 Hz Repuestos relacionados: FED-237A12 y FED-237A03</p> <p>*Sin descuento</p>
	<p>Bobina 5VA</p> <p>Ref.: <b>FED-237A14</b> (Ref. Fedesa®: 237A14)</p>	<p>12'80€*</p>	<p>Diámetro: 9 mm Voltaje: 24 V AC Repuesto para bloque Fedesa Ref.: 054A04</p> <p>*Sin descuento</p>
	<p>Bobina 7,5VA con núcleo</p> <p>Ref.: <b>FED-237A03</b> (Ref. Fedesa®: 237A03)</p>	<p>32'80€*</p>	<p>Voltaje: 24 V AC Repuesto para bloque Fedesa Ref.: 054A05</p> <p>*Sin descuento</p>
	<p>Núcleo + guía latón EV agua</p> <p>Ref.: <b>FED-237A12</b> (Ref. Fedesa®: 237A12)</p>	<p>18'80€*</p>	<p>Repuesto para bloque Fedesa Ref.: 054A05</p> <p>*Sin descuento</p>
	<p>Conjunto 24 V AC</p> <p>Ref.: <b>FED-054A04</b> (Ref. Fedesa®: 054A04)</p>	<p>23'80€*</p>	<p>Repuesto relacionado: FED-237A14</p> <p>*Sin descuento</p>
	<p>Placa conexión 28 con junta</p> <p>Ref.: <b>FED-185A65</b> (Ref. Fedesa®: 185A65)</p>	<p>28'80€*</p>	<p>*Sin descuento</p>
	<p>Membrana placa conexión Fedesa® (FED-185A65)</p> <p>Ref.: <b>FED-4101K03</b> (Ref. Fedesa®: 4101K03)</p>	<p>2'80€*</p>	<p>*Sin descuento</p>

	Descripción		Observaciones
	Filtro bronce  <b>Ref.: FED-275A09</b> (Ref. Fedesa®: 275A09)	 2'80€*	*Sin descuento
	Unión 6mm macho x 1/8" macho Especial Fedesa  <b>Ref.: FED-575A70</b> (Ref. Fedesa®: 575A70)	 0'80€*	*Sin descuento
	"T" Intermedias 6 x 6 x 6 mm Especial Fedesa  <b>Ref.: FED-575A55</b> (Ref. Fedesa®: 575A55)	 0'90€*	*Sin descuento





## ELECTROVÁLVULAS SIRAI® / ASCO NEUMATICS®







Electroválvulas Sirai® / Asco Neumatics® / Emerson®



ASCO®

- SIRAI® / ASCO® / EMERSON®
- Primera calidad.
- Acabados y tolerancias según normas DIN.
- Garantía 3 meses.

	Descripción		Observaciones
	Electroválvula escupidera 2 vías, normalmente cerrado Juntas Vitón <b>Aire o Agua</b>  <b>Ref.: VE-L172011</b>	53'80€	<b>Conexiones:</b> 2 x 1/8" <b>Voltage:</b> 24V+/-10% AC / CA, 50/60 Hz. <b>Potencia:</b> 3W <b>Tº Fluido:</b> de 0°C a 130 °C <b>Diámetro de paso:</b> 2,4mm <b>Presión de trabajo (Aire/agua):</b> 0-13 bar
	Electroválvula escupidera 2 vías, normalmente cerrado Juntas Vitón <b>Aire o Agua</b>  <b>Ref.: VE-L172012</b>	53'80€	<b>Conexiones:</b> 2 x 1/8" <b>Voltage:</b> 24V+/-10% DC / CC <b>Potencia:</b> 3,5W <b>Tº Fluido:</b> de 0°C a 130 °C <b>Diámetro de paso:</b> 2,4mm <b>Presión de trabajo (Aire/agua):</b> 0-4 bar
	Electroválvula colibrí / ultrasonidos 2 vías, V165V01, normalmente cerrado Juntas Vitón <b>Aire o Agua</b>  <b>Ref.: VE-V165012</b>	53'80€	<b>Conexiones:</b> 2 x M5 <b>Voltage:</b> 24V+/-10% DC / CC <b>Potencia:</b> 4W <b>Tº Fluido:</b> de 0°C a 130 °C <b>Diámetro de paso:</b> 2,0mm <b>Presión de trabajo (Aire/agua):</b> 0-4 bar <b>Presión máxima admisible:</b> 16 bar
	Electroválvula V124D03, normalmente cerrado Juntas EPDM <b>Aire y Agua</b>  <b>Ref.: VE-V124012</b>	61'80€	<b>Conexiones:</b> Especial <b>Voltage:</b> 24V+/-10% DC / CC <b>Potencia:</b> 4W <b>Tº Fluido:</b> de -10°C a 100 °C <b>Presión de trabajo (Aire/agua):</b> 0-6 bar <b>Presión máxima admisible:</b> 16 bar
	Electroválvula entrada 2 vías, normalmente cerrado Juntas Vitón <b>Aire, agua o vapor</b>  <b>Ref.: VE-L121012</b>	72'80€	<b>Conexiones:</b> 2 x 1/4" <b>Voltage:</b> 24V+/-10% DC / CC <b>Potencia:</b> 5W <b>Tº Fluido:</b> de 0°C a 130 °C <b>Diámetro de paso:</b> 4,5mm <b>Presión de trabajo (Aire/agua):</b> 0-3 bar

	Descripción	Observaciones
	Electrovalvula entrada 2 vías, normalmente cerrado Juntas Vitón <b>Aire, agua o vapor</b>	<b>Conexiones:</b> 2 x 1/4" <b>Voltage:</b> 230V+/-10% AC / CA 50Hz. <b>Potencia:</b> 9W <b>Tº Fluido:</b> de 0°C a 130 °C <b>Diámetro de paso:</b> 4,5mm <b>Presión de trabajo (Aire/agua):</b> 0-8 bar
	Electrovalvula entrada, 3 vías, universal Juntas Vitón <b>Aire, agua o vapor</b>	<b>Conexiones:</b> 2 x 1/4" + 1 x 1/8" <b>Voltage:</b> 24V+/-10% DC / CC <b>Potencia:</b> 9W <b>Tº Fluido:</b> de 0°C a 130 °C <b>Diámetro de paso:</b> 2,3mm <b>Presión de trabajo (Aire/agua):</b> 0-5 bar
	Electrovalvula V162B02, normalmente cerrado Juntas Nitrilo <b>Aire o Agua</b>	<b>Conexiones:</b> 2 x M5 <b>Voltage:</b> 24V+/-10% DC / CC <b>Potencia:</b> 4W <b>Tº Fluido:</b> de 0°C a 90 °C <b>Diámetro de paso:</b> 2,4mm <b>Presión de trabajo (Aire/agua):</b> 0-2 bar <b>Presión máxima admisible:</b> 16 bar
	Electrovalvula 2 vías V164B02, proporcional, normalmente cerrado Juntas Nitrilo <b>Aire o Agua</b> Antigua V164B05	<b>Conexiones:</b> 2 x M5 <b>Voltage:</b> 12-24V+/-10% DC / CC <b>Potencia:</b> 4W <b>Tº Fluido:</b> de -10°C a 90 °C <b>Diámetro de paso:</b> 1,6 mm <b>Presión de trabajo (Aire/agua):</b> 0-5 bar <b>Presión máxima admisible:</b> 16 bar
	Electrovalvula 2 vías, L194D01, normalmente cerrado, proporcional Juntas Vitón <b>Aire o Agua</b> <b>Usada en sillones Cefla entre otros (hay que aprovechar los conectores del anterior)</b>	<b>Conexiones:</b> 1 x 1,8" + 1 x 1,6mm <b>Voltage:</b> 24V+/-10% DC / CC <b>Potencia:</b> 5,5W <b>Tº Fluido:</b> de 0°C a 130 °C <b>Diámetro de paso:</b> 1,6mm <b>Presión de trabajo (Aire/agua):</b> 0-6 bar <b>Presión máxima admisible:</b> 50 bar
	Grupo 3 microactuariales, V625D01, normalmente cerrado Juntas EPDM <b>Aire o Agua</b> <b>Usada en sillones Vitali entre otros</b>	<b>Conexiones:</b> 3 x 1,6mm <b>Voltage:</b> 12-24V+/-10% DC / CC <b>Potencia:</b> 4W <b>Tº Fluido:</b> de -10°C a 90 °C <b>Diámetro de paso:</b> 1,6mm <b>Presión de trabajo (Aire/agua):</b> 0-6 bar <b>Presión máxima admisible:</b> 8 bar
	Kit reparación para válvula ASCO V625D1	<b>Incluye:</b> Cabezal alimentación, cabezal lateral final, tornillo, anillo tórico y pin.
	<b>Ref.: VE-G3144801</b>	<b>50<sup>80</sup>€</b>

## VÁLVULAS ELECTRONEUMÁTICAS

Válvulas electroneumáticas RUMAR®

RUMAR

- Primera calidad.
- Acabados y tolerancias según normas DIN.
- Garantía 3 meses.

Descripción	Observaciones
 <p>Micro electroneumático</p> <p><b>Ref.: VE-580</b></p>	<p><b>Conexiones:</b> 10/32"</p> <p><b>Info Técnica:</b> 15A, 1/2 HP 125-250V AC / CA 50Hz. 0,6A 125V DC / CC 0,3A 250V DC / CC</p> <p><b>Estado:</b> Normalmente cerrada</p> <p><b>Incluye:</b> espiga de 10/32" x 4,6mm</p> <p><b>23<sup>80</sup>€</b></p>

SI NO ENCUENTRAS EL REPUESTO QUE BUSCAS, ¡CONSÚLTANOS!  
Precios: impuestos, portes y mano de obra no incluidos.

RPD









## ▶ **REGULADORES DE PRESIÓN Y REPUESTOS DEPÓSITOS DE AGUA DESTILADA**

- Reguladores y accesorios
- Repuestos depósito agua destilada

# REGULADORES Y ACCESORIOS

## Reguladores de presión

RUMAR



	Descripción	Observaciones
	Regulador de presión de aire con tuerca y manómetro <b>Presiones:</b> 0 - 8 bar (15 bar máx.) <b>Conexiones:</b> 1/8" hembra / hembra <b>Caudal:</b> 600 NI/min  <b>Ref.: 54-263</b> (Ref. Fedesa®: 2110D + 415A07)	<b>Manómetro</b> de 40mm  Para (Ref. Fedesa® 2108D añadir racores en sección Racorería)
	Regulador de presión de aire con filtro de agua y manómetro <b>Presiones:</b> 0 - 8 bar (15 bar máx.) <b>Conexiones:</b> 1/8" hembra / hembra <b>Caudal:</b> 600 NI/min  <b>Ref.: 54-261</b>	<b>Manómetro</b> de 40mm
	Regulador de presión de agua con tuerca y manómetro <b>Presiones:</b> 0 - 8 bar (15 bar máx.) <b>Conexiones:</b> 1/8" hembra / hembra  <b>Ref.: 54-264</b> (Ref. Fedesa®: 2112D + 415A07)	<b>Manómetro</b> de 40mm  (Ref. Fedesa® 2109D*) *Racorería ver sección Racorería
	Manómetro de 40mm <b>Presiones:</b> 0 - 12 bar <b>Conexiones:</b> 1/8" MTG  <b>Ref.: 54-272</b>	
	Filtro aire completo <b>Presiones:</b> 15 bar máx. <b>Conexiones:</b> 1/8" hembra / hembra <b>Caudal:</b> 800 NI/min  <b>Ref.: 54-265</b>	<b>Filtración:</b> 20 µm  (Ref. Fedesa® 275A08)
	Kit unión reguladores / filtros  <b>Ref.: 54-266</b>	<b>Compatible:</b> 54-263, 54-264, 54-265
	Filtro aire completo <b>Presiones:</b> 7 bar máx. <b>Conexiones:</b> 1/8" hembra / hembra  <b>Ref.: 54-604800</b> (Ref. Faro®: 224800)	<b>Compatible con unión:</b> 54-604803
	Regulador presión de aire <b>Presiones:</b> 0 - 6 bar (10 bar máx.) <b>Conexiones:</b> 1/8" hembra / hembra <b>Caudal:</b> 250 l/min  <b>Ref.: 54-604801</b> (Ref. Faro®: 224801)	<b>Compatible con unión:</b> 54-604803
	Manómetro de 25mm <b>Presiones:</b> 0 - 12 bar <b>Conexiones:</b> 1/8" MTG  <b>Ref.: 54-604802</b> (Ref. Faro®: 224802)	

HASTA AGOTAR

	Filtro agua completo <b>Presiones:</b> 7 bar máx <b>Conexiones:</b> 1/8" hembra/hembra	Compatible con unión: 54-604803
	<b>Ref.: 54-604805</b> (Ref. Faro®: 224805)	40 <sup>80</sup> €
	Regulador de presión de agua <b>Presiones:</b> 0 - 6 bar (10 bar máx.) <b>Conexiones:</b> 1/8" hembra / hembra	Compatible con unión: 54-604803
	<b>Ref.: 54-604806</b> (Ref. Faro®: 224806)	50 <sup>80</sup> €
	Unión reguladores / filtros	Compatible: 54-604800, 54-604801, 54-604805 y 54-604806
	<b>Ref.: 54-604803</b> (Ref. Faro®: 224803)	3 <sup>00</sup> €

### Accesorios reguladores de presión

RUMAR



	Descripción	Observaciones
	Escuadra-soporte regulador <b>Ref.: 54-270</b>	Para referencias: 54-263 y 54-261 2 <sup>90</sup> €
	Tuerca regulador <b>Ref.: 54-271</b>	Para referencias: 54-263 y 54-261 4 <sup>00</sup> €

HASTA AGOTAR









## REPUESTOS DEPÓSITOS DE AGUA DESTILADA

### Repuestos depósitos de agua destilada

RUMAR

	Descripción	Observaciones
	Conector rápido entrada <b>Ref.: 52-205</b>	Color: Gris Sin adaptador 16 <sup>80</sup> €
	Conector rápido salida <b>Ref.: 52-206</b>	Color: Negro Sin adaptador 16 <sup>80</sup> €

SÓLO ASEGUAMOS COMPATIBILIDAD CON LOS TANQUES DE AGUA DESTILADA DE RUMAR®

	Descripción	Observaciones
	Anillos tóricos conectores  <b>Ref.: 52-213</b>	<b>0'90€</b>
	Conector entrada  <b>Ref.: 52-214</b>	<b>14'80€</b>
	Conector salida  <b>Ref.: 52-215</b>	<b>14'80€</b>
	Tubo interno líquido  <b>Ref.: 52-216</b>	<b>8'00€</b>
	Adaptador / conector  <b>Ref.: 52-207</b>	<b>5'80€</b>  Color: Negro Diametro: 6mm
	Tapa + Válvula de desahogo + Junta  <b>Ref.: 52-210</b>	<b>32'80€</b>
	Junta tapa  <b>Ref.: 52-211</b>	<b>4'80€</b>
	Válvula de desahogo  <b>Ref.: 52-212</b>	<b>7'80€</b>

SÓLO ASEGURAMOS COMPATIBILIDAD CON LOS TANQUES DE AGUA DESTILADA DE RUMAR®

SI NO ENCUENTRAS EL REPUESTO QUE BUSCAS, ¡CONSÚLTANOS!  
 Precios: impuestos, portes y mano de obra no incluidos.

H







## ▶ HERRAMIENTAS



- Herramientas instrumental rotatorio
- Herramientas equipos











# Llaves Tapa / Botón Turbinas

Llaves Tapa / Botón Turbinas KaVo®



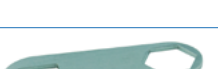

RUMAR

	Descripción	Observaciones
	<p><b>Lado A (4 muescas):</b>                      COMPACTtorque® 636                      GENTLEforce® 6000                      GENTLEforce® 7000                      GENTLEsilence® 8000</p> <p>MASTERtorque® M9000                      MASTERtorque® M9000L                      SMARTtorque® 609                      SMARTtorque® 619</p> <p>SUPERtorque® 650                      SUPERtorque® 655                      SUPERtorque® 660</p> <p><b>Lado B y Lado C ver sección llaves MK-dent®</b></p> <p><b>Ref.: HE-620</b></p>	<p>Llave triple</p> <p><b>29<sup>80</sup>€</b></p>
	<p>SMARTtorque® 609                      SMARTtorque® 619                      COMPACTtorque® 636                      SUPERtorque® 650</p> <p>SUPERtorque® 655                      SUPERtorque® 660                      GENTLEforce® 6000                      GENTLEforce® 7000</p> <p>GENTLEsilence® 8000                      MASTERtorque® M9000                      MASTERtorque® M9000L</p> <p><b>Ref.: HE-1650T</b></p>	<p><b>43<sup>80</sup>€</b></p>
	<p><b>Lado A (4 puntos):</b>                      SMARTtorque® 609                      SMARTtorque® 619                      COMPACTtorque® 636                      SUPERtorque® 650                      SUPERtorque® 655</p> <p>SUPERtorque® 660                      EXPERTtorque® E680                      EXPERTtorque® E679                      GENTLEforce® 6000</p> <p>GENTLEforce® 7000                      GENTLEsilence® 8000                      MASTERtorque® M9000                      MASTERtorque® M8700</p> <p><b>Lado B (3 puntos):</b> (Ref.: KaVo® 1.008.6133)                      SMARTtorque Mini® S605                      SMARTtorque Lux® S615                      EXPERTtorque Mini® E677</p> <p>EXPERTtorque Mini Lux® E675                      GENTLEforce® 4500                      GENTLEforce® 5000</p> <p><b>Ref.: HE-604</b></p>	<p>Llave doble</p> <p><b>23<sup>80</sup>€</b></p>
	<p>SUPERtorque® 630                      BELLAtorque® 639                      BELLAtorque® 642</p> <p>BELLAtorque® 645                      SUPERtorque® 640</p> <p><b>Ref.: HE-609</b></p>	<p><b>34<sup>80</sup>€</b></p>
	<p>MIRAlux® 635                      MIRAtorque mini® 637</p> <p><b>Ref.: HE-1637T</b></p>	<p><b>43<sup>80</sup>€</b></p>
	<p>Punta para llave HE-751 para tapa turbinas</p> <p>SMARTtorque® 609                      SMARTtorque® 619                      COMPACTtorque® 636                      SUPERtorque® 650</p> <p>SUPERtorque® 655                      SUPERtorque® 660                      GENTLEforce® 6000                      GENTLEforce® 7000</p> <p>GENTLEsilence® 8000                      MASTERtorque® M9000                      MASTERtorque® M9000L</p> <p><b>Ref.: HE-756</b></p>	<p><b>13<sup>80</sup>€</b></p>
	<p>Punta para llave HE-751 para tapa turbinas</p> <p><b>Lado B (3 puntos):</b>                      SMARTtorque Mini® S605                      SMARTtorque Lux® S615                      EXPERTtorque Mini® E677</p> <p>EXPERTtorque Mini Lux® E675                      GENTLEforce® 4500                      GENTLEforce® 5000</p> <p><b>Ref.: HE-755</b></p>	<p><b>13<sup>80</sup>€</b></p>





	Descripción	Observaciones
	<p><b>Lado A (4 muescas):</b>                      HE12 HC4021                      HE15 HC5021                      HE17 (HE010000&lt;N/S&lt;HE023799) HC6021 (A partir Serie F)                      HE21 HC7021</p> <p><b>Lado B (4 lados):</b>                      HE14 HC4012 HC6022                      HE18 HC4022 HC7022                      HE22 HC5022 HC8022                      HP22 HC6012 HC9022</p> <p><b>Lado C (4 lados):</b>                      HC2012 (Desde Serie F)                      HC4011</p> <p><b>Ref.: HE-620</b></p>	<p>Llave triple</p> <p><b>29<sup>80</sup>€</b></p>
	<p>HP21 (N/S&lt;05) HC8021 HE15 HE15L                      HC21 HC9021 HB12                      HE21 (N/S&lt;05) HE17 (HE010000&lt;N/S&lt;HE023799) HE11 HE12</p> <p><b>Ref.: HE-1650T</b></p>	<p>Utilizable con llave HE-751 y llaves dinamométrica HE-2025 y HE-2026.</p> <p><b>*Comprobar que tapa tiene 4 muescas de contacto*</b></p> <p><b>33<sup>80</sup>€</b></p>
	<p>HC20 HE17 (N/S&gt;HE023800)                      HP21 (N/S&gt;05)                      HC21 (N/S&gt;05)</p> <p><b>Ref.: HE-1651T</b></p>	<p>Utilizable con llave HE-751 y llaves dinamométrica HE-2025 y HE-2026.</p> <p><b>*Comprobar que tapa tiene 4 lados de contacto*</b></p> <p><b>43<sup>80</sup>€</b></p>





	Descripción	Observaciones
	Cabezas mini (Excepto Alegra®TE-97 / Alegra®TE-98)  <b>Ref.: HE-1096W</b>	2 muescas  29'80€
	Synea® TA-98  <b>Ref.: HE-840</b>	2 muescas  39'80€
	<b>Lado A (3 muescas):</b> Synea® TA-97 Alegra®TE-97  <b>Ref.: HE-602</b>	<b>Lado B (3 muescas):</b> Synea® TA-98 LED Synea Fusion® TG-98  Llave doble  23'80€
	Alegra® TE-98 Alegra® TE-95 Trend® TC80BC Trend® TC-95BC  <b>Ref.: HE-606</b>	Trend 398 Trend 698 Trend 795  Trend 798 Trend 895 Trend 898  2 muescas  39'80€
 <p>Imagen no disponible</p>	196 796 896  <b>Ref.: HE-836</b>	2 muescas  39'80€  <span style="background-color: green; color: white; padding: 2px;">BAJO PEDIDO</span>
	RC-95RM  <b>Ref.: HE-929</b>	Incorpora saca golpes en parte delantera  28'00€
	<b>Lado A (Hexagonal):</b> Alegra® HS2014 TE97  <b>Ref.: HE-610</b>	<b>Lado B (cuadrada):</b>  Ver sección NSK® para otros modelos Ver sección Sirona® para otros modelos  Llave doble  39'80€
	<b>Lado A (Hexagonal):</b> Alegra® HS2014 TE95 Alegra® HS2014 TE98  <b>Ref.: HE-829</b>	<b>Lado B (Hexagonal):</b> Alegra® HS2014 TE97  Llave doble  23'80€
	Synea® Vision TK-100 Synea® Vision TK-94  <b>Ref.: HE-619</b>	3 Muecas  23'80€

Llaves Tapa / Botón Turbinas **Bien Air®**





	Descripción	Observaciones
	<p><b>Lado A (2 puntos):</b> Tapa Interna / Bisel Bora* Tapa Interna / Bisel Croma Tapa Interna / Bisel Boralina <b>*Excepto Bora 2</b></p> <p><b>Lado B (2 puntos):</b> Tapa externa Bora* Tapa externa Croma Tapa externa Boralina</p> <p><b>Ref.: HE-802</b> (Ref. Bien Air®: 3600072)</p>	<p>Llave doble</p> <p><b>39<sup>80</sup>€</b></p>
	<p>Bora 2</p> <p><b>Ref.: HE-618</b> (Ref. Bien Air®: 3600150)</p>	<p><b>39<sup>80</sup>€</b></p>
	<p><b>Lado A:</b> Interna y externa Prestige</p> <p><b>Lado B:</b> Externa Ondine</p> <p><b>Ref.: HE-803</b> (Ref. Bien Air®: 3600071)</p>	<p>Llave doble</p> <p><b>39<sup>80</sup>€</b></p>
	<p>Tornado (N/S&lt;16E0001)</p> <p><b>Ref.: HE-831</b></p>	<p><b>39<sup>80</sup>€</b></p>
	<p>Tornado S (cabeza mini)</p> <p><b>Ref.: HE-846</b> (Ref. Bien Air®: 4602179)</p>	<p><b>39<sup>80</sup>€</b></p>







Llaves Tapa / Botón Turbinas **Sirona®**

	Descripción	Observaciones
	<p>T1 Control Racer T2 Control Mini T3 Control Siroboost</p> <p><b>Ref.: HE-591</b></p>	<p>Llave triple 2 muescas</p> <p><b>12<sup>80</sup>€</b></p>
	<p><b>Lado A: (3 muescas)</b> T1 Control</p> <p><b>Lado B: (3 muescas)</b> Mini</p> <p><b>Ref.: HE-592</b></p>	<p>Llave doble</p> <p><b>14<sup>80</sup>€</b></p>
	<p>T1 Boost (N/S&gt;600.000 y N/S&gt;700.000) T2 Boost (N/S&gt;600.000 y N/S&gt;700.000) T3 Boost (N/S&gt;600.000 y N/S&gt;700.000)</p> <p><b>Ref.: HE-612</b> (Ref. Sirona®: 6449144)</p>	<p>3 muescas</p> <p><b>48<sup>00</sup>€</b></p>
	<p>T1 Boost (N/S&gt;800.000) T2 Boost (N/S&gt;800.000) T3 Boost (N/S&gt;800.000)</p> <p><b>Ref.: HE-617</b></p>	<p>3 muescas</p> <p><b>39<sup>80</sup>€</b></p>

	Descripción	Observaciones
	T1 Control (N/S>600.000 y N/S>700.000) T2 Control (N/S>600.000 y N/S>700.000)  <b>Ref.: HE-633</b> (Ref. Sirona®: 6449180)	3 muescas  39'80€
 <p>Imagen no disponible</p>	T1 mini (N/S>600.000 y N/S>700.000) T2 mini (N/S>600.000 y N/S>700.000) T3 mini (N/S>600.000 y N/S>700.000)  <b>Ref.: HE-634</b> (Ref. Sirona®: 6449172)	3 muescas  39'80€ <span style="float: right; background-color: green; color: white; padding: 2px;">BAJO PEDIDO</span>
 <p>Imagen no disponible</p>	T1 mini (N/S>800.000) T2 mini (N/S>800.000) T3 mini (N/S>800.000)  <b>Ref.: HE-635</b> (Ref. Sirona®: 6698687)	3 muescas  39'80€ <span style="float: right; background-color: green; color: white; padding: 2px;">BAJO PEDIDO</span>
	T1 Control (N/S>800.000) T2 Control (N/S>800.000)  <b>Ref.: HE-636</b> (Ref. Sirona®: 6698596)	3 muescas  39'80€



▶ Llaves Tapa / Botón Turbinas **Castellini®**

	Descripción	Observaciones
	Hi Power M Clean Air  Titanium Power Clean Light  <b>Ref.: HE-800</b>	Llave para tapas originales. (2 orificios) Para tapas compatibles. (Ref.: TT-0801) Ver Ref.: HE-824  35'80€
	Silent Power Gold Silent Power Gold M Hi Power Light  <b>Ref.: HE-810</b>	35'80€
	Silent Power <b>EVO</b> 2 Silent Power <b>EVO</b> 2L Silent Power <b>EVO</b> 4L Silent Power <b>EVO</b> 4LK  <b>Ref.: HE-822</b>	34'80€
	Silent Power EVO Miniature Silent Power EVO Miniature K  <b>Ref.: HE-823</b>	34'80€
	Silent Power <b>Silver</b> 2 Silent Power <b>Silver</b> 2L Silent Power <b>Silver</b> 4L Silent Power <b>Silver</b> 4LK  <b>Ref.: HE-824</b>	Válida también para tapa compatible TT-0801. (4 puntos de contacto)  34'80€

	Descripción	Lado B (10,00mm octogonal): Pana Air Rainbow	Observaciones	
	<b>Lado A (11,30mm octogonal):</b> Ti-Max X500* Ti-Max X500*L NL9000M Pana Max TUM4		Llave doble *: K, S, W, B	
Ref.: <b>HE-008</b>	12´40.€	HASTA AGOTAR		
	Ti-Max NL95M Ti-Max A500*L Ti-Max A500*	Pana Air	Medidas: 9,60 mm octogonal *: K, S, W, B	
Ref.: <b>HE-107</b>	12´40.€			
	<b>Lado A (12,30 mm hexagonal)</b> Rainbow Nuevo modelo	<b>Lado B (10,90 mm hexagonal)</b>	Llave doble	
Ref.: <b>HE-009</b>	14´80.€	HASTA AGOTAR		
	<b>Lado A (Octogonal):</b> S-Max M600* S-Max M600*L	<b>Lado B (Octogonal):</b> Pico	Llave doble *: K, S, W, B	
Ref.: <b>HE-632</b>	18´80.€			
	<b>Lado A (10,60 mm octogonal):</b> Ti-Max NL 45S Ti-Max NL 45T Ti-Max NL 95T Ti-Max NL95 S Ti-Max A600* Ti-Max A600*L Ti-Max A300* Ti-Max A300*L Ti-Max A450* Ti-Max A450*L	Ti-Max A700* Ti-Max A700*L Phatelus 45 S Phatelus 45 SU Phatelus II S Phatelus II SU Ti-Max NL75 Mach Light S NL85 Mach Light NL65S Mach Light Mach Lite XT S Mach Lite XT SU	<b>Lado B (10,95 mm octogonal):</b> Ti-Max X600* Ti-Max X600*L Ti-Max NL9000*S Pana-Max 2	Llave doble *: K, S, W, B
Ref.: <b>HE-600</b>	23´80.€			
	<b>Lado A (12,90mm octogonal):</b> Ti-Max X700*L Ti-Max X700* Ti-Max NL9000*T	<b>Lado B (11,30mm octogonal):</b> Ti-Max X500*L Ti-Max X500* Ti-Max NL9000M	<b>Lado C (10,95 mm octogonal):</b> Ti-Max X600* Ti-Max X600*L Ti-Max NL9000*S	Llave triple *: K, S, W, B
Ref.: <b>HE-605</b>	23´80.€			
	<b>Lado A (3 muescas):</b> Ti-Max Z800	<b>Lado B (3 muescas):</b> Ti-Max Z900	Llave doble	
Ref.: <b>HE-614</b>	23´80.€			



Llaves Tapa-Botón Turbinas Morita®

RUMAR

	Descripción	Observaciones
	TwinPower PAR-4HEX-O  <b>Ref.: HE-637</b>	39'80€
	TwinPower PAR-4HX-O  <b>Ref.: HE-638</b>	39'80€

Llaves Tapa-Botón Turbinas Chirana®

RUMAR

	Descripción	Observaciones
 	TG-656 TG-637A (smile - music)  <b>Ref.: HE-609</b>	34'80€



Llaves Multiusos

RUMAR

	Descripción	Observaciones
	Lado A (9,60 mm hexagonal) Lado B (8,10mm cuadrada) Lado C (10,20 mm cuadrada) Lado D (4 puntos)  <b>Ref.: HE-603</b>	12'40€

Llaves Tapa / Botón Turbinas RUMAR®



RUMAR

	Descripción	Observaciones
	ECO T2 ECO T3 L PRO TIL  <b>Ref.: HE-252K</b>	4'80€
	ECO T TURBO  <b>Ref.: HE-253K</b>	4'80€

## LLAVES TAPAS DE SPRAY TURBINAS

### ▶ Llaves tapas de spray turbinas **KaVo®**

RUMAR

	Descripción	Observaciones
	<p>SUPERtorque® 630 SUPERtorque® 640 BELLAtorque® 645</p> <p>SUPERtorque® 647B SUPERtorque® 655 SUPERtorque® 660</p> <p>Ref.: <b>HE-1022KT</b></p>	<p>Utilizable con llave HE-751 y llaves dinámicas HE-2025 y HE-2026</p> <p><b>43'80€</b></p>
	<p>SUPERtorque® 630 SUPERtorque® 640 BELLAtorque® 645</p> <p>SUPERtorque® 647B SUPERtorque® 650</p> <p>SUPERtorque® 655 SUPERtorque® 660</p> <p>Ref.: <b>HE-621</b></p>	<p><b>14'80€</b></p>



### ▶ Llaves tapas de spray turbinas **RUMAR®**

RUMAR

	Descripción	Observaciones
	<p>PowerMax</p> <p>Ref.: <b>HE-629</b></p>	<p><b>19'60€</b></p>

### ▶ Llaves tapas de spray turbinas **MK-dent®**









RUMAR

	Descripción	Observaciones
	<p>Todos los modelos con 3-Spray hasta N/S: G</p> <p>Ref.: <b>HE-1022KT</b></p>	<p>Utilizable con llave HE-751 y llaves dinámicas HE-2025 y HE-2026</p> <p><b>43'80€</b></p>
	<p>HC17 HC20 HC21</p> <p>HC8021 HC9021</p> <p>HE21 HP21</p> <p>Ref.: <b>HE-1922</b></p>	<p><b>27'80€</b></p>

# SACA GOLPES CABEZAS

Saca golpes cabezas

RUMAR







	Descripción	Observaciones
	<p><b>Bien Air® Bora</b></p> <p>Ref.: <b>HE-920</b> <span style="float: right;"><b>28´00€</b></span></p>	
	<p><b>Bien Air® Black Pearl</b></p> <p>Ref.: <b>HE-926</b> <span style="float: right;"><b>28´00€</b></span></p>	
	<p><b>NSK® Ti-Max X600</b></p> <p>Ref.: <b>HE-921</b> <span style="float: right;"><b>28´00€</b></span></p>	<p>Incorpora llave tapa en parte trasera</p>
	<p><b>NSK® S-Max M600</b></p> <p>Ref.: <b>HE-927</b> <span style="float: right;"><b>28´00€</b></span></p>	<p>Incorpora llave tapa en parte trasera</p>
	<p><b>NSK® Ti-Max Z900</b></p> <p>Ref.: <b>HE-928</b> <span style="float: right;"><b>28´00€</b></span></p>	<p>Incorpora llave tapa en parte trasera</p>
	<p><b>KaVo® BELLAtorque® 642</b></p> <p>Ref.: <b>HE-922</b> <span style="float: right;"><b>28´00€</b></span></p>	<p>Incorpora llave tapa en parte trasera</p>
	<p> <b>KaVo® SUPERtorque® 655</b>  <b>KaVo® SUPERtorque® 650</b>  <b>KaVo® SUPERtorque® 660</b> </p> <p> <b>KaVo® GENTLEforce® 7000</b>  <b>KaVo® GENTLEforce® 8000</b> </p> <p>Ref.: <b>HE-925</b> <span style="float: right;"><b>28´00€</b></span></p>	
	<p><b>W&amp;H® RC-95RM</b></p> <p>Ref.: <b>HE-929</b> <span style="float: right;"><b>28´00€</b></span></p>	<p>Incorpora llave tapa en parte trasera</p>
	<p><b>W&amp;H® Synea® TA-98 LED</b></p> <p>Ref.: <b>HE-923</b> <span style="float: right;"><b>28´00€</b></span></p>	<p>Incorpora llave tapa en parte trasera</p>







	Descripción	Observaciones
	<p><b>W&amp;H® Synea® TA-98</b></p> <p>Ref.: <b>HE-924</b></p>	<p><b>28<sup>00</sup>€</b></p>

## LLAVES PARA CONTRA-ÁNGULOS y PIEZAS DE MANO









► Llaves para contra-ángulos y piezas de mano **KaVo®**

RUMAR



	Descripción	Observaciones
	<p>INTRAmatic® 25LH INTRAmatic® 25LHS INTRAmatic® 25CN INTRAmatic® 25CH</p> <p>Ref.: <b>HE-817</b></p>	<p>INTRAmatic® 25LS INTRAmatic® LUX 24LN INTRAmatic® LUX 24LS</p> <p><b>34<sup>80</sup>€</b></p>
	<p>EXPERTmatic® E25 EXPERTmatic® E25L</p> <p>Ref.: <b>HE-819</b> (Ref. Kavov®: 1.008.2377)</p>	<p><b>23<sup>80</sup>€</b></p>
	<p><b>Lado A (2 lados rectos):</b> INTRAlux® 67LDN INTRAlux® 68LDN</p> <p><b>Lado B (3 puntos):</b> INTRAlux® L67 INTRAlux® L68 INTRAlux® 67LH INTRAlux® 68LH</p> <p>Ref.: <b>HE-751</b></p>	<p>EXPERTmatic® E20L INTRAcompact® 2068LHC INTRAcompact® 2068CHC</p> <p><b>Llave doble</b></p> <p><b>49<sup>80</sup>€</b></p>
	<p><b>Punta para llave HE-751 para tapa cabezas:</b> INTRAlux® 67LDN INTRAlux® 68LDN</p> <p>Ref.: <b>HE-753LDN</b></p>	<p><b>2 lados rectos</b></p> <p>Utilizable con llave HE-751 y llaves dinamométricas HE-2025 y HE-2026</p> <p><b>13<sup>80</sup>€</b></p>
	<p><b>Punta para llave HE-751 para tapa cabezas:</b> INTRAlux® L67 INTRAlux® L68 INTRAlux® 67LH</p> <p>Ref.: <b>HE-753LH</b></p>	<p>INTRAlux® 68LH EXPERTmatic® E20L INTRAcompact® 2068LHC INTRAcompact® 2068CHC</p> <p><b>3 puntos</b></p> <p>Utilizable con llave HE-751 y llaves dinamométricas HE-2025 y HE-2026</p> <p><b>13<sup>80</sup>€</b></p>
	<p><b>Punta para llave HE-751 para tornillo:</b> 0.201.0005 Cabezas KaVo® SP2021 Cabezas MK-dent®</p> <p>Ref.: <b>HE-753TOR</b></p>	<p><b>Hexagonal miniatura</b></p> <p>Utilizable con llave HE-751 y llaves dinamométricas HE-2025 y HE-2026</p> <p><b>11<sup>80</sup>€</b></p>
	<p>INTRAlux® CL3</p> <p>Ref.: <b>HE-832</b> (Ref. Kavov®: 0.411.2371)</p>	<p><b>39<sup>80</sup>€</b></p>

	Descripción	Observaciones
	<p><b>Lado A (8 puntos):</b> MASTERmatic® LUX M05L</p> <p><b>Lado B (12 puntos):</b> Tapa compatible BVT-448</p> <p><b>Ref.: HE-850</b> (Ref. KaVo®: 3.001.3143)</p>	<p><b>59<sup>80</sup>€</b></p>
	<p>Mandril de montaje anillo de conducción 0.540.4072 Cabezas KaVo®</p> <p><b>Ref.: HE-752</b></p>	<p><b>19<sup>80</sup>€</b></p>
 <p><b>Wera</b></p>	<p>Destornillador hexagonal miniatura Wera para tornillo 0.201.0005. Cabezas KaVo®</p> <p><b>Ref.: HE-2016</b></p>	<p><b>21<sup>80</sup>€</b></p>
 <p><b>Wera</b></p>	<p>Destornillador miniatura Wera® plano</p> <p><b>Ref.: HE-2027</b></p>	<p><b>Medidas:</b> 0,25x1,2x40 mm</p> <p><b>19<sup>80</sup>€</b></p>
 <p><b>Wera</b></p>	<p>Destornillador miniatura Wera® plano</p> <p><b>Ref.: HE-2028</b></p>	<p><b>Medidas:</b> 0,23x1,5x40 mm</p> <p><b>19<sup>80</sup>€</b></p>
	<p>Llave anillo de cierre trasero contra ángulos y piezas de mano KaVo®</p> <p><b>Ref.: HE-2011BT</b> (Ref. KaVo®: 0.411.1881)</p>	<p><b>39<sup>80</sup>€</b></p>
	<p>Extractor especial desmontaje componentes interiores contra ángulos y piezas de mano KaVo®</p> <p><b>Ref.: HE-2015</b> (Ref. KaVo®: 0.411.4451)</p>	<p><b>69<sup>80</sup>€</b></p>
	<p>Extractor pieza frontal contra ángulos KaVo®</p> <p><b>Ref.: HE-2012</b> (Ref. KaVo®: 0.411.2381)</p>	<p><b>101<sup>80</sup>€</b></p>



Llaves para contra-ángulos y piezas de mano **MK-dent®**

	Descripción	Observaciones
	<p>Llave tapa cabezas contra ángulos LCH11 LS9011 LCH21 LS9021 LPH11 LS9111 LPH21 LS9121</p> <p><b>Ref.: HE-2011T</b></p>	<p><b>48<sup>00</sup>€</b></p>
	<p><b>Lado B (4 lados):</b> Llave tapa cabezas contra ángulos LS9016.</p> <p><b>Lado A y lado C, otras compatibilidades.</b> <b>Lado B</b> ver <b>sección llaves tapas turbina KaVo® y MK-dent®.</b></p> <p><b>Ref.: HE-620</b></p>	<p>Llave triple</p> <p><b>29<sup>80</sup>€</b></p>
	<p>Mandril de montaje anillo de conducción SP2007. Cabezas MK-dent®</p> <p><b>Ref.: HE-752</b></p>	<p><b>38<sup>80</sup>€</b></p>
 <p></p>	<p>Destornillador hexagonal miniatura Wera® para tornillo SP2021. Cabezas MK-dent®</p> <p><b>Ref.: HE-2016</b></p>	<p><b>21<sup>80</sup>€</b></p>
 <p></p>	<p>Destornillador miniatura Wera® plano</p> <p><b>Ref.: HE-2027</b></p>	<p>Medidas: 0,25x1,2x40 mm</p> <p><b>19<sup>80</sup>€</b></p>
 <p></p>	<p>Destornillador miniatura Wera® plano</p> <p><b>Ref.: HE-2028</b></p>	<p>Medidas: 0,23x1,5x40 mm</p> <p><b>19<sup>80</sup>€</b></p>

Llaves para contra-ángulos y piezas de mano **W&H®**







	Descripción	Observaciones
 <p>Imagen no disponible</p>	<p>Llave Tapa cabeza contra ángulos:</p> <p>Alegra® WE-56 (Rotor CON anillo azul)      Alegra® WE-56LED                      Alegra® WE-56A (Rotor CON anillo azul)      Alegra® WE-99A                      Alegra® WE-56E (Rotor CON anillo azul)      Alegra® WE-99 LED G                      Alegra® WE-56 (Rotor SIN anillo azul)      Fusion® WG-99LT (N/S&lt;007801)                      Alegra® WE-56T (Rotor SIN anillo azul)      Fusion® WG-99 LED G (N/S&lt;007801)</p> <p><b>Ref.: HE-763</b> (Ref. W&amp;H®: C-1077)</p>	<p><b>39<sup>80</sup>€</b></p>
	<p>Llave Eje cabeza contra ángulos:</p> <p>Alegra® WE-56 (Rotor CON anillo azul)      Alegra® WE-56T (Rotor SIN anillo azul)                      Alegra® WE-56E (Rotor CON anillo azul)      Alegra® WE-56 LED                      Alegra® WE-56 (Rotor SIN anillo azul)      Alegra® WE-56A</p> <p><b>Ref.: HE-764</b></p>	<p>Utilizable con llave HE-751 y llaves dinámicas HE-2025 y HE-2026</p> <p><b>13<sup>80</sup>€</b></p>

	Descripción	Observaciones
	Llave Tapa cabeza contra ángulos: Synea® WA-99A (desde 2007) Synea® WA-99LT (desde 2007) Fusion® WG-99LT (N/S-007802) Vision® WK-99LT (N/S-01001) <b>Ref.: HE-820</b>	34'80€
	Llave Tapa cabeza contra ángulos: Trend® WD-56 Synea® WA-56LT (hasta 2007) Synea® WA-99A/99LT (hasta 2007) <b>Ref.: HE-842</b> (Ref. W&H®: C-549)	39'80€
	Llave Tapa cabeza contra ángulos: WS-75 WS-75 E/KM (N/S-025335) WS-75 E/KM (N/S-30000) WI-75 E/KM WI-75 LED G WS-75 LED G <b>Ref.: HE-844</b> (Ref. W&H®: C-712)	39'80€
	<b>Lado A (hexagonal):</b> Para modelos NSK®, ver sección NSK® <b>Lado B (dos puntos):</b> Eje WI-75 Para modelos NSK®, ver sección NSK® <b>Ref.: HE-616</b>	Llave doble 34'80€
	Llave especial desmontaje eje intermedio WS-75 WD-56 Para modelos NSK®, ver sección NSK® <b>Ref.: HE-950</b>	38'80€
	Llave anillo de cierre contra ángulos Fusión® WG-56A                      Fusión® WG-99A Fusión® WG-56A LT <b>Ref.: HE-622</b>	3 muescas Contra ángulos sin fibra óptica 28'00€
	<b>Lado A (3 Muecas) - Tapa cabeza contra ángulo:</b> Fusión® WG-56 <b>Lado B (2 Muecas) - Eje cabeza contra ángulo:</b> Fusión® WG-56 <b>Ref.: HE-623</b>	Llave doble 28'00€
	<b>Lado A (3 Muecas) - Tapa cabeza contra ángulo:</b> Fusión® WG-99 <b>Lado B (2 Muecas) - Eje cabeza contra ángulo:</b> Fusión® WG-99 <b>Ref.: HE-624</b>	Llave doble 28'00€
	Llave desmontaje pieza intermedia contra ángulos series: Fusión® WG-56                      Fusión® WG-99 <b>Ref.: HE-625</b>	¡Advertencia! Los dientes deben ser encajados correctamente para evitar rotura de llave y/o eje. 28'00€
	Llave desmontaje rodamientos ejes contra ángulos Fusión® WG-99 <b>Ref.: HE-626</b>	28'00€





	Descripción	Observaciones
	<p>Llave cuerpo contra ángulo WE-xx LED G</p> <p><b>Ref.: HE-627</b> (Ref. W&amp;H®: C-615, C-1081)</p>	<p>24'80€</p>
	<p>Llave anillo cierre contra ángulos WE-xx LED G</p> <p><b>Ref.: HE-628</b> (Ref. W&amp;H®: C-411)</p>	<p>24'80€</p>

▶ Llaves para contra-ángulos y piezas de mano **NSK®**

RUMAR

	Descripción	Observaciones
	<p><b>Lado A (hexagonal):</b> Tapa-Botón S-Max SG20 Tapa-Botón S-Max SG20L Tapa-Botón Ti-Max X-SG20L Tapa-Botón Ti-Max X-DSG20L</p> <p><b>Lado B (dos puntos):</b> Eje S-Max SG20 Eje S-Max SG20L Eje Ti-Max X-SG20L Eje Ti-Max X-DSG20L Para modelos W&amp;H®, ver sección W&amp;H®</p> <p><b>Ref.: HE-616</b></p>	<p>Llave doble</p> <p>34'80€</p>
	<p><b>Lado A (hexagonal):</b> Ver sección W&amp;H® para otros modelos</p> <p><b>Lado B (cuadrada):</b> Cabezas FPB-Y S-Max M25 S-Max M25L</p> <p>Ver sección Sirona® para otros modelos</p> <p><b>Ref.: HE-610</b></p>	<p>Llave doble</p> <p>39'80€</p>
	<p>Llave Tapa cabeza contra ángulos: Ti-Max Ti25 Ti-Max Ti25L</p> <p><b>Ref.: HE-613</b></p>	<p>9'80€</p>
	<p><b>Lado A (9,57mm hexagonal):</b> Ti-Max X95 Ti-Max X95L S-Max M95 S-Max M95L</p> <p><b>Lado B (8,65mm hexagonal):</b> Ti-Max Z95 Ti-Max Z95L</p> <p><b>Ref.: HE-615</b></p>	<p>Llave doble</p> <p>23'80€</p>
	<p>Llave Tapa cabeza contra ángulos: MP-F MPA-Y MPAS-Y</p> <p><b>Ref.: HE-845</b></p>	<p>34'80€</p>
	<p>Llave Tapa cabeza contra ángulos: FX15 FX25 FX23</p> <p><b>Ref.: HE-839</b></p>	<p>38'00€</p>
	<p>Llave desmontaje eje central contra ángulos NSK®: S-Max M25L S-Max M65L S-Max M95L</p> <p>Ti-Max X25L Ti-Max X65L Ti-Max X95L</p> <p>Ti-Max Z25L Ti-Max Z95L</p> <p><b>Ref.: HE-2011BT</b> (Ref. KaVo®: 0.411.1881)</p>	<p>39'30€</p>



Llaves para contra-ángulos y piezas de mano **Sirona®**

	Descripción	Observaciones
	<p><b>Lado A (hexagonal):</b> Ver sección W&amp;H® para otros modelos</p> <p><b>Lado B (cuadrada):</b> X-Smart 6:1 Ver sección NSK® para otros modelos</p> <p><b>Ref.: HE-610</b></p>	<p>Llave doble</p> <p><b>39´80€</b></p>
	<p>Llave Tapa cabeza contra ángulos: Dentsply X-Smart 16:1</p> <p><b>Ref.: HE-845</b></p>	<p><b>34´80€</b></p>
	<p>Alicata tapa cabezas contra ángulos Sirona® <b>standard</b></p> <p><b>Ref.: HE-818</b> (Ref. Sirona®: 4178054)</p>	<p><b>98´00€</b></p>
	<p>Alicata tapa cabezas contra ángulos Sirona® <b>mini</b></p> <p><b>Ref.: HE-821</b> (Ref. Sirona®: 5986208)</p>	<p><b>98´00€</b></p>
	<p>Alicata doble tapa cabezas contra ángulos Sirona® <b>mini y standard</b></p> <p><b>Ref.: HE-761</b></p>	<p>Alicata doble</p> <p><b>38´00€</b></p>

Llaves para contra-ángulos y piezas de mano **Bien Air®**

	Descripción	Observaciones						
	<p>Llave Tapa cabeza contra ángulos:</p> <table border="0"> <tr> <td>1:1</td> <td>1:5 L</td> <td>20:1 L</td> </tr> <tr> <td>1:1 L</td> <td>20:1</td> <td></td> </tr> </table> <p><b>Ref.: HE-849</b> (Ref. Bien Air®: 3600083)</p>	1:1	1:5 L	20:1 L	1:1 L	20:1		<p><b>48´00€</b></p>
1:1	1:5 L	20:1 L						
1:1 L	20:1							

Llaves para contra-ángulos y piezas de mano **Castellini®**



	Descripción	Observaciones
	<p>Llave Tapa cabeza contra ángulos: Goldspeed S1 Goldspeed SIL</p> <p><b>Ref.: HE-833</b></p>	<p><b>39´80€</b></p> <p>BAJO PEDIDO</p>
 <small>Imagen no disponible</small>	<p>Llave Tapa cabeza contra ángulos: EVO S1 EVO SIL</p> <p><b>Ref.: HE-834</b></p>	<p><b>39´80€</b></p> <p>BAJO PEDIDO</p>



## LLAVES ACOPLAMIENTOS

### Llaves para acoplamientos



KAVO RUMAR

	Descripción	Observaciones
 <p>RUMAR</p>	Kavo® Multiflex MK-dent® QC4014K MK-dent® QC5016K  <b>Ref.: HE-1029</b>	8´00.€
 <p>KAVO</p>	Mandril de desmontaje Kavo® Multiflex  ***Original KaVo***  MK-dent® QC4014K MK-dent® QC5016K  <b>Ref.: HE-911</b> (Ref. KaVo®: 411.3853)	87´50.€

## LLAVES PULIDORES BICARBONATO

### Llaves para pulidores bicarbonato

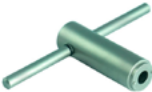
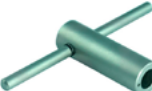
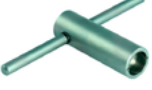
RUMAR

	Descripción	Observaciones
	MK-dent® PR1011 Micron Quick Jet BA Ultimate BA720  <b>Ref.: HE-2021K</b>	Sección acople KaVo®
	MK-dent® PR1011 Micron Quick Jet BA Ultimate BA720  <b>Ref.: HE-2021S</b>	Sección acople Sirona®
	MK-dent® PR1011 Micron Quick Jet BA Ultimate BA720  <b>Ref.: HE-2021W</b>	Sección acople W&H®
	MK-dent® PR1011 Micron Quick Jet BA Ultimate BA720  <b>Ref.: HE-2022</b>	<b>Llave 1</b>  Utilizable con llave HE-751 y llaves dinamométricas HE-2025 y HE-2026
	MK-dent® PR1011 Micron Quick Jet BA Ultimate BA720  <b>Ref.: HE-2023</b>	<b>Llave 2</b>  Utilizable con llave HE-751 y llaves dinamométricas HE-2025 y HE-2026

LLAVES PARA MICROMOTORES NOUVAG® PREGÚNTANOS

SI NO ENCUENTRAS EL REPUESTO QUE BUSCAS, ¡CONSÚLTANOS!  
 Precios: impuestos, portes y mano de obra no incluidos.

# HERRAMIENTAS DE MEDICIÓN Y DEMOSTRACIÓN

Herramientas de medición y demostración

RUMAR

## Descripción

## Observaciones

BAJADA  
PRECIO



**Dinamómetro digital** para medir la fuerza de retención de las pinzas de rotores de turbinas y contra ángulos multiplicadores

Ref.: HE-1020

68<sup>00</sup>€



### Contador móvil de revoluciones y frecuencias:

- Mide de 5.000 a 950.000 rpm.
- Mide frecuencias de 1 a 200.000 Hz.
- Display LED, numérica decimal.
- Medidas 76x118x18 mm.
- Peso 120 gr.
- Ideal para medir las rotaciones de cualquier instrumento rotatorio eléctrico o neumático y las frecuencias de cualquier ultrasonidos eléctrico o neumático.

MICRON®

Ref.: HE-100

1180<sup>00</sup>€



**Fresa** de turbina especial contador revoluciones Ref.: 45-100

**Diámetro:** 1,6mm

MICRON®

Ref.: HE-102

83<sup>00</sup>€



**Fresa** de contra-ángulo especial contador revoluciones Ref.: 45-100

**Diámetro:** 2,35mm

MICRON®

Ref.: HE-103

83<sup>00</sup>€



**Magneto** para puntas ultrasonido especial contador revoluciones Ref.: 45-100

MICRON®

Ref.: HE-104

39<sup>80</sup>€



**Sensor receptor** especial contador revoluciones Ref.: 45-100

MICRON®

Ref.: HE-105

148<sup>00</sup>€





**Microscopio** de bolsillo con LED 60X

RUMAR

Ref.: HE-754









31<sup>80</sup>€









	Descripción	Observaciones
 <p>METASYS</p>	<p><b>Manómetro digital</b> Metasys® con adaptadores</p> <ul style="list-style-type: none"> <li>- Es un instrumento de medición para presiones negativas y aire comprimido.</li> <li>- Permite la medición exacta de la presión de aspiración, aire y agua en sillones dentales.</li> </ul> <p>Ref.: HE-050005</p> <p>408<sup>00</sup>€</p>	<p>Rango de presiones: -1 a 30 bar</p>
 <p>RUMAR</p>	<p><b>Multimanómetro</b> para medición de consumo de:</p> <ul style="list-style-type: none"> <li>- Aire de empuje</li> <li>- Aire de retorno</li> <li>- Aire de spray</li> <li>- Agua de spray</li> </ul> <ul style="list-style-type: none"> <li>- Conexión Midwest 4.</li> <li>- Mediciones precisas en bares.</li> <li>- Compacto.</li> <li>- Uso en todos los equipos.</li> <li>- Acabados de primera calidad.</li> </ul> <p>Ref.: HE-101</p> <p>118<sup>00</sup>€</p>	
 <p>TKD</p>	<p><b>Manómetro</b> para aire de empuje:</p> <ul style="list-style-type: none"> <li>- Conexión Midwest 4 y Midwest 4 LUX</li> <li>- Doble escala de medición en PSI y bares.</li> <li>- Uso en todos los equipos.</li> <li>- Instrumento de primera calidad y precisión.</li> <li>- Uso: medición de presión de aire de empuje.</li> </ul> <p>Ref.: HE-208</p> <p>145<sup>80</sup>€</p>	

# HERRAMIENTAS DE REPARACIÓN TURBINAS Y CONTRA-ÁNGULOS

Herramientas de reparación turbinas y contra-ángulos

RUMAR



	Descripción	Observaciones
	<p><b>Prensa de precisión</b></p> <ul style="list-style-type: none"> <li>- Capacidad hasta 1,5kN.</li> <li>- Recorrido 40mm.</li> <li>- Altura de trabajo 50 – 240mm.</li> <li>- Medidas de la mesa: 110 x 60mm.</li> <li>- Orificio en la base: 20mm.</li> <li>- Alojamiento del eje: diámetro 10 x 25mm.</li> <li>- Peso: aprox. 9kg.</li> </ul> <p>Ref.: HE-2010</p>	<p><b>Nota:</b> herramientas HE-1031 y HE-1032 son necesarias para el uso de la prensa.</p> <p>698<sup>00</sup>€</p>
	<p><b>Extractor de rodamientos turbina</b>  <b>Diámetro exterior:</b> 6,350mm (universal) y pista interna con todos sus accesorios</p> <p>Ref.: HE-1011</p>	<p>198<sup>00</sup>€</p>
	<p><b>Pinza pista externa</b> para extractor HE-1011</p> <p>Ref.: HE-1011L</p>	<p>54<sup>80</sup>€</p>
	<p><b>Pinza pista interna</b> para extractor HE-1011</p> <p>Ref.: HE-1011S</p>	<p>54<sup>80</sup>€</p>
	<p><b>Tornillo ataque delantero</b> para extractor HE-1011</p> <p>Ref.: HE-1011SC</p>	<p>48<sup>00</sup>€</p> <p>HASTA AGOTAR</p>
	<p><b>Tornillo ataque trasero</b> para extractor HE-1011</p> <p>Ref.: HE-1011SO</p>	<p>48<sup>00</sup>€</p> <p>HASTA AGOTAR</p>
	<p><b>Extractor de rodamientos de turbina</b>  <b>Diámetro exterior:</b> 6,350mm (universal)  <b>Diámetro exterior:</b> 7,938mm (Bora y compatibles)                  Pista interna con todos sus accesorios</p> <p>Ref.: HE-260</p>	<p>168<sup>00</sup>€</p>
	<p><b>Bloque universal</b> de colocación y extracción de rodamientos</p> <p>Ref.: HE-1012</p>	<p>188<sup>80</sup>€</p>

	Descripción	Observaciones												
	<p><b>Punta ataque trasero</b> para prensa HE-2010</p> <p>Ref.: HE-1031</p> <p>42'80€</p>													
	<p><b>Punta ataque delantero</b> para prensa HE-2010</p> <p>Ref.: HE-1032</p> <p>42'80€</p>													
	<p><b>Llave dinamométrica</b> para tapas cabezas y tapas spray</p> <p>Ref.: HE-2025</p> <p>118'00€</p>	<p>Regulable: 0,3 – 1,2 Nw</p> <p>BAJO PEDIDO</p>												
	<p><b>Llave dinamométrica</b> para anillos cierre contra ángulos y piezas de mano</p> <p>Ref.: HE-2026</p> <p>118'00€</p>	<p>Regulable: 1,2 – 3,0 Nw</p> <p>BAJO PEDIDO</p>												
	<p><b>Pletina de extracción</b> rodamientos de turbinas</p> <p>Ref.: HE-750</p> <p>8'80€</p>													
	<p><b>Placa extracción</b> de rodamientos turbinas</p> <p>Ref.: HE-2018</p> <p>48'80€</p>													
	<p><b>Placa extracción de rodamientos universal:</b></p> <table border="0"> <tr> <td>1,0mm</td> <td>3,0mm</td> <td>5,0 mm</td> </tr> <tr> <td>1,5 mm</td> <td>3,5 mm</td> <td>6,5 mm</td> </tr> <tr> <td>2,0 mm</td> <td>4,0 mm</td> <td>7,0 mm</td> </tr> <tr> <td>2,5 mm</td> <td>4,5 mm</td> <td></td> </tr> </table> <p>Ref.: HE-2017</p> <p>157'80€</p>	1,0mm	3,0mm	5,0 mm	1,5 mm	3,5 mm	6,5 mm	2,0 mm	4,0 mm	7,0 mm	2,5 mm	4,5 mm		
1,0mm	3,0mm	5,0 mm												
1,5 mm	3,5 mm	6,5 mm												
2,0 mm	4,0 mm	7,0 mm												
2,5 mm	4,5 mm													
	<p><b>Pinza de Baquelita</b> para sujeción de piezas rotatorio sin rayaduras.</p> <p>Ref.: HE-760</p> <p>54'80€</p>													

# HERRAMIENTAS DE DESATASCO

Smart Cleaner®

RUMAR

	Descripción	Observaciones
	<p>Herramienta especial para desatascar todo tipo de rotatorios y mangueras de turbinas.</p> <ul style="list-style-type: none"> <li>- Trabaja con presiones de hasta 40 bares.</li> <li>- Completo con todos los accesorios:                             <ul style="list-style-type: none"> <li>* Conexión Midwest 4 con luz para acoplamiento, turbinas, micromotores y otros.</li> <li>* Conector sistema INTRA para contra-ángulos y piezas de mano.</li> <li>* Conector para mangueras de turbina!!! **</li> <li>* Accesorio para turbinas con varios orificios de spray.</li> </ul> </li> </ul>	<p><b>** Nota a nuestros clientes:</b> Es posible que encuentren el Smart Cleaner® más barato en algunos competidores. Por lo general, es porque NO incluyen el adaptador para mangueras de turbina.</p> <p><b>¡Asegúrense de consultarlo antes!</b></p>
	<p>Anillo tórico pistón Smart Cleaner®</p>	

Ref.: HE-020

338<sup>00</sup>€

Ref.: HE-021

0<sup>80</sup>€

# EMBALAJES

Embalajes

RUMAR

NUEVO DISEÑO

QUICK LOCK

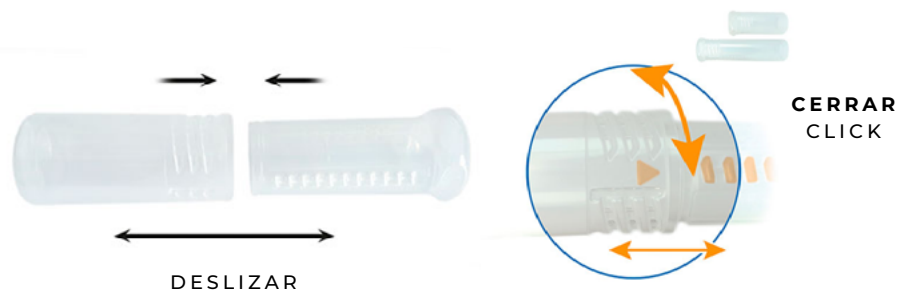

	Descripción	Observaciones
	<p>Tubo embalaje instrumentos transparente (SIN LOGOS)</p> <p>Más fácil, rápido y seguro Precios especiales por packs 100 uds.</p>	<p><b>Longitud:</b> 80-120mm <b>Diámetro:</b> 26mm</p>
	<p>Tubo embalaje instrumentos transparente (SIN LOGOS)</p> <p>Más fácil, rápido y seguro Precios especiales por packs 100 uds.</p>	<p><b>Longitud:</b> 120-200mm <b>Diámetro:</b> 24mm</p>

Ref.: 01-26080

1<sup>10</sup>€

Ref.: 01-24120

1<sup>20</sup>€

Precios especiales por packs 100 uds.